

**DOKUZ EYLÜL UNIVERSITY
GRADUATE SCHOOL OF NATURAL AND APPLIED
SCIENCES**

**A FUZZY RULE BASED EXPERT SYSTEM FOR
STOCK EVALUATION AND PORTFOLIO
CONSTRUCTION: AN APPLICATION TO
ISTANBUL STOCK EXCHANGE**

by

Mualla Gonca YUNUSOĞLU

January, 2012

İZMİR

**A FUZZY RULE BASED EXPERT SYSTEM FOR
STOCK EVALUATION AND PORTFOLIO
CONSTRUCTION: AN APPLICATION TO
ISTANBUL STOCK EXCHANGE**

**A Thesis Submitted to the
Graduate School of Natural and Applied Sciences of Dokuz Eylül University
In Partial Fulfillment of the Requirements for the Degree of Master of Science
in Industrial Engineering, Industrial Engineering Program**

**by
Mualla Gonca YUNUSOĞLU**

January, 2012

İZMİR

M.Sc THESIS EXAMINATION RESULT FORM

We have read the thesis entitled "A FUZZY RULE BASED EXPERT SYSTEM FOR STOCK EVALUATION AND PORTFOLIO CONSTRUCTION: AN APPLICATION TO ISTANBUL STOCK EXCHANGE" completed by MUALLA GONCA YUNUSOĞLU under supervision of ASST.PROF.DR. HASAN SELİM and we certify that in our opinion it is fully adequate, in scope and in quality, as a thesis for the degree of Master of Science.

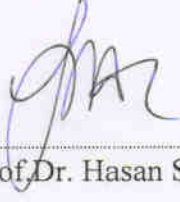

Asst.Prof.Dr. Hasan SELİM

Supervisor



Assoc. Prof. Dr. Bilge Bilgen Ekrem DEMURECİ

(Jury Member)

(Jury Member)

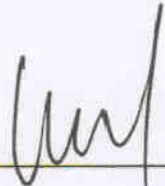

Prof.Dr. Mustafa SABUNCU

Director

Graduate School of Natural and Applied Sciences

ACKNOWLEDGMENTS

First of all, I would like to express my sincere gratitude to Asst. Prof. Hasan Selim, for his guidance, support and understanding. He not only served as my supervisor but also encouraged me throughout my graduate and undergraduate programs. He always supported my decisions and gave me freedom in my research while helping me to overcome challenges and giving advices.

Additionally, I am grateful to Mehmet Demir for his invaluable support and suggestions. He always shared his professional knowledge with me unrequitedly. As a practitioner, he provided lots of contributions to my thesis.

This research has been supported by Dokuz Eylül University under Grant 2011.KB.FEN.021.

I would also like to express my thanks to all professors and colleagues in the Industrial Engineering Department of Dokuz Eylül University for their support, encouragement and tolerance.

Finally, I would like to express my special thanks to my parents, Hülya and Kemal Yunusoğlu, and my sister Pınar Yunusoğlu for their love, patience and encouragement. Without their trust and moral support, this thesis would not have been possible.

Mualla Gonca Yunusoğlu

A FUZZY RULE BASED EXPERT SYSTEM FOR STOCK EVALUATION AND PORTFOLIO CONSTRUCTION: AN APPLICATION TO ISTANBUL STOCK EXCHANGE

ABSTRACT

The aim of this study is to construct an appropriate portfolio by taking investor's preferences and risk profile into account in a realistic, flexible and practical manner. In this concern, a fuzzy rule based expert system is developed to support portfolio managers in their middle term investment decisions. The proposed expert system consists of three stages. In the first stage, the stocks that are not preferred by investors are eliminated according to some fundamental thresholds and specific preferences of investor. In the second stage, the stocks are evaluated and rated by using a fuzzy rule base. In the last stage, a portfolio that is appropriate to the investor's risk profile and preferences is constructed by using the stock ratings.

The proposed expert system is validated for the period between 2002 and 2010, by using the data of 61 stocks that are publicly traded in Istanbul Stock Exchange National-100 Index and are never left out of Istanbul Stock Exchange during the validation period. The performance of the proposed system is analyzed in comparison with the benchmark index, Istanbul Stock Exchange National-30 Index, in terms of different risk profiles and investment period lengths. In most cases, the performance of the proposed expert system is superior relative to the benchmark index. However, the performance is inferior in a few periods in which unpredictable macroeconomic or political events occur. Additionally, in parallel to our expectations, the performance of the expert system is relatively higher in case of risk-averse investor profile and middle term investment period than the performance observed in the other cases.

Keywords: Financial risk management, portfolio management, stock evaluation, multi-criteria decision making, fuzzy rule based expert systems, Istanbul Stock Exchange

HİSSE SENEDİ DEĞERLENDİRME VE PORTFÖY OLUŞTURMA İÇİN BİR BULANIK KURAL TABANLI UZMAN SİSTEM: İSTANBUL MENKUL KIYMETLER BORSASI'NDA BİR UYGULAMA

ÖZ

Bu çalışmanın amacı, yatırımcının tercihlerini ve risk profiline uygun bir portföyü gerçekçi, esnek ve pratik bir şekilde oluşturmaktır. Bu bağlamda, portföy yöneticilerini orta vadeli yatırım kararlarında destekleyecek bir bulanık kural tabanlı uzman sistem geliştirilmiştir. Önerilen uzman sistem üç aşamadan oluşur. İlk aşamada, yatırımcılar tarafından tercih edilmeyen hisse senetleri, bazı temel eşik değerleri ve yatırımcının özel tercihleri temel alınarak sistemden çıkarılır. İkinci aşamada, hisse senetleri bir bulanık kural tabanı kullanılarak değerlendirilir ve derecelendirilir. Son aşamada ise, hisse senedi dereceleri kullanılarak yatırımcının risk profiline ve tercihlerine uygun bir portföy oluşturulur.

Önerilen uzman sistemin geçerliliği 2002 ile 2010 yılları arasında İstanbul Menkul Kıymetler Borsası'nda işlem görmüş ve İstanbul Menkul Kıymetler Borsası Ulusal 100 Endeksi'nde yer alan 61 hisse senedine ilişkin veriler kullanılarak 2002 ile 2010 yılları arasındaki dönem için onaylanmıştır. Önerilen sistemin performansı farklı risk profilleri ve farklı yatırım periyodu uzunlukları için kıyas endeksi olarak kullanılan İstanbul Menkul Kıymetler Borsası Ulusal 30 Endeksi ile karşılaştırmalı olarak analiz edilmiştir. Önerilen sistemin performansı birçok durumda kıyas endeksine göre üstün bulunmuştur. Ancak, öngörülemeyen makroekonomik ve politik olayların gerçekleştiği birkaç periyotta önerilen sistemin performansı kıyas endeksine göre düşük bulunmuştur. Ayrıca, beklentilerimize paralel olarak, riski sevmeyen yatırımcı profili ve orta vadeli yatırım durumlarında önerilen sistemin performansının diğer durumlara göre yüksek olduğu gözlenmiştir.

Anahtar sözcükler: Finansal risk yönetimi, portföy yönetimi, hisse senedi değerlendirme, çok kriterli karar verme, bulanık kural tabanlı uzman sistemler, İstanbul Menkul Kıymetler Borsası

CONTENTS

	Page
M.Sc THESIS EXAMINATION RESULT FORM.....	ii
ACKNOWLEDGMENTS	iii
ABSTRACT.....	iv
ÖZ	v
CHAPTER ONE - INTRODUCTION	1
CHAPTER TWO - RELATED LITERATURE	4
CHAPTER THREE - PORTFOLIO MANAGEMENT.....	18
3.1 Modern Portfolio Theory	18
3.1.1 Markowitz Portfolio Theory	19
3.1.1.1 Measurement of Return and Risk.....	19
3.1.1.2 The Portfolio Standard Deviation Formula.....	21
3.1.1.3 The Efficient Frontier and Optimal Portfolio.....	22
3.1.1.4 Risk-Free Asset and Risk-Free Rate of Return	25
3.1.1.5 Market Portfolio and Diversification	25
3.1.2 Efficient Market Hypothesis	26
3.2 Fundamental Analysis.....	27
3.2.1 Liquidity Analysis.....	29
3.2.2 Profitability Analysis	30
3.2.3 Marketability Analysis.....	31
3.2.4 Financial Risk Analysis	32
3.3 Technical Analysis.....	34
3.3.1 Moving Average Indicators.....	35
3.3.2 Momentum Indicators	38
3.3.3 Breakout Indicators	39
3.3.4 Oscillators	43
3.3.5 Volume Indicators.....	46
3.4 Portfolio Performance Evaluation.....	48

3.4.1	Treynor Ratio	49
3.4.2	Sharpe Ratio	50
3.4.3	Jensen's Alpha	50
3.4.4	Information Ratio	51

CHAPTER FOUR - EXPERT SYSTEMS..... 53

4.1	ES Application Domains.....	54
4.2	Appropriate Problem Structures for ES	57
4.3	ES Structure	58
4.4	Knowledge Acquisition.....	60
4.4.1	Interviews	60
4.4.2	Task Performance Observations	62
4.4.3	Questionnaires.....	63
4.5	Knowledge Representation	63
4.5.1	Semantic Networks	64
4.5.2	Frames	65
4.5.3	Predicate Logic.....	65
4.5.4	Production Rules	66
4.6	Inference Techniques	68
4.6.1	Forward Chaining	68
4.6.2	Backward Chaining.....	69
4.7	Approximate Reasoning.....	70
4.7.1	Fuzzy Sets	70
4.7.2	Fuzzification.....	74
4.7.3	Linguistic Variables	75
4.7.4	Fuzzy Inference.....	77
4.7.4.1	Mamdani Inference Technique	78
4.7.4.2	Takagi-Sugeno Inference Technique	81
4.7.4.3	Tsukamoto Inference Technique	82

CHAPTER FIVE - THE PROPOSED EXPERT SYSTEM FOR STOCK EVALUATION AND PORTFOLIO CONSTRUCTION	84
5.1 Stage 1: Elimination of Unacceptable Stocks	84
5.2 Stage 2: Stock Evaluation	85
5.3 Stage 3: Portfolio Construction	93
CHAPTER SIX - APPLICATION	96
6.1 Performance Evaluation for Different Risk Profiles.....	99
6.2 Performance Evaluation for Different Investment Period Lengths.....	109
CHAPTER SEVEN - CONCLUSION	114
REFERENCES	115
APPENDICES	121

CHAPTER ONE

INTRODUCTION

Portfolio management process is an integrated set of steps undertaken in a consistent manner to create and maintain an appropriate portfolio (combination of assets) to meet clients' goals. A portfolio should be suitable to investor's risk profile and specific preferences. However, considering these factors makes the problem more complex and subjective.

The aim of this study is constructing an appropriate portfolio that meets investor's risk profile and specific preferences, rather than constructing an optimal portfolio that is just a collection of individual assets having desirable risk-return characteristics. The problem is divided into two stages, namely, stock evaluation and portfolio construction, as many researchers have done in their recent studies. In the first stage, stocks are evaluated through both fundamental and technical criteria and rated according to their performance. On the other hand, in the second stage a portfolio that is suitable to investor's preferences and risk profile is recommended by taking the stock ratings into account. However, the problem is still highly complex and unstructured. Additionally, since only partial information is available about the market, there exists high level of uncertainty. Moreover, the relationships between fundamental and technical criteria are uncertain. Due to these characteristics of the problem, a fuzzy rule based expert system (ES) is thought to be an appropriate framework for the solution. Considering these facts, a fuzzy rule based ES is developed in this study to support portfolio managers in their middle term investment decisions in a realistic, flexible and practical manner.

The ES proposed in this research consists of three stages; elimination of unacceptable stocks, stock evaluation and portfolio construction. In the first stage, the stocks that are not preferred by investors are eliminated according to some fundamental thresholds and specific preferences of investor. This stage reduces the burden on the stock evaluation process, and also prevents the system to suggest an undesirable stock to the investor. In the second stage, the stocks are evaluated and

rated by using a fuzzy rule base. In the last stage, a portfolio that is appropriate to the investor's risk profile and preferences is constructed by taking the stock ratings into account.

It is observed that most of the studies use just fundamental criteria or just technical measures in stock evaluation problem. In contrast, both fundamental and technical measures are used in this study in evaluating stocks more accurately. On the other hand, in some of the previous research, industrial characteristics of the stocks are taken into account in the stock evaluation. However, in these studies, distinct rule bases are used for each industry class, and they bring a burden for the ES. In addition, different stock rankings obtained for each industry may be confusing in portfolio construction stage. In order to overcome this complexity, the fundamental ratios relative to the corresponding industry averages are used in this study. Through the use of relative fundamental ratios, the stocks can be evaluated by a single procedure and a unique stock ranking can be obtained by considering industrial characteristics of the stocks.

The proposed expert system is validated for the period between 2002 and 2010, by using the data of 61 stocks that are publicly traded in Istanbul Stock Exchange (ISE) National-100 Index (XU100) and are never left out of ISE during the validation period. The performance of the proposed ES is analyzed in comparison with the benchmark index, ISE National-30 Index (XU030), in terms of different risk profiles and investment period lengths. In most cases, the performance of the proposed ES is superior relative to the benchmark index. However, the performance is inferior in a few periods in which unpredictable macroeconomic or political events occur. Additionally, in parallel to our expectations, the performance of the ES is relatively higher in case of *risk-averse investor profile* and *middle term investment period* than the performance observed in the other cases.

The remainder of this study is organized as follows. In Chapter 2, a comprehensive literature review in the domain of this study is presented. In Chapter 3, modern portfolio theory (MPT), fundamental and technical analyses, and portfolio

performance measures are explained. Chapter 4 is devoted to the description and explanation of ES technology, fuzzy sets theory and approximate reasoning. In Chapter 5, structure of the proposed ES is explained in detail. In Chapter 6, performance of the proposed ES is analyzed by using the historical data obtained from ISE in cases of different risk profiles and investment period lengths. Finally, in Chapter 7, concluding remarks are presented.

CHAPTER TWO

RELATED LITERATURE

Modern Portfolio Theory, as an important research area of modern finance theory, has born from the study of Markowitz published in 1952. Markowitz showed that the variance of the rate of return was a meaningful measure of portfolio risk under a set of assumptions, and he derived the formula for computing the variance of a portfolio. The Markowitz model is based on several assumptions regarding investor behavior (Reilly & Brown, 2004):

- Investors consider each investment alternative as being represented by a probability distribution of expected returns over some holding period.
- Investors maximize one-period expected utility, and their utility curves demonstrate diminishing marginal utility of wealth.
- Investors estimate the risk of the portfolio on the basis of the variability of expected returns.
- Investors base decisions solely on expected return and risk, so their utility curves are a function of expected return and the expected variance (or standard deviation) of returns only.
- For a given risk level, investors prefer higher returns to lower returns. Similarly, for a given level of expected return, investors prefer less risk to more risk.

The basic Markowitz mean-variance model can be written as a biobjective quadratic program as follows:

$$\max \sum_{i=1}^N w_i r_i, \quad (2.1)$$

$$\min \sigma_p = \sqrt{\sum_{i=1}^N w_i^2 \sigma_i^2 + \sum_{i=1}^N \sum_{j=1}^N w_i w_j Cov_{ij}}, \quad i \neq j \quad (2.2)$$

s.t.

$$\sum_{i=1}^N w_i = 1, \quad (2.3)$$

$$w_i \geq 0, \quad i = 1, \dots, n. \quad (2.4)$$

Here, N denotes the number of available assets, w_i represents the weight of each individual asset i in the portfolio determined by the proportion of value in the portfolio, r_i denotes the expected return of individual asset i , σ_p is the variance of the portfolio as a measure of portfolio risk proposed by Markowitz, Cov_{ij} represents covariance between returns of individual assets i and j .

Eq. 2.1 maximizes portfolio's total rate of return. Eq. 2.2 minimizes the portfolio's risk. Portfolio risk has two components: variances of individual assets and covariances between pairs of individual assets in the portfolio. Hence, the portfolio risk formula includes both systematic risk (β) and unsystematic risk. Eqs. 2.3 and 2.4 ensure that all of the available capital is invested and weights of assets are nonnegative.

Following the development of MPT by Markowitz, two major theories have been put forth for the valuation of risky assets: Capital Market Theory and its product Capital Asset Pricing Model (CAPM) introduced by Sharpe (1964) and Arbitrage Pricing Theory (APT) introduced by Ross (1976). CAPM, that determines the expected rate of return for any risky asset, is a result of capital market theory. Due to capital market theory builds on the Markowitz portfolio model, it requires the same assumptions, along with some additional ones (Reilly & Brown, 2004):

- All investors are Markowitz efficient investors who want to target points on the efficient frontier. The exact location on the efficient frontier and, therefore, the specific portfolio selected will depend on the individual investor's risk-return utility function.
- Investors can borrow or lend any amount of money at the risk-free rate of return (RFR). Clearly, it is always possible to lend money at the nominal RFR

by buying risk-free securities such as government T-bills. It is not always possible to borrow at this RFR, but we will see that assuming a higher borrowing rate does not change the general results.

- All investors have homogeneous expectations; that is, they estimate identical probability distributions for future rates of return. Again, this assumption can be relaxed. As long as the differences in expectations are not vast, their effects are minor.
- All investors have the same one-period time horizon such as one month, six months, or one year. The model will be developed for a single hypothetical period, and its results could be affected by a different assumption. A difference in the time horizon would require investors to derive risk measures and risk-free assets that are consistent with their investment horizons.
- All investments are infinitely divisible, which means that it is possible to buy or sell fractional shares of any asset or portfolio. This assumption allows us to discuss investment alternatives as continuous curves. Changing it would have little impact on the theory.
- There are no taxes or transaction costs involved in buying or selling assets. This is a reasonable assumption in many instances. Neither pension funds nor religious groups have to pay taxes, and the transaction costs for most financial institutions are less than 1 percent on most financial instruments. Again, relaxing this assumption modifies the results, but it does not change the basic thrust.
- There is no inflation or any change in interest rates, or inflation is fully anticipated. This is a reasonable initial assumption, and it can be modified.
- Capital markets are in equilibrium. This means that we begin with all investments properly priced in line with their risk levels.

According to the capital market theory, the return for the market portfolio (R_M) should be consistent with its own risk, which is the covariance of the market with itself. In the sense of this notion, expected return of an individual asset is linearly dependent to its covariance with the market portfolio and the following equation is derived:

$$E(R_i) = RFR + \beta_i (R_M - RFR) \quad (2.5)$$

Here, $E(R_i)$ is the expected rate of return on individual risky asset i , RFR is the risk-free rate of return, R_M is the return for the market portfolio. $\beta_i = Cov_{i,M}/\sigma_M^2$ represents the β of individual asset i . β is a standardized measure of risk because it relates covariance between asset i and market portfolio to the variance of the market portfolio. As a result, the market portfolio has a β of 1. Therefore, if the β for an asset is above 1.0, the asset has higher β than the market, which means that it is more volatile than the overall market portfolio.

After computing the expected rate of return for a specific risky asset using Eq. 2.5, we can compare this expected rate of return to the asset's estimated rate of return over a specific investment horizon to determine whether it would be an appropriate investment. In order to make this comparison, an independent estimate of the return must be accomplished for each individual asset using either fundamental or technical analysis techniques. If there are any difference between estimated return and expected return, it means there is an excess return for the stock, referred to as a stock's alpha. This alpha can be positive (the stock is undervalued) or negative (the stock is overvalued). If the alpha is zero, the stock is properly valued in line with its β (Reilly & Brown, 2004).

The CAPM has been one of the most useful and frequently used models the financial theories ever developed. However, many of the empirical studies also point out some of the deficiencies in the model as an explanation of the link between risk and return. For example, tests of the CAPM indicated that the β s for individual securities were not stable but that portfolio β s generally were stable assuming long enough sample periods and adequate trading volume. There was mixed support for a positive linear relationship between rates of return and β for portfolios of stock, with some recent evidence indicating the need to consider additional risk variables or a need for different risk proxies. In addition, several papers criticized the tests of the model and the usefulness of the model in portfolio evaluation because of its

dependence on a market portfolio of risky assets that is not currently available (Reilly & Brown, 2004).

Most of the studies on CAPM are concentrated on whether it is possible to use knowledge of certain firm or security characteristics to develop profitable trading strategies, even after adjusting for investment risk as measured by β . An example to these is the study of Banz (1981) who showed that portfolios of stocks with low market capitalizations outperformed “large” stock portfolios on a risk-adjusted basis. In addition, Fama & French (1992) demonstrated that *value stocks* (i.e., those with high book value-to-market price ratios) tend to produce larger risk-adjusted returns than *growth stocks* (i.e., those with low book-to-market ratios). Of course, in an efficient market, these return differentials should not occur. Therefore, researchers are focused on the deficiency of the single-factor models such as the CAPM in measuring risk. As a result, APT was developed by Ross in 1976 with three major assumptions (Reilly & Brown, 2004):

- Capital markets are perfectly competitive,
- Investors always prefer more wealth to less wealth with certainty,
- The stochastic process generating asset returns can be expressed as a linear function of a set of K risk factors (or indexes).

The following major assumptions of CAPM are not required by APT:

- Investors possess quadratic utility functions,
- Normally distributed security returns,
- A market portfolio that contains all risky assets and is mean-variance efficient.

According to APT, the stochastic process generating asset returns can be represented as a K factor model in the form:

$$R_i = E(R_i) + b_{i1}\delta_1 + b_{i2}\delta_2 + \dots + b_{ik}\delta_k + \varepsilon_i \quad \text{for } i = 1, \dots, n. \quad (2.6)$$

Here, n is the number of assets. R_i is the actual return on asset i during a specified time period. $E(R_i)$ is the expected return for asset i if all the risk factors remain unchanged. b_{ij} is the reaction in asset i 's returns to movements in a common risk factor j . δ_k is the k th factor or index with a zero mean that influences the returns on all assets. ε_i is a unique effect on the return of asset i (i.e., a random error term that, by assumption, is completely diversifiable in large portfolios and has a mean of zero).

As indicated, δ terms are the multiple risk factors expected to have an impact on the returns of all assets. Examples of these factors might include inflation, growth in gross domestic product (GDP), major political upheavals, or changes in interest rates. APT asserts that there are many such factors that affect returns in contrast to the CAPM, where the only relevant risk to measure is the covariance of the asset with the market portfolio. However, the factors are not identified by the theory. Nevertheless, a wide variety of empirical factor specifications have been employed in practice. Two general approaches have been employed in factor identification. First, risk factors can be macroeconomic in nature; that is, they can attempt to capture variations in the underlying reasons an asset's cash flows and investment returns might change over time (e.g., changes in inflation or real GDP growth). On the other hand, risk factors can also be identified at a microeconomic level by focusing on relevant characteristics of the securities themselves, such as the size of the firm and some of its financial ratios (Reilly & Brown, 2004).

As stated above, MPT has been widely accepted and studied by researchers. However, in recent years, criticism on the assumptions of MPT is increasing. The basic assumption of MPT is the efficiency of markets. However, Grossman and Stiglitz (1980) asserted that obtaining information about markets is costly and it is impossible to get whole information about each individual stock. Therefore, prices cannot perfectly reflect the information and markets cannot be efficient. Hence, it is very important to identify the undervalued stocks for investment. Technical and fundamental analyses are used for selecting the undervalued stocks in practice, and recently these analyses take researchers' attention. The studies done by Edirisinghe

& Zhang (2007), Xidonas, Mavrotas & Psarras (2009) and Hachicha, Jarboui & Siarry (2011) are the recent examples.

Another criticism on MPT is the computational burden caused by the quadratic utility functions and covariance matrix. This burden causes challenging difficulties in real life applications due to the high number of stocks. That is why investors prefer to use simplified investment rules, instead of the models in the field of MPT. However, the portfolio management process is divided into two stages in recent studies to reduce the initial number of stocks and consequently reduce the computational difficulty. In the first stage, appropriate stocks for portfolio construction are selected. In the second stage, the amount of capital to be invested in each stock selected in the first stage is specified. The study of Xidonas, Askounis & Psarras (2009) is a good example to this two- stage process.

Finally, it is widely criticized that MPT disregards real investor's preferences. "In contrast to the often assumed utility maximizing individual with rational expectations, investors are not a homogeneous group" (Maringer, 2005). Moreover, it is often found in portfolio optimization that investors prefer portfolios that lie behind the efficient frontier of the Markowitz model even though they are dominated by other portfolios with respect to the two criteria, expected return and risk. This observation can be explained by the fact that not all the relevant information for an investment decision can be captured in terms of explicit return and risk (Ehrgott, Klamroth & Schwehm, 2004). Recently, most of the researchers regard investor's preferences and risk profile such as Samaras, Matsatsinis & Zopounidis (2008).

Despite of the criticisms, experience has proved that the classical approach (MPT) is useful, for instance concerning the diversification principle and the use of the β as the measure of risk. Thus, the use of the classical approach seems to be necessary but not sufficient in managing portfolio selection process efficiently. On the other hand, some additional criteria must be added to the classical risk-return criteria. In practice, these additional criteria can be found in fundamental analysis or constructed following the individual goals of the investor (Xidonas & Psarras, 2009). By

considering additional and/or alternative decision criteria, a portfolio that is dominated with respect to expected return and risk may make up for the deficit in these two criteria by a very good performance in one or several other criteria and thus be non-dominated in a multi-criteria setting (Ehrgott et al., 2004). As a result, portfolio management is a multidimensional problem and multi-criteria decision making (MCDM) approach provides the methodological basis to resolve the inherent multi-criteria nature of the problem.

MCDM approach builds realistic models by taking into account, apart from the two basic criteria; return and risk (mean-variance model), a number of important other criteria i.e. additional statistical measures of the variation of return, like the VaR (value at risk) and the skew measures, criteria that are founded in the theory of fundamental analysis, like the security's dividend yield (DY) and price to earnings ratio (P/E) or criteria related to the stock market characteristics and behavior of securities, like the capitalization rate, the β and alpha coefficients etc. (Xidonas, Mavrotas, Zopounidis & Psarras, 2011). Furthermore, MCDM, have the advantage of taking into account the preferences of any particular investor. Additionally, these methods do not impose any norm to the investor's behavior. The use of MCDM methods allows synthesizing in a single procedure the theoretical and practical aspects of portfolio management, and then it allows a non normative use of theory (Xidonas & Psarras, 2009). The studies done by Ho, Tsai, Tzeng & Fang (2011) and by Xidonas et. al. (2011) are the recent examples of MCDM applications on portfolio management. For more studies regarding the applications of MCDM methodologies on portfolio management, the reader may refer to Xidonas & Psarras (2009).

Portfolio management is a complex, subjective and generally unstructured process. Additionally, decision makers have partial information about the market and have to deal high level of uncertainty. Moreover, the interaction between fundamental and technical criteria is uncertain. Due to the complex, uncertain and unstructured nature of the problem, there is a growing interest in artificial intelligence (AI) techniques recently such as artificial neural networks (ANN), ESs, intelligent agents (IA) and hybrid intelligent systems (HIS).

From a general point of view, ANNs could be seen as information processing systems that use learning and generalization capabilities and are very adaptive. ANNs were used because of their numeric nature, no requirement to any data distribution assumptions for inputs, and capability of updating the data (Bahrammirzaee, 2010). “The main advantage of ANNs is that it can operate with incomplete data to generalize and demonstrate apparent intuition” (Metaxiotis, Ergazakis, Samouilidis & Psarras, 2003). The studies done by Fernandez & Gomez (2007) and by Freitas, De Souza & De Almeida (2009) are the recent ANN applications on portfolio management domain. The readers who are interested in more details regarding ANN applications on portfolio management may refer to Bahrammirzaee (2010).

Having the current number of financial tools, the number of possible portfolio mixes that can be synthesized is astronomical. To search for portfolio allocations that match the objectives and constraints of a fund manager is a hard and time-consuming process. A financial manager can delegate part of this task to an ES by connecting it to a financial databank. An ES is defined as a computer system, which contains a well-organized body of knowledge that imitates experts’ problem-solving skills in a limited domain of expertise (Bahrammirzaee, 2010). “Important advantages in using an ES are the uniformity and possibility of its improvement over time” (Nedović & Devedžić, 2002). Additionally, an ES is not based on black-box formulation like ANN and it is easier for users to understand its structure. The ES applications in portfolio management will be introduced in the following.

Another AI tool used for modeling portfolio management process is IAs in the field of distributed AI. According to Jennings & Wooldridge (1998), “an agent is a computer system situated in some environment, and that is capable of autonomous action in this environment in order to meet its design objectives.” The behavior of IAs can be modified dynamically due to learning or influence of other agents. IAs can be autonomous, can reason about themselves and can be mobile. They can actively and dynamically seek to cooperate to solve problems, using task and

domain-level protocols (Metaxiotis et al., 2003). The study of Kluger & McBride (2011) is an example to IA applications in portfolio management.

Recently, researchers are interested in modular structure of human brain and its hybridization capabilities and imitation of those by using HIS. It is an efficient and robust learning system which combines the complementary features and overcomes the weaknesses of the representation and processing capabilities of symbolic and nonsymbolic learning paradigms. HIS not only represents the combination of different intelligent techniques but also integrates intelligent techniques with conventional computer systems, spreadsheets and databases (Bahrammirzaee, 2010). The recent examples to HIS applications are the studies conducted by Chen & Huang (2009) and Quek, Yow, Cheng and Tan (2009). For more studies regarding the HIS applications in portfolio management, the reader may refer to Bahrammirzaee, (2010).

As stated previously, a fuzzy rule-based ES is developed in this thesis to support portfolio managers in their investment decisions. By using ES technology, it becomes possible to obtain more realistic, flexible and practical solutions to the stock evaluation and portfolio construction problem. In addition, an ES reduce the time required by portfolio managers for decision making, and standardize the decision making process. Consequently, the quality of the decision can be improved.

Since knowledge is not always readily available for an ES, it is essential to obtain the expert knowledge from a human expert. However, obtaining and representing knowledge for an ES may be challenging. “Just as there is no single theory to explain human knowledge organization or the best technique for structuring data in a conventional computer program, no single knowledge representation structure is ideal” (Durkin, 1994). There are numerous knowledge representation techniques for ESs in literature such as semantic networks, frames and production rules. In practice, the most commonly used technique is *production rules* known as *if-then rules*. Production rules are easy to understand and communicable, since they are a natural form of knowledge. “Rules can be viewed, in some sense, as simulation of the

cognitive behavior of human experts. According to this view, rules are not just a neat formalism to represent knowledge in a computer; rather, they represent a model of actual human behavior” (Turban & Aronson, 2001).

Human knowledge is often inexact. Sometimes we are only partly sure about the truth of a statement and still have to make educated guesses to solve problems. Therefore, some mathematical and statistical approaches are developed by researchers such as Bayesian statistics, Dempster and Shafer’s belief functions and fuzzy sets. Among these approaches, fuzzy sets and its consequence fuzzy logic is the most commonly used techniques in representing the uncertainty in ES. Fuzzy logic can be useful because it is an effective and accurate way to describe human perceptions of decision making problems. In a standard rule-based system, a production rule has no concrete effect at all, unless the data completely satisfy the antecedent of the rule. The operation of the system proceeds sequentially, with one rule firing at a time. If two rules are simultaneously satisfied a conflict resolution policy is needed to determine which one takes precedence. In a fuzzy rule-based system, in contrast, all rules are executed during each pass through the system, but with strengths ranging from *not at all* to *completely* depending on the relative degree to which their fuzzy antecedent propositions are satisfied by the data (Turban & Aronson, 2001).

Due to the characteristics of the problem handled in this study, a fuzzy rule-based ES is considered as an appropriate solution approach. The number of studies that use rule-based ESs in portfolio management is scarce. Additionally, in portfolio management domain, researchers compare with and validate by their ES only conventional methods since the nature of ESs is somehow different from that of other intelligent methods. This causes researchers to compare their proposed ES to conventional measures like existing indexes, expert’s opinion or real data (Bahrammirzaee, 2010).

The earliest study in this domain is the development of Port-Man (Chan, Dillon & Saw, 1989) that is an ES for portfolio management in banking system. The main goal

of this ES was to give advices to personal investment in a bank. In general, the consultation process of Port-Man was consisted of four stages; information acquisition, product selection, choice refinement and customer and target frame (Bahrammirzaee, 2010). In Port-Man, frames are the major components of knowledge representation, while production rules are used to represent the control knowledge of product selection. System parameter, personal details of investors, investment criteria, and features of products are all represented in frames. In order to facilitate the system solution and to reduce the search space, the products with similar features are grouped together. Even the rules are grouped together and are attached to the appropriate frames. Rules are used to guide the system selection of the investment products and are attached to various slots in the frames. Hence, the control becomes modular and local to the frames (Nedovic & Devedzic, 2002).

Another study is conducted by Zargham & Mogharreban (2005) where they developed an ES, called PORSEL (PORtfolio SElection system), which uses a small set of rules to select stocks. This ES includes three parts; first, the information center which provides representation of several technical indicators such as price trends, second, the fuzzy stock selector which evaluates the listed stocks and then assigns a mixed score to each stock and finally the portfolio constructor which generates the optimal portfolios for the selected stocks. The PORSEL also includes a user-friendly interface to change the rules during the run time. The results of the study revealed that PORSEL outperformed the market almost every year during the testing period. The authors compared their system with S&P 500 Index and concluded that the portfolios constructed by their system consistently outperform the S&P 500 Index (Bahrammirzaee, 2010). However, the performance of the system was analyzed only by means of returns. There is no information about risk level and risk adjusted returns of the portfolios constructed by PORSEL.

Recently, Xidonas & Ergazakis et. al. (2009) developed a rule-based ES for selection of the securities. The ES uses the criteria based solely on fundamental analysis techniques for making rational and non-speculative investment decisions within a long term horizon. One of the main features of the methodology is that the

firms that participate in the evaluation process are categorized in classes with respect to their corresponding industry. Each of the selected criteria was modeled using a three-point scale: very satisfactory, satisfactory and non-satisfactory. The thresholds for the financial ratios were determined by the experts, in such a way as to represent their practical implementation. After the determination of the threshold values for all the criteria sets, detailed hierarchical decision trees were constructed for each security class. Finally, a set of 1406 production rules were constructed in total. The validity of the ES was tested on the data concerning firms whose equities are traded in the Athens Stock Exchange leveraging from the opinion of experts.

In a recent work, Fasanghari & Montazer (2010) developed a fuzzy rule-based ES for portfolio recommendation. The stocks were ranked by a fuzzy rule-based ES considering a few criteria specified by experts. Each input of the system was modeled using three linguistic variables (low, medium and high) by triangular MFs. The parameters of MFs and number of production rules in knowledge base were determined by fuzzy Delphi method that integrates knowledge of multiple experts. The ES was implemented on ten stocks traded on Tehran Stock Exchange. Then, portfolios were constructed by selecting the stocks recommended by the ES that takes into account the preferences and risk profile of investors. The ES was validated by interviewing with experts and users.

As can be seen from the previous studies, stock evaluation process is highly unstructured and there is not a fix set of criteria for evaluating stocks. While some of the studies use solely fundamental criteria, others use only technical criteria. However, the ES developed in this study takes into account both fundamental and technical criteria, and there are totally 20 inputs related to these criteria. Therefore, it becomes possible to evaluate stocks in a more accurate way. In addition, as stated previously, due to the complexity of the evaluation process, and interactions or conflict between fundamental and technical criteria, a fuzzy inference system is suitable for the ES. Moreover, industrial characteristics of the stocks are taken into account in the stock evaluation stage of the ES. However, dividing the rule base into several stock evaluation rule bases for different industrial classes is burdensome.

Herein, different stock rankings obtained for each industry may be confusing in portfolio construction stage. Therefore, relative fundamental values that are obtained by dividing fundamental values of the stocks to the corresponding industrial average are used in this study. Hence, stocks can be evaluated by considering their industrial characteristics in a single rule base and a unique ranking for all stocks can be obtained. These features of the proposed ES can facilitate its understanding by decision makers, and make it more applicable to the real-life problems.

Considering the related body of knowledge, it can be stated that there is a lack of ES that combines the stock evaluation and portfolio construction stages together in a practical and realistic manner. The ES developed in this study supports decision makers in their stock evaluation as well as final portfolio construction decisions in an integrated and flexible way. Actually, the portfolio construction stage is not well structured even not appear in most of the studies related to this domain. On the other hand, the proposed ES has a portfolio construction module, where an appropriate portfolio recommendation is obtained according to the investor's risk profile, preferences and diversification requirements.

As stated previously, most of the researchers in this field validate their systems through experts' or users' opinion and there exist limited study using validation methods such as using a benchmark index or portfolio. In this thesis, the proposed ES is compared with the benchmark index XU030 in terms of return and risk. That is, validation and performance evaluation of the ES is performed in an objective manner.

CHAPTER THREE

PORTFOLIO MANAGEMENT

3.1 Modern Portfolio Theory

In the most general sense, *portfolio* is a collection of investments held by an individual or an institution. An optimal portfolio is not just a collection of individual assets that have desirable risk-return characteristics. Due to economic fundamentals influence the average returns of many assets, the risk associated with one asset's returns is generally related to the risk associated with other assets' returns. If we evaluate the prospects of each asset in isolation and ignore their interrelationships, we will likely misunderstand the risk and return prospects of the investor's total investment position—our most basic concern (Maginn, Tuttle, McLeavey & Pinto, 2007). Hence, an optimal portfolio is not a simply collection of individually good assets.

When comparing investment opportunities and combining them into portfolios, how strong their returns are “linked”, i.e., whether positive deviations in the one asset tend to come with positive or negative deviations in the other assets or whether they are independent, is an important aspect. If the assets are not perfectly positively correlated, then there will be situations where one asset's return will be above and another asset's return will be below the expectance. Hence, positive and negative deviations from the respective expected values will tend to partly offset each other. As a result, the risk of the combination of assets, the portfolio, is lower than the weighted average of the risks of the individual assets. This effect will be the more distinct the more diverse the assets are (Maringer, 2005). The main goal is to build a balanced portfolio of assets with relatively stable overall rates of return.

Harry Markowitz was the first to come up with a parametric optimization model to this problem which meanwhile has become the foundation for MPT (Maringer, 2005). In his pioneering study, he derived a formula for computing the portfolio risk.

This formula not only emphasized the importance of diversifying investments to reduce the total risk of a portfolio but also showed how to effectively diversify.

3.1.1 *Markowitz Portfolio Theory*

Formerly, investors were aware of the concept of risk, however, there was no specific measure for it. Quantification of risk was an essential necessity to be able to develop a portfolio optimization model. The basic portfolio model was developed by Harry Markowitz, who derived the expected rate of return for a portfolio of assets and an expected risk measure. Markowitz (1952) showed that the variance of the rate of return was a meaningful measure of portfolio risk under a reasonable set of assumptions, and he derived the formula for computing the variance of a portfolio. As recalled, the assumptions of the Markowitz model are explained in the previous section. According to Markowitz, under these set of assumptions, a portfolio is efficient if no other portfolio offers higher expected return with the same (or lower) risk, or lower risk with the same (or higher) expected return.

3.1.1.1 *Measurement of Return and Risk*

Expected rate of return of an individual risky asset can be obtained by computing the expected value of the probability distribution of returns. The expected rate of return for a portfolio of assets is simply the weighted average of the expected rates of return for the individual assets in the portfolio. The weights are the proportion of total value for the investment. The expected rate of return for a portfolio is calculated as follows:

$$E(R_{port}) = \sum_{i=1}^n W_i E(R_i) \quad (3.1)$$

where:

W_i = the weight of asset i in portfolio

$E(R_i)$ = the expected rate of return of asset i

As stated previously, variance of returns was used as a measure of risk by Markowitz. The variance of possible rates of return R_i , from the expected rate of return $E(R_i)$ is as follows:

$$\text{Variance}(\sigma^2) = \sum_{i=1}^n [R_i - E(R_i)]^2 P_i \quad (3.2)$$

As stated previously, the risk measure proposed by Markowitz reflects not only the volatility of the asset's returns but also how much the portfolio is diversified. The diversification measure is the covariance of the returns. Covariance is a measure of the degree to which two variables "move together" relative to their individual mean values over time.

A positive covariance between two assets means that the returns on two assets tend to move or change in the same direction. In contrast, a negative covariance means the returns tend to move in opposite directions. The magnitude of the covariance depends on the variances of the returns of individual assets, as well as on the relationship between them. For two assets, i and j , the covariance of rates of return is defined as:

$$\text{Cov}_{ij} = E\{[R_i - E(R_i)][R_j - E(R_j)]\} \quad (3.3)$$

However, covariance is affected by the variability of the two individual return series. For example, a covariance value may indicate a weak positive relationship if the two individual series are volatile but would reflect a strong positive relationship if the two series are very stable. Therefore, this covariance measure should be *standardized* by taking into consideration the variability of the two individual return series. As a result, the correlation coefficient (r_{ij}) is obtained, which can vary in the range -1 to $+1$.

$$r_{ij} = \frac{Cov_{ij}}{\sigma_i \sigma_j} \quad (3.4)$$

A correlation coefficient value of +1 indicates a perfect positive linear relationship between R_i and R_j . A value of -1 indicates a perfect negative relationship between the two return series.

3.1.1.2 The Portfolio Standard Deviation Formula

In Eq. 3.1, it is shown that the expected rate of return of the portfolio is the weighted average of the expected returns for the individual assets in the portfolio. One might assume it is possible to derive the standard deviation of the portfolio in the same manner, that is, by computing the weighted average of the standard deviations for the individual assets. This would be a mistake, because the correlation between returns of assets will be overlooked. Markowitz derived the general formula for portfolio risk known as standard deviation of a portfolio as follows:

$$\sigma_{port} = \sqrt{\sum_{i=1}^n w_i^2 \sigma_i^2 + \sum_{i=1}^n \sum_{j=1}^n w_i w_j Cov_{ij}} \quad (3.5)$$

As can be seen from Eq. 3.5, standard deviation of a portfolio is the weighted average of the individual variances plus the weighted covariances between all the assets in the portfolio. Additionally, it can be shown that, in a portfolio with a large number of securities, this formula reduces to the sum of the weighted covariances. In other words, for a portfolio with a large number of securities, total risk of the portfolio is reduced to β of the portfolio known as undiversifiable risk or market risk.

What happens to the portfolio's standard deviation when a new asset added to a portfolio? As shown by the formula, two effects can be seen: The first is the asset's

own variance of returns, and the second is the covariance between the returns of this new asset and the returns of every other asset that is already in the portfolio. The relative weight of these numerous covariances is substantially greater than the asset's unique variance; and the more assets in the portfolio the more this is true. This means that the important factor to consider when adding an asset to a portfolio that contains a number of assets is not the asset's own variance but its average covariance with all the other assets in the portfolio.

3.1.1.3 *The Efficient Frontier and Optimal Portfolio*

If we examined different two-asset combinations and derived the curves assuming all the possible weights, we would have a graph like that in Fig. 3.1. The envelope curve that contains the best of all these possible combinations is referred to as the *efficient frontier*. Specifically, the efficient frontier represents that set of portfolios that has the maximum rate of return for every given level of risk, or the minimum risk for every level of return. An example of such a frontier is shown in Fig. 3.2. As can be seen, no portfolio on the efficient frontier can dominate any other portfolio on the efficient frontier. All of the portfolios on the efficient frontier have different return and risk levels, with expected rates of return that increase with higher risk.

Every portfolio that lies on the efficient frontier has either a higher rate of return for equal risk or lower risk for an equal rate of return than some portfolio beneath the frontier. Thus, in Fig. 3.2, Portfolio A dominates Portfolio C because it has an equal rate of return but substantially less risk. Similarly, Portfolio B dominates Portfolio C because it has equal risk but a higher expected rate of return. Due to the benefits of diversification among imperfectly correlated assets, it is expected that the efficient frontier is made up of portfolios of investments rather than individual securities. Two possible exceptions arise at the end points, which represent the asset with the highest return and that asset with the lowest risk.

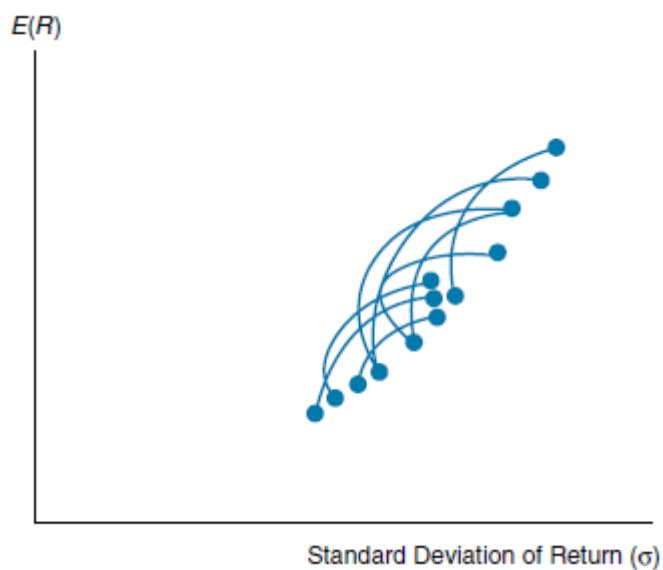

Figure 3.1 Numerous portfolio combinations of available assets (Reilly & Brown, 2004).

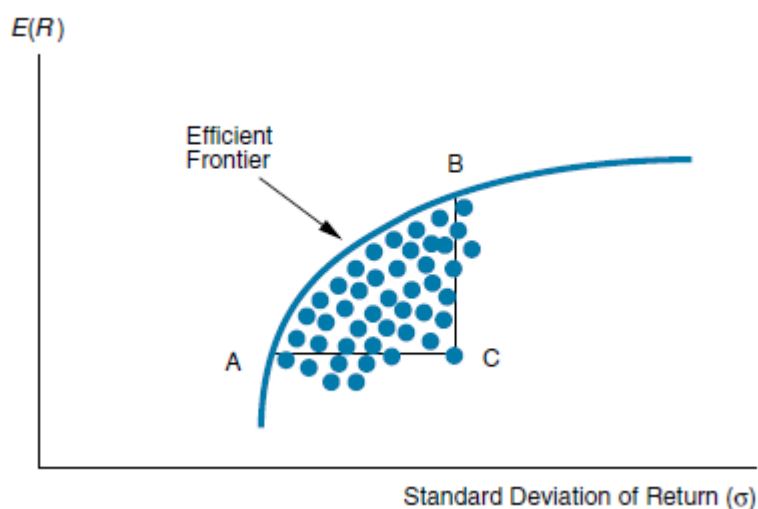

Figure 3.2 The efficient frontier for alternative portfolios (Reilly & Brown, 2004).

An individual investor's utility curves specify the trade-offs he or she is willing to make between expected return and risk. In conjunction with the efficient frontier, these utility curves determine which particular portfolio on the efficient frontier best suits an individual investor. Two investors will choose the same portfolio from the efficient set only if their utility curves are identical. Fig. 3.3 shows two sets of utility curves along with an efficient frontier of investments. The curves labeled U_1 , U_2 and U_3 are for a strongly risk-averse investor. These utility curves are quite steep,

indicating that the investor will not tolerate much additional risk to obtain additional returns. The investor is equally disposed toward any $E(R)$, σ combinations along a specific utility curve. The curves labeled U_1' , U_2' and U_3' characterize a less-risk-averse investor. Such an investor is willing to tolerate a bit more risk to get a higher expected return.

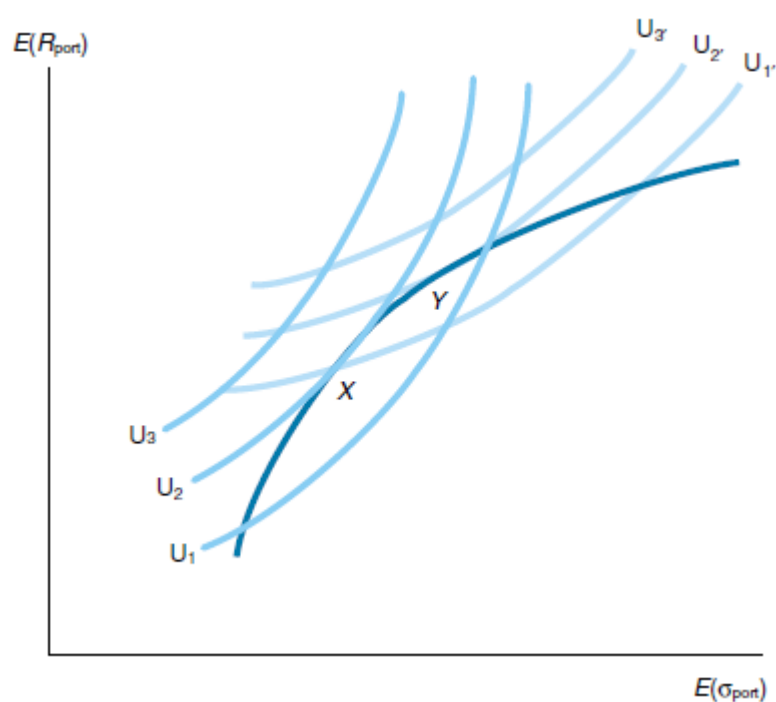

Figure 3.3 Selecting an optimal risky portfolio on the efficient frontier (Reilly & Brown, 2004).

The *optimal portfolio* is the portfolio on the efficient frontier that has the highest utility for a given investor. It lies at the point of tangency between the efficient frontier and the curve with the highest possible utility. A conservative investor's highest utility is at point X in Fig. 3.3, where the curve U_2 just touches the efficient frontier. A less-risk-averse investor's highest utility occurs at point Y , which represents a portfolio with a higher expected return and higher risk than the portfolio at X (Reilly & Brown, 2004).

3.1.1.4 Risk-Free Asset and Risk-Free Rate of Return

Following the development of Markowitz portfolio model, several authors considered the implications of assuming the existence of a *risk-free asset*. Risk-free asset has zero variance and zero correlation with other risky assets. Therefore, the expected rate of return offered by such assets is RFR which should equal the expected long-run growth rate of the economy with an adjustment for short-run liquidity. Specification of RFR is essential for investors since they compare rate of return of their risky portfolio with RFR and they demand a rate of return over RFR as a reward to taking risk.

3.1.1.5 Market Portfolio and Diversification

Market portfolio is a completely diversified portfolio that contains all risky assets. Therefore, in market portfolio, all the risk unique to individual assets that is called *unsystematic risk* is diversified away. More specifically, unsystematic risk of any single asset is offset by the unique variability of all the other assets in the portfolio.

On the other hand, β is the standard deviation of returns from the market portfolio and can change over time depending upon the changes in the macroeconomic variables that affect the valuation of all risky assets. Examples of such macroeconomic variables would be variability of growth in the money supply, interest rate and volatility.

The total risk of portfolio (β plus unsystematic risk) can be reduced by increasing the number assets in the portfolio. As can be seen in Fig. 3.4, as the number of assets increases the unsystematic risk is almost completely eliminated. However, even the all unsystematic risk is diversified away; still there will be β . In other words, we can only reduce the unsystematic risk level by diversification, cannot reduce β since it depends on variability and uncertainty of macroeconomic factors. β can only be reduced by diversifying the portfolio globally.

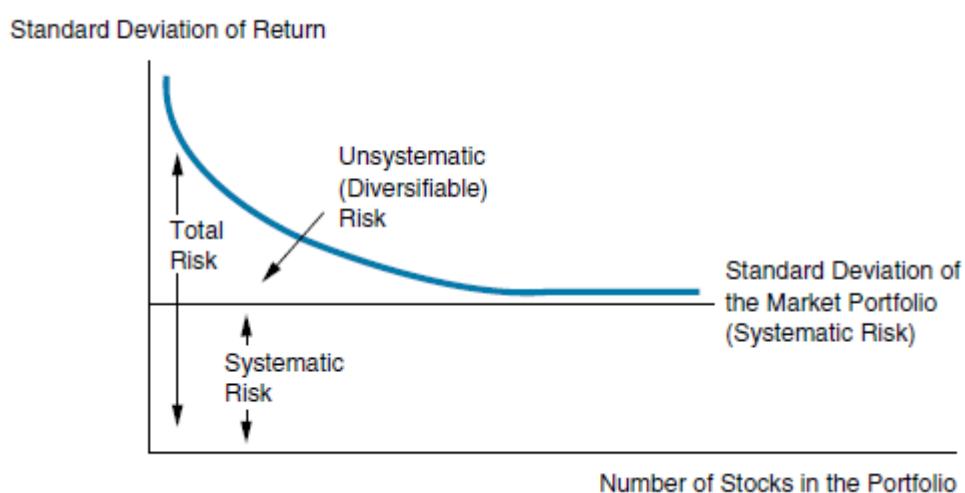

Figure 3.4 Number of assets in a portfolio and standard deviation of portfolio return (Reilly & Brown, 2004).

3.1.2 *Efficient Market Hypothesis*

An efficient capital market is one in which security prices adjust rapidly to the arrival of new information and, therefore, the current prices of securities reflect all information about the security. The essential premise of efficient market is a large number of independent participants who are analyzing and valuing assets in market. Additionally, in an efficient market, new information about assets comes to market independently and randomly. Moreover, market participants adjust the prices of assets as soon as the new information comes. Although this adjustment may be imperfect, it is unbiased. More specifically, sometimes the market will over-adjust and other times it will under-adjust, but you cannot predict which will occur at any given time. Prices of assets are adjusted rapidly due to the many participants competing against one another.

Due to security prices adjust to all new information; these security prices should reflect all information that is publicly available at any point in time. Therefore, the security prices that prevail at any time should be an unbiased reflection of all currently available information, including the risk involved in owning the security. Consequently, in an efficient market, the expected returns implicit in the current

price of the security should reflect its risk, which means that investors who buy at these efficient prices should receive a rate of return that is consistent with the perceived risk of the stock. In other terms, the efficient market theory can be seen as a fair game model, contending that investors can be confident that a current market price fully reflects all available information about a security and the expected return based upon this price is consistent with its risk (Reilly & Brown, 2004).

There are numerous studies in literature related to different facets of efficient market hypothesis (EMH). Some of these studies have supported the hypotheses and indicate that capital markets are efficient. However, results of other studies have revealed some anomalies related to this hypothesis, indicating results that do not support the hypotheses. Moreover, a new dimension has been added to the controversy because of the rapidly expanding research in behavioral finance recently.

Finally, due to the evidence that fails to support the EMH, making superior investment decisions through active security valuation and portfolio management has come into question. The two major analysis techniques, fundamental analysis and technical analysis, which are most commonly used to support superior investment decisions, will be explained in subsequent sections.

3.2 Fundamental Analysis

Fundamental analysis mainly focuses on the economic strengths and weaknesses of the market being assessed, and on the individual features of the stocks within the market (Brentani, 2004). Fundamental analysts believe that each individual stock has an intrinsic value and that is depend on tangible factors that affect its present and future actual economic performance of the stock such as its price-earnings ratio, its dividend payments, its levels of riskiness, the overall industry and market health, and so on. After looking at these factors, they can compute the intrinsic or true worth of the stock. Intrinsic value of a stock is the present value of the company's stream of future earnings and dividend payments. By holding a stock, an investor would get certain amounts of dividends from the company every year. Also, the stock price

would appreciate or depreciate depending on performance of the company. Each year a certain amount of wealth (positive or negative) would accrue to the investor. The total benefit of holding a stock is the sum of the benefits that accrue to the investor each year. If present price of the stock is lower than this intrinsic value, one must buy because sooner or later others in the market will figure out its true worth. If it is higher than the inherent value, one must sell. Fundamental analysts believe that future prices cannot be predicted by using past prices because past prices have nothing to do with a stock's true worth. They believe that future prices can be predicted only if broader indicators are taken into account (Romeu & Serajuddin, 2001).

Fundamental analysis does not contradict EMH. Fundamental analysts believe that, occasionally, market price and intrinsic value differ; however investors recognize the discrepancy and correct it eventually. Therefore, if an investor estimate intrinsic value of stock superiorly and make superior market timing decisions, he or she will get above-average returns. In order to act superiorly, one must estimate intrinsic value of stocks both correctly and differently from the consensus. If the valuation is correct but not different from the consensus, no surprising or no abnormal return will be obtained. That is, the superior analyst or successful investor must understand what variables are relevant to the valuation process and has the ability of interpreting the impact or estimating the effect of some public information better than others (Reilly & Brown, 2004). Thus, most of the investment companies have equity research divisions in which there is a group of trained professionals, for estimating intrinsic value of stocks.

Fundamental analysts use several quantitative and qualitative analysis techniques to estimate intrinsic value of stock. The most common quantitative technique used by fundamental analyst is financial statement analysis of companies. Through financial statement analysis, liquidity, profitability, marketability and financial risk can be analyzed objectively.

3.2.1 *Liquidity Analysis*

Liquidity analysis indicates the ability of company to meet future short-term financial obligations. The widely used liquidity ratios are current ratio (CR), quick ratio (QR) and cash ratio.

Current ratio indicates whether company has enough liquid resources to pay short term debts. Specifically, CR compares company's current assets to current liabilities:

$$\text{Current Ratio}(CR) = \frac{\text{Current Assets}}{\text{Current Liabilities}} \quad (3.6)$$

If CR of a company is below 1, in other words current liabilities exceed current assets, the company may have problems meeting its short-term financial obligations. On the other hand, if the CR is too high, the company may not be efficiently using its current assets.

Some observers believe that total current assets should not be considered when measuring the ability of the firm to meet current financial obligations because inventories and some other assets included in current assets might not be very liquid. As an alternative, they prefer *QR*, also known as *acid test ratio*, which relates current liabilities to only relatively liquid current assets as follows (Reilly & Brown, 2004).

$$\text{Quick Ratio}(QR) = \frac{\text{Cash} + \text{Marketable Securities} + \text{Receivables}}{\text{Current Liabilities}} \quad (3.7)$$

Additionally, *Cash ratio* is the most conservative liquidity ratio and compares company's cash and marketable securities to current liabilities:

$$\text{Cash Ratio} = \frac{\text{Cash} + \text{Marketable Securities}}{\text{Current Liabilities}} \quad (3.8)$$

There is no ideal value for liquidity ratios, since critical values for these ratios are different for each industry. Therefore, it is important to compare liquidity ratio values with similar companies or industries.

3.2.2 Profitability Analysis

Profitability of a company can be measured at several levels of its income statement. Major measures of profitability are *gross profit*, *earnings before interest and taxes* (EBIT), *earnings before taxes* (EBT) and *net profit*. Gross profit is the difference between total revenue and cost of making a product or providing a service, and indicates the basic cost structure of the company. EBIT is a measure of profit that excludes interest and tax expenses. EBT is another measure of profit that excludes tax expenses. Finally, net profit indicates the profitability of company accounting whole costs of the company.

Return on equity (ROE) is a widely used ratio to measure profitability. ROE indicates the rate of return on shareholder's equity (common equity) and calculated as follows:

$$\text{ROE} = \frac{\text{Net Income}}{\text{Common Equity}} \quad (3.9)$$

ROE is an important performance indicator for a company since it is possible to divide it into several components. This breakdown of ROE into component ratios is generally referred to as the *DuPont system*. ROE is composed of three ratios as in the following.

$$\frac{\text{Net Income}}{\text{Common Equity}} = \frac{\text{Net Income}}{\text{Net Sales}} \times \frac{\text{Net Sales}}{\text{Total Assets}} \times \frac{\text{Total Assets}}{\text{Common Equity}} \quad (3.10)$$

$$= \text{Profit Margin} \times \text{Assets Turnover} \times \text{Financial Leverage}$$

DuPont analysis enables the analyst to understand source of the return. As can be seen from Eq. 3.10, company's rate of return is mainly dependent on its profit margin, assets turnover and financial leverage. Dominance of these return components in return is different for companies in different industries.

3.2.3 Marketability Analysis

Marketability analysis relates company's internal performance to stock market performance. In marketability analysis, P/E, DY and market value to book value (MV/BV) are used commonly by investors.

P/E is used to compare the price paid for a share of a company with net income earned by the share.

$$P/E = \frac{\text{Market price of a share}}{\text{Earnings per share}} \quad (3.11)$$

A high P/E value indicates that investors are willing to pay for stock more than its return, in other words, investors overvalue the stock. In contrast, a low P/E value indicates that the stock is undervalued.

DY indicates that how much company pays out dividend relative to its stock price. DY is an important ratio for investors since they use it to measure the return on investment in the absence of any capital gains.

$$DY = \frac{\text{Annual dividend per share}}{\text{Market price per share}} \quad (3.12)$$

MV/BV indicates the relationship between company's *market value* and *book value*. *Book value* is the company's total tangible assets minus the total liabilities in its balance sheet. On the other hand, *market value* (market capitalization) is the total value of company's stocks in stock market.

$$MV/BV = \frac{\text{Market value of company}}{\text{Book value of company}} \quad (3.13)$$

A high MV/BV implies that investors expect company to create more value from its assets. However, it doesn't provide direct information about the ability of company to generate profit for its shareholders. On the other hand, MV/BV indicates whether an investor is paying too much for what would be left if the company went bankrupt immediately. As most of the fundamental ratios do, MV/BV varies from a stock to another stock by their industries (wikipedia, n.d.).

3.2.4 *Financial Risk Analysis*

The main source of financial risk of a company is its debts and the level of its *financial leverage*. Financial leverage is the ability of a company to meet its financial obligations. Financial leverage can be measured by using several fundamental ratios such as *total debt to total equity (D/E)*, *total debt to total assets (D/A)* and *leverage ratio*.

D/E compares company's total debt with its common equity and calculated as follows:

$$D/E = \frac{\textit{Total liabilities}}{\textit{Common equity}} \quad (3.14)$$

A high D/E indicates that company supports its growth mainly with debt. As a result of interest expenses due to its high level of debt, its shareholders will get more volatile, consequently more risky returns.

D/A compares company's total debt with its total assets. As in the case of D/E, D/A should be low.

$$D/A = \frac{\textit{Total liabilities}}{\textit{Total assets}} \quad (3.15)$$

Leverage ratio compares company's total assets with its common equity. Leverage ratio is calculated as follows:

$$\textit{Leverage} = \frac{\textit{Total assets}}{\textit{Common equity}} \quad (3.16)$$

Leverage ratio indicates that how much of the company's total assets are financed by common equity. This ratio reflects not only the debt structure of the company, but also the capital structure of it. Leverage ratio, like other fundamental ratios, depends on the industry in which the company operates.

As stated previously, comparing fundamental ratios of companies from different industry classes is not reasonable due to the different characteristics of them. For example, the companies having very high inventory turnover faces low *CR* values than the companies in other industries. This low *CR* value should not be seen as an indicator of poor liquidity performance and should be compared with the other company's *CR* values that operates in the same industry with the company.

By using relative ratios, fundamental analysis can be performed by taking the industrial characteristics into account. Additionally, by the use of relative ratios, stocks can be evaluated through a single procedure regardless of whether they are in the same industry or not. Considering these facts, relative fundamental ratios are used in this study. These ratios are obtained by dividing the ratio of a company to the related industry average of that ratio.

3.3 Technical Analysis

Technical analysis is the study of past price movements and changes in trading volume to predict future movements of stock prices (Romeu & Serajuddin, 2001). The philosophy behind technical analysis is in sharp contrast to EMH, which contends that past performance has no influence on future performance or market values. Technical analysts develop technical trading rules from observations of past price movements of the stock market and individual stocks. Technical analysts believe that when new information comes to the market, it is not immediately available to everyone but is typically disseminated from the informed professional to the aggressive investing public and then to the great bulk of investors. In addition, technical analysts assert that investors do not analyze information and act immediately. Moreover, they believe that market is affected by numerous rational and irrational factors that are economic variables relied on by the fundamental analysts as well as opinions, moods and guesses. Therefore, they hypothesize that stock prices move to a new equilibrium after the release of new information in a gradual manner, which causes trends in stock price movements that persist. Specifically, technical analysts do not attempt to predict the new equilibrium value. They look for the beginning of a movement from one equilibrium value to a new equilibrium value so that they can benefit from the move to the new equilibrium by buying if the trend is up or selling if the trend is down (Reilly & Brown, 2004).

Technical analysts acknowledge the effect of fundamental variables on stock prices. However, they assert that a fundamental analyst can experience superior returns only if they process the fundamental data that is available to the majority of

market superiorly. Furthermore, technical analysts point out the unreliability and incompleteness of financial statements of companies that are major inputs of fundamental analysis. They argue that no standard procedure is followed in the development of such reports. Firms can choose from a variety of procedures to furnish their revenue, expense, and return figures. Moreover, to the technical analyst, financial reports do not account for many intangible psychological factors that potentially can affect the future of an industry. Thus, they concentrate on only price and volume that encapsulate everything: investor knowledge, investor uncertainty, and investor ignorance rather than financial statements (Romeu & Serajuddin, 2001).

Assume a fundamental analyst determines that a given security is under or overvalued a long time before other investors. However, he or she still must determine when to make the purchase or sale. Ideally, the highest rate of return would come from making the transaction just before the change in market value occurs. For example, assume that based on your analysis in February, you expect a firm to report substantially higher earnings in June. Although you could buy the stock in February, you would be better off waiting until about May to buy the stock so your funds would not be tied up for an extra three months, but you may be reticent to wait that long. In contrast, due to most technicians do not invest until the move to the new equilibrium is underway, they contend that they are more likely to experience ideal timing compared to the fundamental analyst (Reilly & Brown, 2004).

In technical analysis field, none of trading rules or indicators is guaranteed to be successful but some of them are widely accepted and used by technical analysts. These technical indicators can be classified into four groups such as *moving average (MA) indicators*, *momentum indicators*, *oscillators* and *volume indicators*.

3.3.1 Moving Average Indicators

Moving average indicators are very popular among technical analyst since they smooth past price data and underline price trend. They also remove noisy data, specifically, daily price fluctuations. A MA with longer lag yields more smooth and

accurate results but it may be indifferent to short term fluctuations. In contrast, a MA with shorter lag may be too sensitive to daily fluctuations and may not reflect the main trend of price.

There are various types of MA in literature. Nevertheless, simple MA (SMA) and exponential MA (EMA) are the most commonly used MA types by technical analysts. Simple MA gives the same weight to all past prices. On the other hand, exponential MA gives higher weight to more recent prices. These two types of MA are used to develop trading rules by analysts. Trading rules generally rely on the comparison of stock price with the corresponding MA. If the price is above the MA, a buy signal is generated. In contrast, if the price is below the MA, a sell signal is generated. Furthermore, it is possible to develop more complicated trading rules based on MAs. For example, a MA with short lag (MA short) and another MA with long lag (MA long) can be compared. In this case, a buy signal will be generated when *MA short* is above the *MA long* and a sell signal will be generated *MA short* is below the *MA long*. A good example to these indicators is moving average convergence-divergence (MACD) indicator.

- MACD Indicator

As *stated* previously, MACD is based on a comparison of two MAs with different lags. Therefore, in order to obtain MACD, two MAs (MACDline and MACDsignal) have to be calculated.

$$MACDline = EMA(12) - EMA(26) \quad (3.17)$$

$$MACDsignal = EMA(9) \text{ of } MACDline \quad (3.18)$$

As can be seen from Eq. 3.17, MACDline is the difference between the 12 days and 26 days EMAs of the price. MACDsignal is obtained by calculating 9 days EMA of MACDline. Generally, MACD indicator is used as a histogram that displays the

difference between MACDline and MACDsignal. The histogram oscillates around the zero line.

By using MACD indicator, several trading rules can be developed. The most common trading rule that is used in practice is *buy* or *sell* signals which are generated when MACDline and MACDsignal cross. A *buy signal* is generated when MACDline crosses from below to above MACDsignal. On the other hand, a *sell signal* is generated when MACDline crosses above to below MACDsignal. The mechanism of these rules is visualized in Fig. 3.5. In the figure, the red line corresponds to MACDline, the blue line corresponds to MACDsignal and the dark blue line corresponds to the histogram. As can be seen, buy and sell signals are generated when MACDline and MACDsignal crosses.

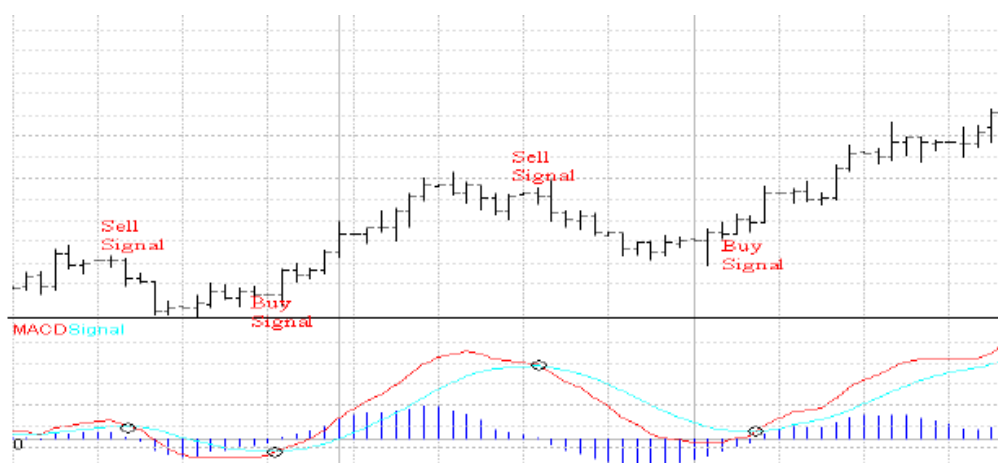

Figure 3.5 Buy and sell signals generated by MACD indicator (realtimeforex, n.d.).

Furthermore, MACD can indicate the direction of price trend. As illustrated in Fig. 3.5, there is an upward trend when both MACDline and MACDsignal are above of the zero line and there is a downward trend when both MACDline and MACDsignal are below of the zero line. Additionally, if MACD indicator diverges from price, price trend will turn to the opposite direction.

Although MA indicators are widely used by analysts to identify price trends, they can have a slow response to changes in trends, missing the beginning and end of each

move. They also tend to be unstable in sideways-moving markets; generating repeated buy and sell signals (whipsaw) leading to unprofitable trading. In addition, selecting the lag period which is sensitive enough to generate a useful early trading signal but which is insensitive to random noise is challenging. Another difficulty which can emerge in using MA indicators is that the longer the period of the MA used the greater the quantity of data required for model building and testing (Brabazon & O'Neill, 2006).

3.3.2 *Momentum Indicators*

Momentum indicators measure the speed of change in prices over a time period. Momentum is calculated by dividing the current price to the price n days ago.

$$\text{Momentum}_t = \frac{\text{Price}_t}{\text{Price}_{t-n}} \quad (3.19)$$

Generally, time period for momentum (n) is specified as 12 days by analysts. Another type of momentum indicator used by analysts is *rate of change* momentum (ROC). ROC is calculated as follows.

$$\text{ROC}_t = \frac{\text{Price}_t - \text{Price}_{t-n}}{\text{Price}_{t-n}} \quad (3.20)$$

If the momentum indicator is rising, prices will keep rising. However, it is not guaranteed that this price trend will move in the same direction. Generally, extreme momentum values are seen as a signal of a change in the direction of price trend by analysts. Fig. 3.6 visualizes generating buy and sell signals by using momentum indicator. In the figure, the red line corresponds to momentum indicator.

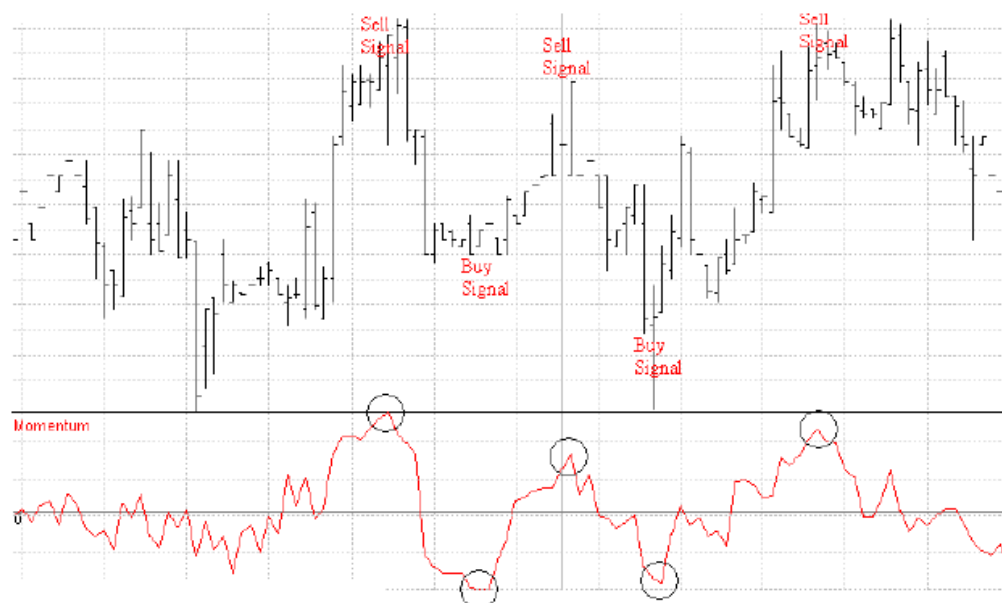

Figure 3.6 Buy and sell signals generated by momentum indicator (realtimeforex, n.d.).

Momentum indicator is more reliable when it is in the same direction with the price trend. In this case, a reduction in upward momentum indicates that an upward trend is weakening and generates a sell signal. In contrast, a buy signal is generated when the downward momentum is weakening.

3.3.3 Breakout Indicators

Breakout indicators are based on *support and resistance* concept in technical analysis. A support level is the price range at which the technician would expect a substantial increase in the demand for a stock. Technical analysts reason that, at some price below the recent peak, other investors who did not buy during the first price increase and have been waiting for a small reversal to get into the stock. When the price reaches this support price, demand surges and price and volume begin to increase again. A *resistance level* is the price range at which technical analyst would expect an increase in the supply of stock and a price reversal. A resistance level develops after a steady decline from a higher price level, that is, the decline in price

leads some investors who acquired the stock at a higher price to look for an opportunity to sell it near their breakeven points (Reilly & Brown, 2004).

There are several breakout indicators used in practice. In this section, two of these, *Commodity Channel Index* (CCI) and *Bollinger bands* (BB) are explained.

- CCI

CCI was originally developed to identify the cyclical turns of commodities. However, it is successfully used by technical analysts to predict the trend reversals of stock prices. CCI sets support and resistance levels for a stock along with the variation of its price. CCI is calculated as follows:

$$CCI_t = \frac{Price_t - SMA(14)}{0.015 \times \sigma_{price_t}} \quad (3.21)$$

CCI varies between -100 and +100. When CCI is above 100, a sell signal is generated. Conversely, when CCI is below -100, a buy signal is generated. In other words, while 100 serves as a resistance level, -100 serves as a support level. Generating buy and sell signals by using CCI is visualized in Fig. 3.7.

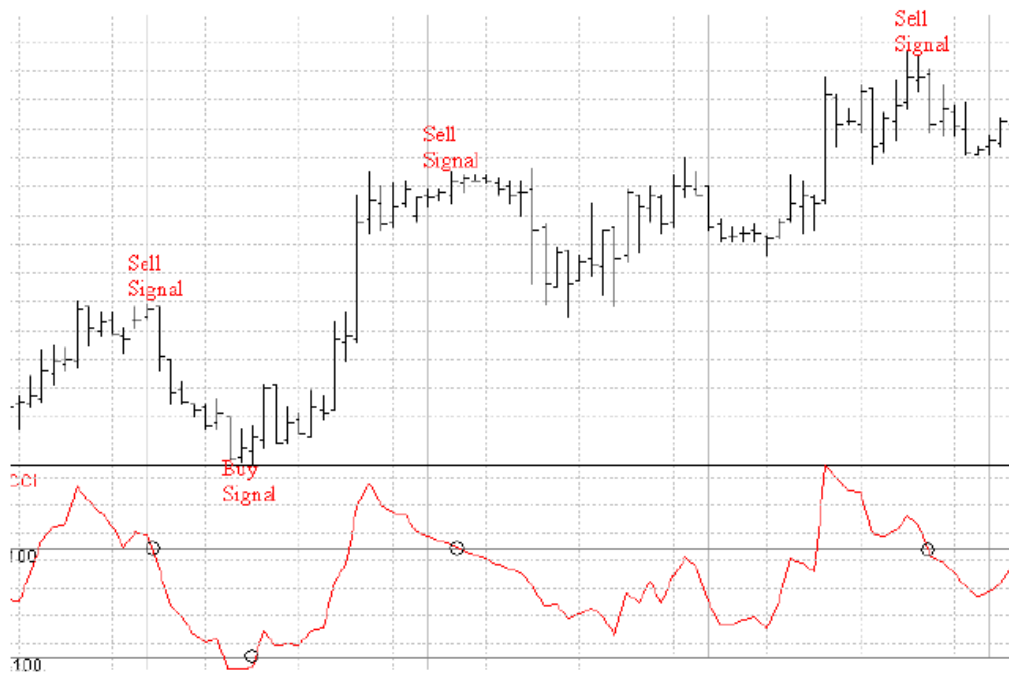

Figure 3.7 Buy and sell signals generated by CCI (realtimeforex, n.d.).

- Bollinger Bands

Bollinger bands serve as support and resistance levels and are obtained by using standard deviation of price from its MA. BBs are calculated as follows:

$$\text{Upper BB} = \text{SMA}(20) + K \times \sigma_{\text{price}} \quad (3.22)$$

$$\text{Middle BB} = \text{SMA}(20) \quad (3.23)$$

$$\text{Lower BB} = \text{SMA}(20) - K \times \sigma_{\text{price}} \quad (3.24)$$

Middle BB is a 20 days SMA of price, upper and lower BBs are as far as K times standard deviation of price from its SMA. Generally, K is specified as 2 in practice. When the price is below of lower BB, it means that the stock is oversold and a buy signal can be generated. Conversely, when the price is above of the upper BB, the

stock is overbought and its price may decline soon. Therefore, in this case, a sell signal can be generated. An example to this way of thinking is illustrated in Fig. 3.8.

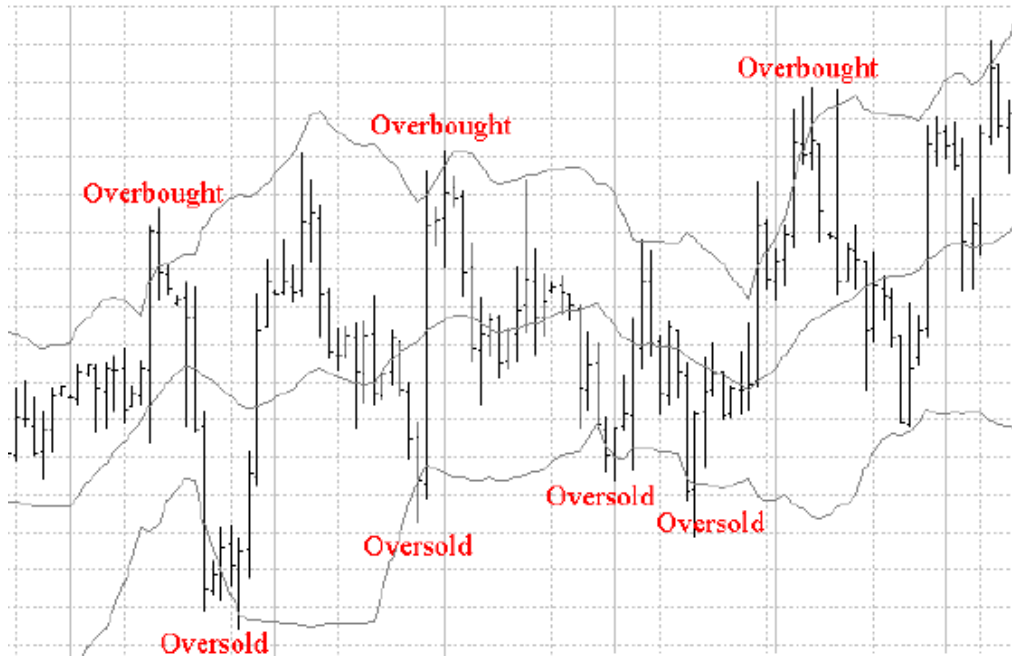

Figure 3.8 Overbought and oversold signals generated by BBs (realtimeforex, n.d.)

By using BBs, two technical indicators are developed; %B and bandwidth. %B indicator measures the distance of price from lower BB relative to the bandwidth at that moment. %B is calculated as follows:

$$\%B_t = 100 \times \frac{Price_t - Lower\ BB}{Upper\ BB - Lower\ BB} \quad (3.25)$$

On the other hand, *bandwidth* is used to predict the possible price movements in the future. Bandwidth measures the distance between lower and upper BBs normalized by the middle BB as follows:

$$Bandwidth_t = \frac{Upper\ BB - Lower\ BB}{Middle\ BB} \quad (3.26)$$

As can be seen from Fig. 3.9, a wide bandwidth indicates that the stock price is volatile. Conversely, a narrow bandwidth indicates that the stock price is less volatile. Furthermore, bandwidth tightens before a sharp volatility in price.

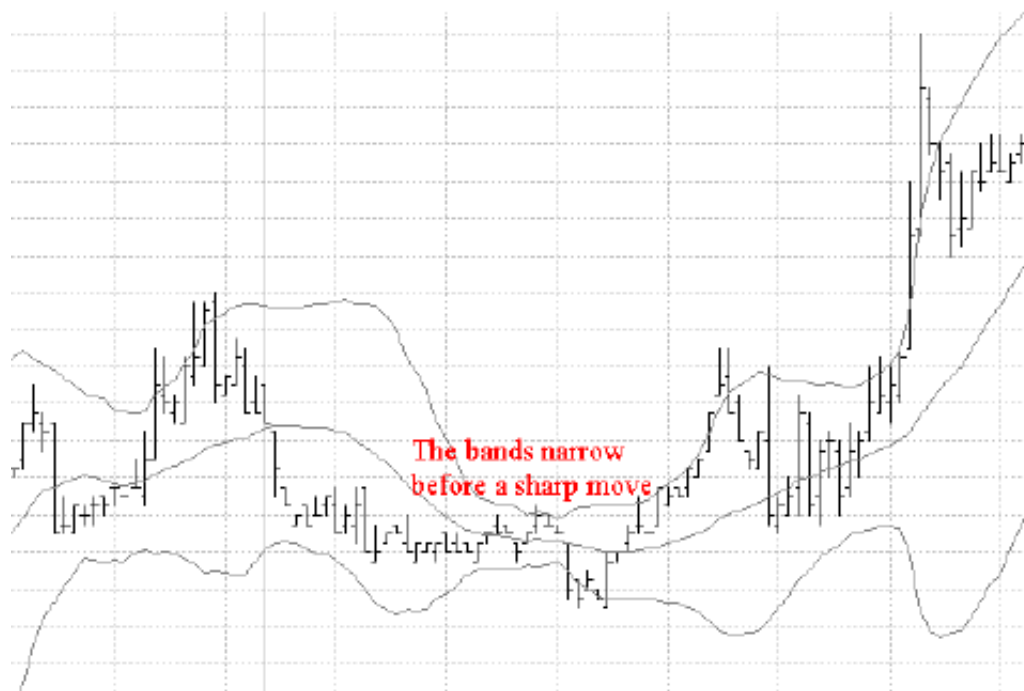

Figure 3.9 The effect of a change in bandwidth (realtimeforex, n.d.).

3.3.4 Oscillators

Oscillators are used to determine when the market is overbought or oversold. Generally, they compress price data into a fixed range, typically 0-100. Hence, they are called oscillators as they can only vary between an upper and lower bound (Brabazon & O'Neill, 2006). In this section, stochastic oscillator and relative strength index (RSI) that are the oscillators widely used in practice are explained in detail.

- Stochastic Oscillator

Stochastic oscillator is used to predict the price turns comparing the price with its range. Stochastic indicator consists of two lines: %K and %D. %K and %D are calculated as follows:

$$\%K_t = 100 \times \frac{Price_t - L(14)}{H(14) - L(14)} \quad (3.27)$$

where $L(14)$ is the lowest price over 14 days period and $H(14)$ is the highest price over this period.

$$\%D_t = SMA(3) \text{ of } \%K \quad (3.28)$$

When %K and %D move above 80, the stock is considered to be overbought. Therefore, a sell signal is generated. Conversely, when they move below 20, a buy signal is generated. Additionally, crossing of two lines triggers buy or sell signal. If %K and %D cross and then %K moves upwards, a buy signal is generated. In contrast, if %K and %D cross and then %K moves downwards, a sell signal is generated. These buy or sell signals are illustrated in Fig. 3.10. In the figure, the red line corresponds to %K and the blue line corresponds to %D.

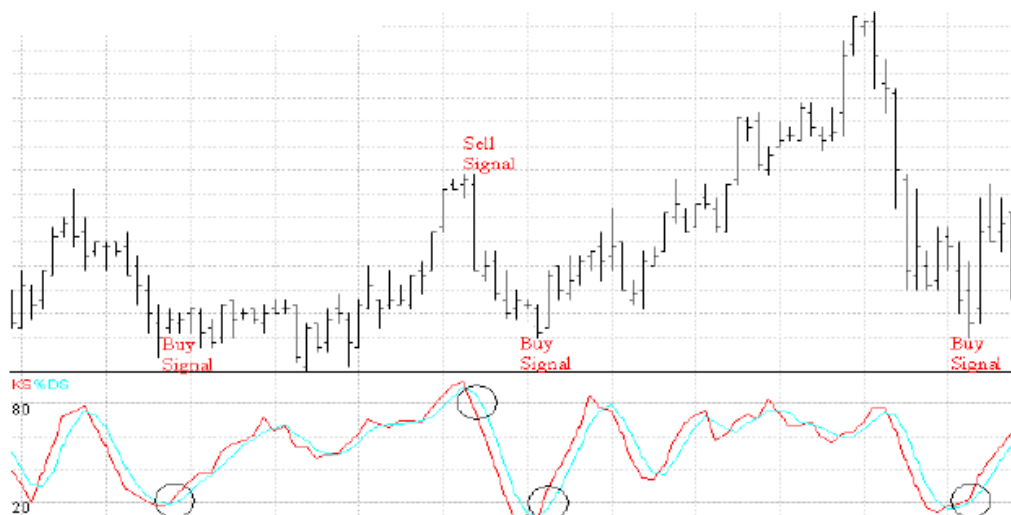

Figure 3.10 Buy and sell signals generated by stochastic oscillator (realtimeforex, n.d.).

Stochastic oscillators tend to work best in sideways or non-trending markets, and tend to identify small price reversals in relatively flat markets. In strongly trending markets, they are less useful and can become stuck at extreme values at either end of their range while the trend persists (Brabazon & O'Neill, 2006).

- *RSI*

RSI measures the internal strength of a stock price movement. Relative strength (RS) of a stock compares its recent gains with its recent losses and is calculated as follows:

$$RS = \frac{EMA(14) \text{ of up closes}}{EMA(14) \text{ of down closes}} \quad (3.29)$$

After calculating RS, RSI indicator which varies between -100 and 100 can be calculated:

$$RSI = 100 - \frac{100}{1 + RS} \quad (3.30)$$

If RSI is above 70, it is expected the market to form a top, then RSI crossing back below 70 can be used as a sell signal. The same is true for market bottoms, if RSI moves back above 30, a sell signal is generated. Examples to these signals are illustrated in Fig. 3.11. However, these signals are best used in non-trending markets. In trending markets, the signals in the same direction of the trend are reliable. For example, if there is an upward trend, it is more reliable taking only buy signals (realtimeforex, n.d.).



Figure 3.11 Buy and sell signals generated by RSI (realtimeforex, n.d.).

3.3.5 Volume Indicators

The same market dynamics that give rise to price, also give rise to trading volume. Technical analysts believe that changes in volume can act as a lead indicator of coming price changes. Price and volume information can be combined to obtain a measure of market strength. A market is considered strong by technical analysts if both price and volume are rising (Brabazon & O'Neill, 2006). Hence, technical analysts developed several indicators that relate price changes to volume. In this section, one of these indicators, *on balance volume* (OBV) is explained in detail.

- OBV

OBV provides a cumulative total volume that represents whether the volume is flowing in or the volume is flowing out. OBV indicator is calculated by adding volume on up-closed days and subtracting volume on down- closed days.

$$OBV_t = \begin{cases} OBV_{t-1} - Volume_t, & \text{if } Price_t \leq Price_{t-1} \\ OBV_{t-1}, & \text{if } Price_t = Price_{t-1} \\ OBV_{t-1} + Volume_t, & \text{if } Price_t \geq Price_{t-1} \end{cases} \quad (3.31)$$

A rising OBV reflects positive volume pressure that can lead to higher prices. Conversely, falling OBV reflects negative volume pressure that can foreshadow lower prices. The absolute value of OBV is not important for analysts. Instead, they focus on the characteristics of the OBV line (stockcharts, n.d.). Several trading rules can be developed that are depended on the characteristics of OBV. An example to them is comparing OBV indicator with its SMA. According to this technical rule, a buy signal is generated when the OBV line crosses the SMA line and move upwards. Conversely, a sell signal is generated when the OBV line crosses the SMA line and move downwards.

Despite of the advantages of technical analysis, there are some criticisms on them. The majority of the criticism is on the assumptions of technical analysis. One of these assumptions is that it is possible to predict future price trends by analyzing the price movements in the past. However, the past price patterns may not be repeated. Thus, trading rules are not guaranteed to be successful. For this reason, most of technical analysts use several trading rules and seek a consensus of these rules in their buy or sell decisions.

Another criticism on technical analysis is that the success of a particular trading rule has to be its downfall. Suppose that a particular trading rule is said to be successful. Naturally more and more people would adopt it in the hope of profiting from it. This would quickly cause the profits from such a rule to disappear. As stated

previously, the rationale behind technical analysis is that since prices adjust slowly, there are ample arbitrage opportunities in the market. More people using a specific trading rule would cause rapid price adjustments, undoing such arbitrage opportunities (Romeu & Serajuddin, 2001).

As stated previously, both technical and fundamental analyses have advantages and disadvantages. Fundamental analysis seems to be more appropriate for long term investments. However, it provides no information about short term fluctuations in stock prices and overshoots market behavior of stock. On the other hand, technical analysis seems to be more appropriate for short term investments, specifically for trading. It gives comprehensive information about trends and daily price fluctuations, but it is not guaranteed that current price behavior will continue. Furthermore, most of the portfolio managers assert that technical analysis is mistaken about speculative stocks and they frequently examine financial statements of the companies that are suggested by technical analysis. Considering these facts, in this study, we used both technical and fundamental measures to support portfolio managers in their stock evaluation and portfolio construction decisions.

3.4 Portfolio Performance Evaluation

There are two major requirements from a portfolio manager. The first one is the ability of deriving above-average returns for a given risk class. The second one is the ability of diversifying the portfolio completely to eliminate all unsystematic risk, relative to the portfolio's benchmark (Reilly & Brown, 2004). Investment skill of a portfolio manager is defined as the ability to outperform an appropriate benchmark consistently over time. Specifically, a manager's returns in excess of his or her benchmark are commonly referred to as the manager's *value-added return* or *active return*. However, every manager's value-added returns, regardless of the manager's skill, will be positive in some periods and negative in others. Nevertheless, a skillful manager should produce a larger value-added return more frequently than his or her less talented peers (Maginn et. al., 2007).

However, it is not a proper idea to regard the rate of return as a unique measure of portfolio performance. It is known that minimizing the risk of portfolio is crucial, since it affects volatility of returns. Moreover, thanks to the development MPT, risk became quantifiable and consequently, can be used as a portfolio performance measure. Nevertheless, measuring return and risk, and using them as performance measures separately is not enough for an accurate portfolio performance evaluation. Therefore, researchers developed composite portfolio performance measures that measure portfolio returns on risk-adjust basis, such as *Treynor ratio*, *Sharpe ratio*, *Jensen's alpha* and *information ratio (IR)*. We use these measures in this study to compare the performances of the portfolios.

3.4.1 *Treynor Ratio*

The first composite portfolio performance measure was developed by Treynor. He proposed two components of risk; risk produced by general market fluctuations (β) and risk resulting from unique fluctuations (unsystematic risk) in the portfolio of stocks (Reilly & Brown, 2004). As explained previously, in a completely diversified portfolio, unsystematic risk is eliminated and consequently, total risk of the portfolio reduces to its β . However, Treynor was not concerned on diversification concept and his performance measure is based on β coefficient:

$$Treynor = \frac{\bar{R}_i - \overline{RFR}}{\beta_i} \quad (3.32)$$

Here, \bar{R}_i is the average rate of return of portfolio i during the specified investment period. \overline{RFR} is the average RFR during the same period. β_i is β of portfolio i . Treynor ratio indicates the risk premium of a portfolio per unit of β .

Since Treynor ratio assumes the portfolio is completely diversified and β is a relevant measure for portfolio risk, it is preferred by investors who have highly diversified portfolios. They compare their portfolio's Treynor ratio with Treynor

ratio of overall market. A higher Treynor ratio than Treynor ratio of the market indicates a superior risk-adjusted performance.

3.4.2 *Sharpe Ratio*

Sharpe ratio measures portfolio's excess return per unit of total risk (β plus unsystematic risk). This ratio is calculated as follows:

$$Sharpe = \frac{\bar{R}_i - \overline{RFR}}{\sigma_i} \quad (3.33)$$

As can be seen from Eq. 3.33, Sharpe ratio is similar to Treynor ratio. However, denominator of Sharpe ratio is portfolio's total risk (σ_i), whereas Treynor ratio only regards β of portfolio. Therefore, Sharpe ratio measures both excess rate of return and diversification performance of a portfolio. Since the total risk is reduced to β for a completely diversified portfolio, Sharpe and Treynor ratios will be equal for such portfolio. On the other hand, for a poorly diversified portfolio, Treynor ratio may be high, but Sharpe ratio will be low. Specifically, any difference between Sharpe and Treynor ratio occur because of the diversification performance.

3.4.3 *Jensen's Alpha*

Jensen's alpha indicates portfolio's excess return that predicted by CAPM based on the β of the portfolio and the average market return. From the CAPM given in Eq. 2.5, a linear regression model can be developed for rate of return:

$$R_{jt} = RFR_t + \beta_j (R_{Mt} - RFR_t) + e_{jt} \quad (3.34)$$

Here, ε_{jt} is the random error term of the regression. Subtracting RFR_t from both sides of the equation we have:

$$R_{jt} - RFR_t = \beta_j [R_{mt} - RFR_t] + e_{jt} \quad (3.35)$$

The resulting equation yields the risk premium obtained by portfolio. In this form, an intercept for the regression is not expected if all assets and portfolios were in equilibrium. Alternatively, superior portfolio managers who forecast market turns or consistently select undervalued securities earn higher risk premiums than those implied by this model. Specifically, superior portfolio managers have consistently positive random error terms because the actual returns for their portfolios consistently exceed the expected returns implied by this model. In order to detect and measure this superior performance, an intercept (a nonzero constant) that measures any positive or negative difference from the model must be allowed. Consistent positive differences cause a positive intercept, whereas consistent negative differences (inferior performance) cause a negative intercept. As a result, the earlier equation becomes:

$$R_{jt} - RFR_t = \alpha_j + \beta_j [R_{mt} - RFR_t] + e_{jt} \quad (3.36)$$

where, α_j is the intercept of the regression. This term indicates whether the portfolio manager is superior or inferior in market timing and/or stock selection. A superior manager has a significant positive α value because of the consistent positive residuals. In contrast, an inferior manager's returns consistently fall short of expectations based on the CAPM model giving consistently negative residuals. In such a case, α is a significant negative value. Therefore, α represents how much of the rate of return on the portfolio is attributable to the manager's ability to derive above-average returns adjusted for risk (Reilly & Brown, 2004).

3.4.4 Information Ratio

Information Ratio compares portfolio's rate of return with a benchmark portfolio's rate of return on a risk-adjusted basis. This ratio is calculated as follows:

$$IR = \frac{\bar{R}_j - \bar{R}_b}{\sigma_{ER}} = \frac{\overline{ER}_j}{\sigma_{ER}} \quad (3.37)$$

Here, \bar{R}_b is the average return of benchmark portfolio. Benchmark portfolio is often specified by analysts as an index such as Standard & Poor's 500 index (SP500). The numerator of the ratio is often referred to as the *active return* on the portfolio that represents the investor's ability to generate an excess portfolio return with respect to the benchmark portfolio's return. On the other hand, denominator is the standard deviation of active return that is called *tracking error* of portfolio and seen as the cost of active portfolio management.

CHAPTER FOUR

EXPERT SYSTEMS

Expert system is a computer program that simulates the thought process of a human expert to solve complex decision problems in a specific domain (Badiru & Cheung, 2002). ESs were developed as research tools in 1960s as a special type of AI to successfully deal with complex problems in a narrow domain such as medical disease diagnosis. Later on, ESs have greatly increased in popularity since their commercial introduction in 1980s. Today ESs are used in business, science, engineering, manufacturing and many other fields (Giarratano & Riley, 2005).

Expert systems make extensive use of specialized knowledge to solve problems at the level of human expert. An expert is a person who has *expertise* in a certain area. Specifically, the expert has knowledge or special skills that are not known or available to most of people. Therefore, the expert can solve problems that other people cannot solve or solve problems much more efficiently than other people (Giarratano & Riley, 2005). However, human expertise is not always available and is perishable. In contrast, ES can be operated any time in a day like other machines. In addition, it can be cheaply duplicated and distributed to locations in which there is a lack of an expert. Moreover, it can be operated in dangerous environments in which human cannot work. Furthermore, performance and speed of an expert can vary because of fatigue and physiological factors. Conversely, a well designed ES has consistent speed and reliable performance all the time.

The main objectives in developing an ES are replacing expert or assisting expert. The aim of the ES developed in this study is assisting the expert. It is the most common application of ES. In this application, the ES aids the expert in a routine or mundane task. Additionally, information that is difficult to recall can be made available to the expert by using ES. Moreover, these systems can aid the expert in some difficult task to effectively manage the complexities. For example, a physician may have knowledge of most diseases, but, due to extensive number of diseases,

could benefit from the support provided by an ES to quickly isolate the disease (Durkin, 1994).

4.1 ES Application Domains

Expert systems can be applied to vast amount of domains such as control, design, diagnosis, instruction, interpretation, monitoring, planning, prediction, selection, simulation (Durkin, 1994; Turban & Aronson, 2001). These application domains are explained in the following.

Control

Control systems adaptively govern the behavior of a given system. Controlling a manufacturing process and treatment of a patient in a hospital are the examples of control systems. An expert control system obtains data on the system's operation and interprets them to form an understanding of the system's state or a prediction of its future state adaptively. Control systems must also perform monitoring and interpretation tasks to track system behavior over time.

Design

Design systems develop configurations of objects that satisfy constraints of design problem. Such problems include circuit layout, building design and plant layout. Design systems construct descriptions of objects in various relationships between each other and verify that these configurations conform to stated constraints.

Diagnosis

Diagnosis systems infer system malfunctions or faults from observable information. Most diagnosis systems have knowledge of possible fault conditions with means to infer whether the fault exists from information on the system behavior. Most diagnosis systems include a prescription task that offers a remedy to the

detected fault. Diagnosing a given disease from the patient's symptoms and locating malfunctions in an electronic circuit from test results are examples of these systems.

Instruction

Instruction systems guide education of a student in a given topic. They treat the student as a system that must be diagnosed and repaired. Typically, they begin by interacting with the student to form a model of student's understanding of the topic. Then, they compare this student model with an ideal model to uncover weaknesses in the student's understanding. This task then followed by remedial instruction to correct any misunderstandings.

Interpretation

Interpretation systems produce an understanding of a situation from available information. Typically, this information consists of data from such sources as sensors, instruments, test results, etc. Machine monitoring systems, imaging systems and speech analysis systems are examples of these. These systems often have to work with noisy, incomplete or unreliable data that requires inexact or statistical reasoning.

Monitoring

Monitoring systems compare observations of system behavior with standards that seem crucial for successful goal attainment. These crucial features correspond to potential flaws in the plan. There are many computer-aided monitoring systems for topics ranging from air traffic control to financial management tasks.

Planning

Planning systems form actions to achieve a given goal under a set of constraints. They deal with short and long term planning in areas such as project management,

routing communications and financial planning. Some planning systems must have flexibility to change the series of planned tasks when they obtain new problem information. Therefore, they need ability to backtrack and reject a current line of reasoning in favor of exploring a better one.

Prediction

Prediction systems infer likely consequences from a given situation. These systems attempt to predict future events using available information and a model of the problem. Prediction systems are often able to reason about time or ordered events. Moreover, they must be available to infer how some given action influences future events. Some application areas of prediction systems are weather forecasting, traffic prediction, crop estimate, marketing and financial forecasting.

Selection

Selection systems identify the best choice from a list of alternatives. They work from problem specifications defined by user and attempt to find a solution that most closely matches these specifications. These systems usually employ an inexact reasoning technique or a matching evaluation function when forming their selections.

Simulation

Simulation systems model a process or system to permit operational studies under various conditions. They model various components of system and their interactions. Users are usually permitted to make adjustments to the model in order to account for either existing or hypothetical conditions. Additionally, using the model along with the user-supplied information, these systems can be used to predict operating conditions for the real system.

4.2 Appropriate Problem Structures for ES

Before developing an ES, it is essential to decide if ES is appropriate solution technique to the problem under concern. The problems that are computational or deterministic in nature are not good candidates for ESs. Traditional decision support systems such as spreadsheets are very mechanistic in the way they solve problems. They operate under mathematical and Boolean operators in their execution and arrive at one and only one static solution for a given set of data. Therefore, calculation-intensive applications with very exacting requirements are better handled by traditional decision support tools or conventional programming. Furthermore, conventional computer programs are based on factual knowledge, an indisputable strength of computers. Human, in contrast, solve problems on the basis of a mixture of factual and heuristic knowledge. Heuristic knowledge, composed of intuition, judgment, and logical inferences, is an indisputable strength of human. Successful ESs will be those that combine facts and heuristics and thus merge human knowledge with computer power in solving problems (Badiru & Cheung, 2002).

Specifically, ES is best suited for *ill-structured problems*. Ill-structured problems are those that have uncertainties associated with it. For an ill-structured problem, goals are not explicit, problem space is unbounded, problem states are not discrete and state operators are unknown. An ill-structured problem would not lend itself well to an algorithmic solution because there are so many possibilities (Giarratano & Riley, 2005).

Furthermore, it is very important to have well defined limitations on what the ES is expected to know and what its capabilities should be. For example, suppose you wanted to create an ES to diagnose headaches. Certainly, medical knowledge of physician would be put in the knowledge base. Moreover, for a deep understanding of headaches, you might also put in knowledge about neurochemistry, then its parent area of biochemistry, then chemistry, molecular biophysics and so forth. However, the more domains, the more complex the ES becomes (Giarratano & Riley, 2005). Therefore, the problem should be limited to a sufficiently narrow scope.

4.3 ES Structure

Complex decisions involve intricate combination of factual and heuristic knowledge. In order to be able to retrieve and effectively use heuristic knowledge, the knowledge must be organized in an easily accessible format that distinguishes among data, knowledge, and control structures (Badiru & Cheung, 2002). Therefore, as illustrated in Fig. 4.1, ESs consist of distinct but interactive components. Functions of these components are explained in the following (Durkin, 1994; Turban & Aronson, 2001).

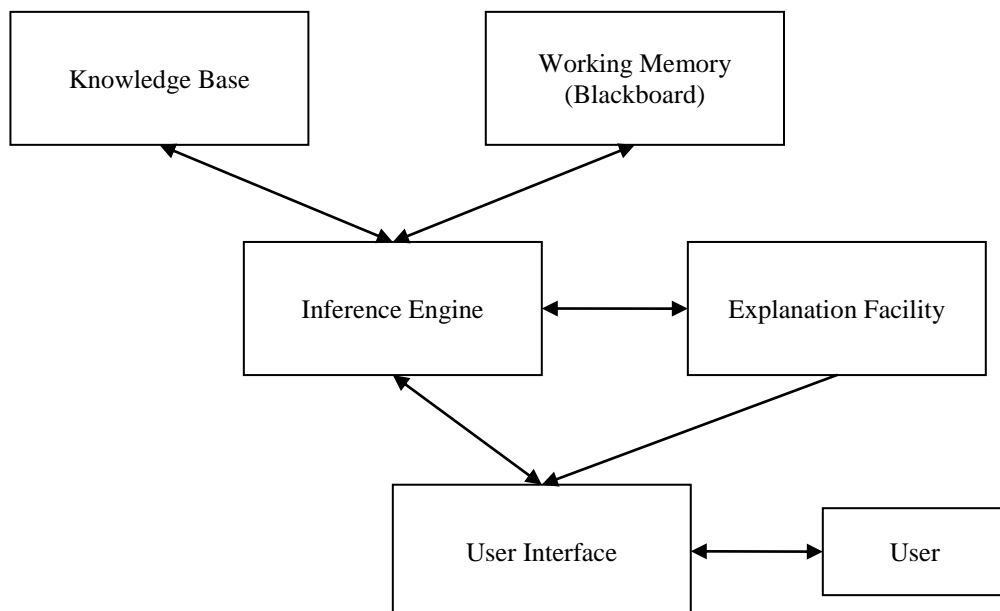

Figure 4.1 The basic structure of an ES.

Knowledge base contains domain expert knowledge that is necessary for understanding, formulating and solving problems. It includes two basic elements: facts such as problem situation and theory of the problem area, and special heuristics or rules that direct the use of knowledge to solve specific problems in a particular domain (In addition, inference engine can include general purpose problem solving

and decision making rules). Specifically, heuristics express the informal judgmental knowledge in an application domain.

Working memory of an ES is usually called *blackboard* by practitioners. It is an area set aside as a database for description of a current problem as specified by input data and it is also used for recording intermediate hypothesis and decisions. Specifically, user enters information on a current problem into the working memory. The system matches this information with the knowledge to infer new facts. Then, the system enters these facts into the working memory and the matching process continues. Eventually, the system reaches some conclusion that it also enters into working memory.

Inference engine is the brain of an ES and models the process of human reasoning. Inference engine is a computer program that provides a methodology for reasoning about domain knowledge contained in knowledge base and facts contained in the working memory. It searches the rules in knowledge base for a match between their premises and information contained in working memory. When it finds a match, it adds conclusion of the rule to working memory and continues to scan the rules for new matches.

The ability to trace responsibility for conclusions to their sources is crucial both in transfer of expertise and in problem solving. Thus, *explanation facility* of an ES can provide an explanation to the user about why a certain question was asked by the ES or how a certain conclusion was reached. In a simple ES, explanation facility shows the rules that were used to derive the specific recommendations.

ES usually contains a *user interface* for user-friendly, problem oriented communication between the user and itself. This communication can be best carried out in a natural language. Sometimes, the interface is supplemented by menus, electronic forms and graphics.

4.4 Knowledge Acquisition

Performance of an ES on a given problem is directly related to the quality of knowledge that the system has (Durkin, 1994). Thus, *knowledge acquisition* is one of the key elements in development of an ES. Knowledge acquisition is the process by which knowledge engineers acquire and encode the knowledge that domain experts use to solve a given problem. Domain knowledge can be acquired from several sources; such as direct consultation with experts, printed materials (books, journals etc.), direct task observation and third-party accounts of expert procedures. Among them, printed materials such as handbooks, magazines, journals, and printed guides can form the basis for an initial knowledge base. Then the initial knowledge base may be expanded with the aid of one or more experts. On the other hand, of all the available sources of knowledge, direct consultation with experts poses the greatest difficulty but offers the highest level of reliability (Badiru & Cheung, 2002).

Domain expert is a key player in the knowledge acquisition process. On the other hand, knowledge engineer elicits knowledge from expert, refines it with the expert, and represents it in the knowledge base (Turban & Aronson, 2001). There are several knowledge elicitation techniques used by knowledge engineers. Some of these techniques are introduced in this section.

4.4.1 Interviews

The most commonly used form of knowledge acquisition is face to face interviews with domain expert. In the interview, the expert is presented with a simulated case or with an actual problem. Then, the expert is asked to talk the knowledge engineer through solution. Sometimes, this method is called walkthrough method. Generally, interviewing technique is quietly explicit and appears in several variations. There are two basic types of interviews; unstructured (informal) interviews and structured interviews (Turban & Aronson, 2001).

Unstructured Interviews

Many knowledge acquisition interviews are conducted informally, usually as a starting point. Starting informally saves time and helps to move quickly to the basic structure of the domain. However, unstructured interviews seldom provide complete or well organized descriptions of cognitive processes, for the following reasons: The domains are generally complex. Therefore experts usually find it difficult to express some of the more important elements of their knowledge. Moreover, domain experts may interpret the lack of structure as requiring little preparation on their part. Furthermore, data acquired from an unstructured interview are often unrelated, exist at varying levels of complexity and are difficult for the knowledge engineer to review, interpret and integrate (McGraw & Harbison-Briggs, 1989; Turban & Aronson, 2001).

Structured Interview

Structured interview is a systematic goal-oriented process and provides an organized communication between knowledge engineer and expert. This technique reduces the interpretation problems inherent in unstructured interviews and it allows the knowledge engineer to prevent the distortion caused by the subjectivity of the domain expert. Structuring an interview requires a number of procedural issues such as (McGraw & Harbison-Briggs, 1989; Turban & Aronson, 2001):

- The knowledge engineer studies available material on the domain to identify major demarcations of the relevant knowledge.
- The knowledge engineer reviews the planned ES capabilities and identifies targets for the questions to be asked during the knowledge acquisition session.
- The knowledge engineer formally schedules and plans the structured interviews.

- The knowledge engineer ensures that the domain expert understands the purpose and goals of the session and encourages the expert to prepare before the interview.
- During the interview, the knowledge engineer uses directional control to retain the interview's structure.

It is recommended that in the preliminary stage of the knowledge acquisition, an unstructured interview may be used first to obtain a large amount of general information. Later, a structured interview can be used to gain specific information about one particular aspect of the expert's technique (Badiru & Cheung, 2002). In the knowledge acquisition stage of this study, both structured and unstructured interview techniques are used.

In conclusion, interview techniques place great demands on the domain expert. Therefore, they should be planned carefully and the interview results should be subjected to thorough verification and validation methodologies (Turban & Aronson, 2001).

4.4.2 Task Performance Observations

Observing an expert performing a familiar problem-solving task can be a very productive way to gather detailed knowledge. In the case of early data gathering, the task may be simple or routine. This gives the knowledge engineer the framework of the expert's thought process. The expert must be encouraged to think aloud while performing the task. Care must be taken, however, not to interrupt this thought process except for reminders to keep to the subject matter. The knowledge engineer may also ask the expert to repeat the task, adding detailed comments as the process continues. In this method of knowledge acquisition, the study of the expert's actions is sometimes called *protocol analysis* (Badiru & Cheung, 2002).

4.4.3 Questionnaires

Questionnaires and surveys are other methods of knowledge acquisition. *Open-ended questionnaires* ask the expert to describe the methods and reasoning used to solve a problem. This may be useful in the knowledge discovery stage to provide broad information. The disadvantage of this approach is that the knowledge engineer is not present to moderate the expert and make sure the responses are really relevant to the questions. An alternative is to use a *short-answer questionnaire* format to elicit the opinion of multiple experts quickly and easily. The information that can be gathered with this method is usually limited to simple descriptions or techniques. The knowledge engineer should be sufficiently educated in the domain in order to create meaningful questions to be useful for short-answer questionnaires. On the other hand, *forced-answer questionnaires* can be used as a knowledge base-validation tool. These questionnaires call for “yes” or “no” or multiple-choice answers. For example, forced-answer questionnaires may be used to validate a production rule by asking whether the “if” clause really yields the “then” clause (Badiru & Cheung, 2002).

4.5 Knowledge Representation

Once information is acquired, it must be organized in an applications knowledge base for later use. A knowledge base can be managed like a database. It can be organized in several different configurations to facilitate a fast inference from the knowledge (Turban & Aronson, 2001). There are several techniques to organize knowledge in a knowledge base. Each technique is capable of capturing different types of knowledge efficiently. Therefore, choosing a correct technique that is appropriate to the problem is crucial for an effective problem solving. In the following section, major knowledge representation techniques, namely, semantic networks, frames, predicate logic and production rules, are described.

4.5.1 Semantic Networks

Semantic networks are one of the earliest knowledge representation techniques. They represent knowledge using a graph made up nodes and arcs where the nodes represent objects and the arcs represent relationships between the objects. Both the nodes and the arcs have labels that clearly describe the objects and their relationships (Durkin, 1994). An example to semantic networks is illustrated in Fig. 4.2.

One of the most interesting and useful facts about semantic networks is that it can show inheritance. Due to semantic network is basically a hierarchy, the various characteristics of some nodes actually inherit the characteristics of others (Turban & Aronson, 2001). This fact of semantic networks simplifies the task of coding the knowledge. For example, if there is a need to add a specific object to a semantic network, it inherits information throughout the network.

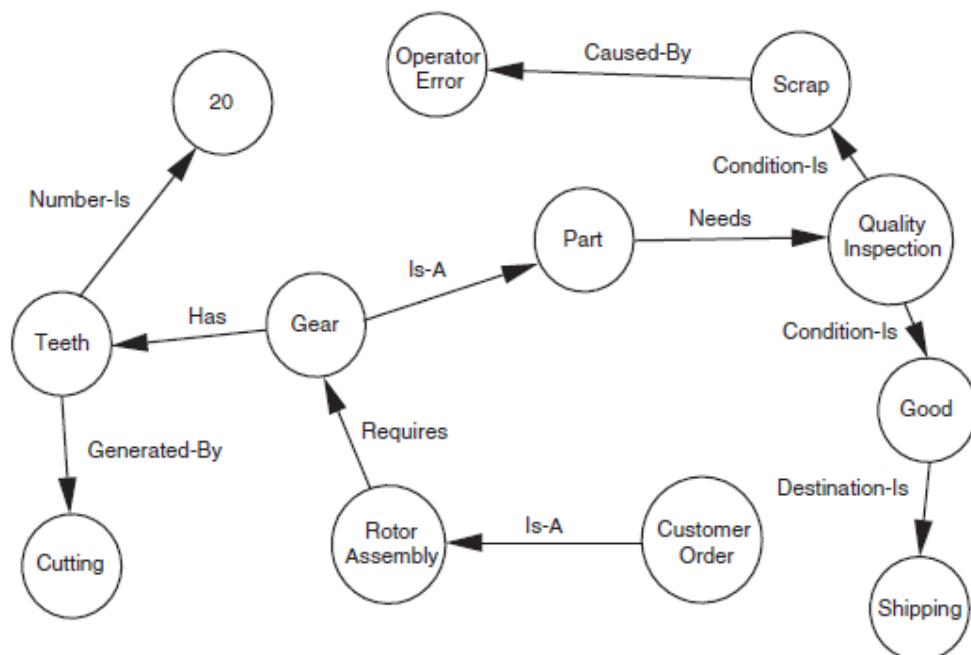

Figure 4.2 An example of semantic network (Badiru & Cheung, 2002).

4.5.2 *Frames*

Frame is a data structure that includes all the knowledge about an object. They provide a concise structural representation of knowledge in a natural manner. In contrast to the other representation methods, the values that describe one object are grouped together into a single unit called a frame. Thus, a frame encompasses complex objects, entire situations, or a management problem as a single entity (Turban & Aronson, 2001).

Frames provide a convenient structure for representing objects that are typical to a given situation. In particular, they are useful for simulating commonsense knowledge which is a very difficult area for computers to master. While semantic networks are basically two dimensional representation of knowledge, frames add a third dimension by allowing nodes to have structures. These structures can be simple values or other frames (Giarratano & Riley, 2005).

4.5.3 *Predicate Logic*

Propositional calculus is an elementary system of formal logic that is used to determine whether a given proposition is true or false. Predicate calculus adds the capability of specifying relationships and making generalizations about propositions. Logical expressions use predicate calculus to generate inferences by asserting the truthfulness or otherwise of propositional statements. Adding functions and other analytical features to predicate calculus creates first-order predicate calculus. A function is a logical construct that yields a value (Badiru & Cheung, 2002). For example, the proposition “Ball is red.” can be represented by predicate calculus as color (ball, red). Briefly, this representation technique allows the use of functions and variables in knowledge processing.

Predicate logic is best used in domains of concise and unified theories such as physics, chemistry, and other mathematical or theoretical fields. However, it is not

suitable to representation of procedural and heuristic knowledge. In addition, it has limited data manipulation procedures and has difficulty in managing large databases (Badiru & Cheung, 2002).

4.5.4 *Production Rules*

Production rule is a knowledge structure that relates some known information to the other information that can be concluded or inferred to be known. It associates given information to some action. This action may be assertion of new information or some procedure to perform. In this sense, a production rule describes how to solve a problem (Durkin, 1994).

The structure of a production rule is the form of premise-conclusion pairs. A production rule has one or more premises (antecedents) contained in the IF part and has one or more conclusions (consequents) contained in the THEN part. Multiple premises or conclusions in a production rule can be joined with a conjunction (AND) or disjunction (OR). The following is an example for such rules:

IF the credit rating is high AND the salary is more than \$75,000 OR assets are more than \$30,000 THEN approve the loan AND list the loan in category B (Turban & Aronson, 2001).

There are two major types of production rules; *declarative rules* and *procedural rules*. *Declarative rules* (knowledge rules) state all the facts and relationships about a problem. On the other hand, *procedural rules* (inference rules) advise on how to solve a problem given that certain facts are known. These rules are also called meta-rules since they pertain to other rules. For example, knowledge rules of an ES that supports the decision of buying or selling gold may look like following (Turban & Aronson, 2001):

- RULE 1: IF an international conflict begins THEN the price of gold goes up.

- RULE 2: IF the inflation rate declines THEN the price of gold goes down.
- RULE 3: IF the international conflict lasts more than seven days AND it is in the Middle East THEN buy gold.

On the other hand, the procedural rules of this ES may look like following:

- RULE 1: IF the data needed are not in the system THEN request them from the user.
- RULE 2: IF more than one rule applies THEN deactivate any rules that add no new data.

In a rule-based ES, domain knowledge is captured in a set of rules and entered in the knowledge base of the system. The system uses these rules along with information contained in the working memory to solve a problem. When the IF part of a rule matches the information contained in the working memory, the system performs the action specified in the THEN part of the rule. When this occurs, the rule is *fired* and its THEN statements are added to the working memory. The new statements added to the working memory can also cause other rules to be fired. This process is managed by inference engine that will be explained subsequently (Durkin, 1994).

Production rules can be viewed, in some sense, as a simulation of cognitive behavior of human experts. According to this view, rules are not just a neat formalism to represent the knowledge in a computer; rather, they represent a model of actual human behavior. Additionally, rules are easy to understand and are communicable since they are a natural form of knowledge. Moreover, modifications and maintenance of rules are relatively easy. Furthermore, uncertainty is easily combined with rules by using fuzzy sets and fuzzy logic (Turban & Aronson, 2001). Due to these advantages of production rules, they are utilized in the ES proposed in this study.

4.6 Inference Techniques

Once knowledge representation in the knowledge base is completed, or is at least at a sufficiently high level of accuracy, the knowledge is ready to be used. Then, a computer program is needed to access the knowledge for making inferences. This program is an algorithm that controls an inference process and is called *inference engine*. Inference engine decides which rule to investigate, which alternative to eliminate, and which attribute to match (Turban & Aronson, 2001). It combines facts contained in working memory with knowledge contained in the knowledge base and is able to infer new information. Then, it adds the new information to the working memory.

There are several inference techniques in ES domain. The major inference techniques for rule-based ES are forward chaining, backward chaining and approximate reasoning.

4.6.1 Forward Chaining

Forward chaining is an inference technique that begins with a set of known facts, derives new facts using rules whose premises match the known facts, and continues this process until no further rules have premises that match the known or derived facts. The simplest application of forward chaining proceeds as follows: The system first obtains problem information from the user and places it in the working memory. Then the inference engine scans the rules in some predefined sequence looking for one whose premises match the contents in the working memory. If it finds a rule, it adds the rule's conclusion to the working memory (in other words, fire the rule), then cycles and checks the rules again looking for new matches. On the new cycle, the rules that previously fired are ignored. This process continues until no matches are found (Durkin, 1994).

Forward chaining is called *bottom-up reasoning*, because it reasons from the low-level evidence, facts, to the top level conclusions that are based on the facts. In forward chaining systems, antecedents determine the search direction; hence the inference direction is from antecedent to consequent. Since forward chaining is a data-driven technique, it best suits to planning, monitoring and control problems (Giarratano & Riley, 2005).

4.6.2 *Backward Chaining*

Backward chaining is an inference technique that attempts to prove a hypothesis by gathering supporting information. A backward chaining system begins with a goal to prove. It first checks the working memory to see if the goal has been previously added. This step is necessary since another knowledge base may have already proven the goal. If the goal has not been previously proven, the system searches its rules for one (or more) that contain the goal in its THEN part. This type of rule is called a *goal rule*. Then, the system checks to see if the goal rule's premises are listed in the working memory. Afterwards, the premises not listed in the working memory (*subgoals*) become new goals to prove that may be supported by other rules. This process continues in this recursive manner, until the system finds a premise that is not supported by any rule (a primitive). When a primitive is found, the system asks the user for information about it. The system uses this information to help prove both the subgoals and the original goal (Durkin, 1994).

Backward chaining is called *top-down reasoning*, since it reasons from higher-level constructs, hypotheses, down to the lower-level facts that may support the hypotheses. In backward chaining systems, consequents determine the search direction; hence the inference direction is from consequent to antecedent. Since backward chaining is a goal-driven technique and similar to the hypothesis testing process in human problem solving; it best suits to diagnosis, prescription and debugging problems (Giarratano & Riley, 2005).

4.7 Approximate Reasoning

Experts often rely on common sense to solve problems. This type of knowledge exposed when expert describes a problem using vague or ambiguous terms. Human generally have little difficulty with interpreting the use of the vague terms. However, providing a computer with same understanding is a challenge (Durkin, 1994). Development of fuzzy logic has provided a convenient way to represent vague terms to computers.

Fuzzy logic is a superset of conventional (Boolean) logic that has been extended to handle the concept of partial truth, the truth values between “completely true” and “completely false”. Fuzzy logic provides a precise approach for dealing with uncertainty which grows out of the complexity of human behavior (Giarratano & Riley, 2005). In the following section, fuzzy sets, fuzzification, linguistic variables and fuzzy inference are described.

4.7.1 Fuzzy Sets

In crisp set theory, the transition for an element in the universe between membership and non-membership in a given set is abrupt and well-defined (said to be “crisp”). For an element in a universe that contains fuzzy sets, this transition can be gradual. This transition among various degrees of membership can be thought of as conforming to the fact that the boundaries of the fuzzy sets are vague and ambiguous. Hence, membership of an element from the universe in this set is measured by a function that attempts to describe vagueness and ambiguity (Ross, 2004).

In fuzzy sets, each elements is mapped to $[0,1]$ by a MF. An example to MFs is illustrated in Fig. 4.3. In this example, we consider statement "Jenny is young". Herein, the term "young" is vague. To represent the meaning of "vague" exactly, it would be necessary to define its MF as in Fig. 4.3. The horizontal axis shows age

and the vertical axis means the numerical value of MF. The line shows possibility (value of MF) of being contained in the fuzzy set "young". Now, we can manipulate our last sentence to "Jenny is very young". In order to be included in the set of "very young", the age should be lowered and let us think the line is moved leftward as in the figure. If we define fuzzy set as such, only the person who is under forty years old can be included in the set of "very young". Now the possibility of 27 year-old man to be included in this set is 0.5 (Lee, 2005).

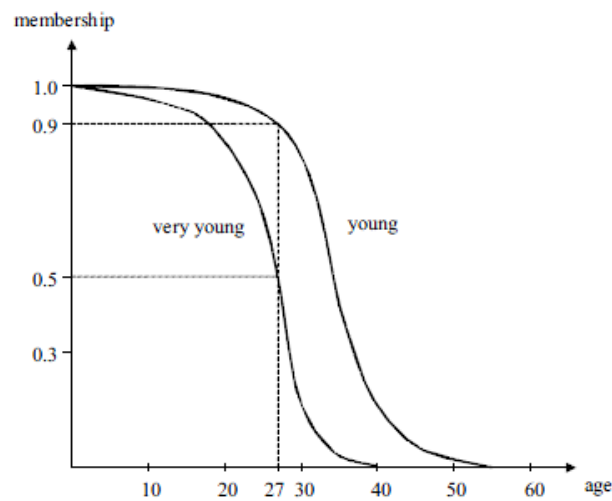

Figure 4.3 MFs for fuzzy sets "young" and "very young" (Lee, 2005).

If we denote $A = \text{"young"}$ and $B = \text{"very young"}$, membership values of a 27 year-old man to fuzzy sets A and B are $\mu_A(27) = 0.9$, $\mu_B(27) = 0.5$.

MFs of fuzzy sets can be defined by using various types of parameterized functions such as triangular, trapezoidal, Gaussian and bell-shape functions. Among these, triangular MF is the most commonly used type of MF in fuzzy systems. A triangular MF is specified by three parameters $\{a, b, c\}$ as follows:

$$\text{triangle}(x; a, b, c) = \begin{cases} 0, & x \leq a \\ \frac{x-a}{b-a}, & a \leq x \leq b \\ \frac{c-x}{c-b}, & b \leq x \leq c \\ 0, & x \geq c \end{cases} \quad (4.1)$$

An example to triangular MF is illustrated in Fig. 4.4. In this study, triangular MF is used for the inputs and outputs since it is a convenient form to parameterize the fuzziness and easy to understand for users.

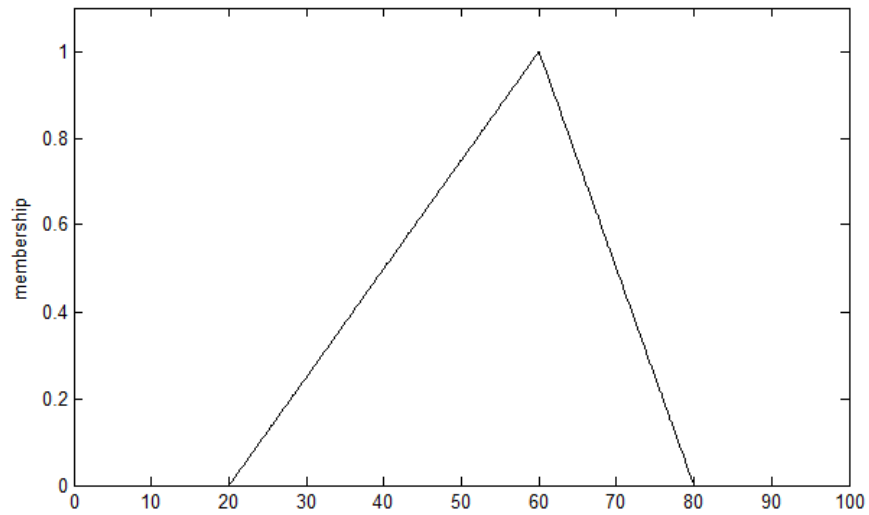

Figure 4.4 Triangular MF.

A trapezoidal MF is specified by four parameters $\{a, b, c, d\}$ as follows:

$$\text{trapezoid}(x; a, b, c, d) = \begin{cases} 0, & x \leq a \\ \frac{x-a}{b-a}, & a \leq x \leq b \\ 1, & b \leq x \leq c \\ \frac{d-x}{d-c}, & c \leq x \leq d \\ 0, & x \geq d \end{cases} \quad (4.2)$$

An example to trapezoidal MF is illustrated in Fig. 4.5.

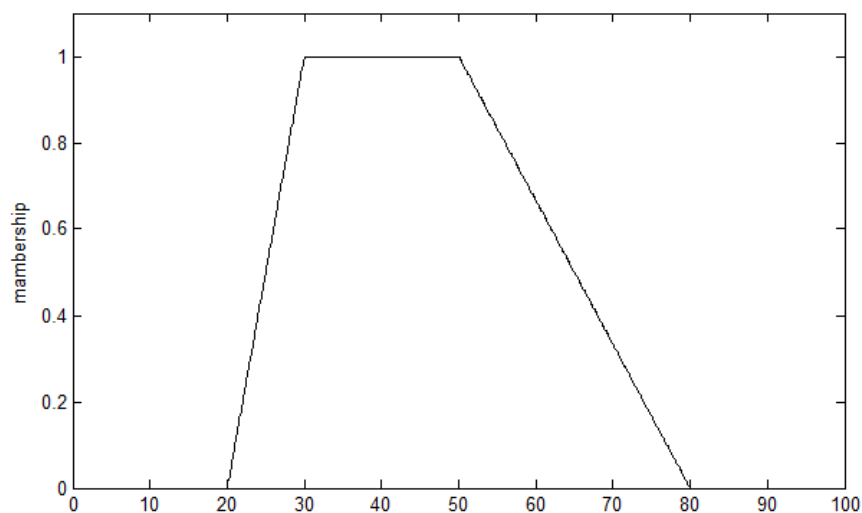

Figure 4.5 Trapezoidal MF.

A Gaussian MF is specified by two parameters $\{c, \sigma\}$ as follows:

$$gaussian(x; c, \sigma) = \exp\left(-\frac{1}{2}\left(\frac{x-c}{\sigma}\right)^2\right) \quad (4.3)$$

An example to Gaussian MF is presented graphically in Fig. 4.6.

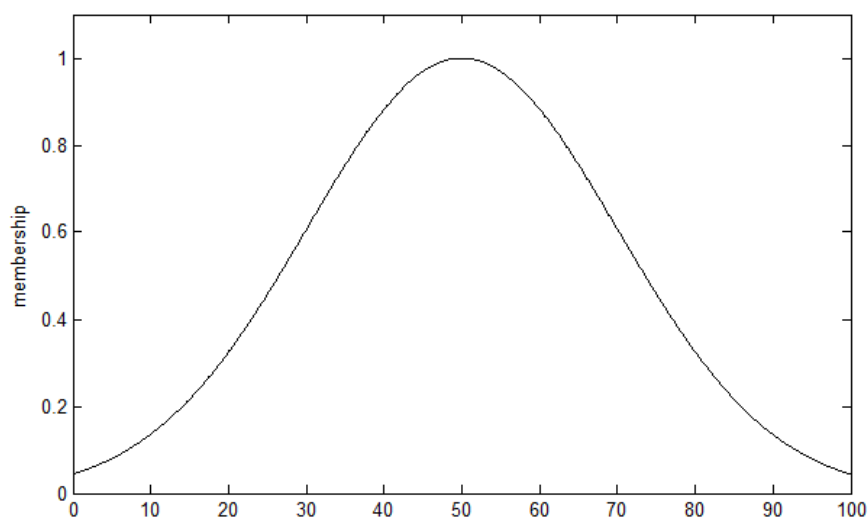

Figure 4.6 Gaussian MF.

Finally, a bell MF is specified by three parameters:

$$\text{bell}(x; a, b, c) = \frac{1}{1 + \left| \frac{x - c}{a} \right|^{2b}} \quad (4.4)$$

An example to bell MF is illustrated in Fig. 4.7.

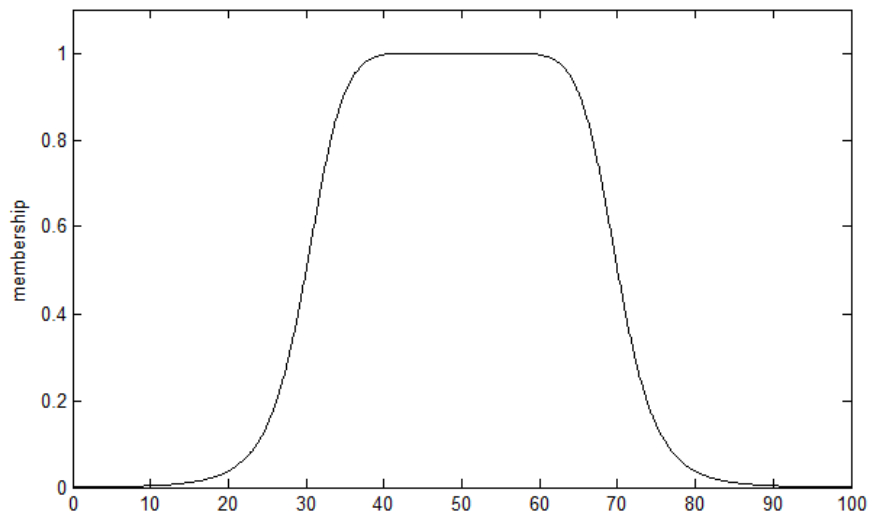

Figure 4.7 Bell MF.

4.7.2 *Fuzzification*

Fuzzification is the process of making a crisp quantity fuzzy. We do this by simply recognizing that many of the quantities that we consider to be crisp and deterministic are actually not deterministic at all: They carry considerable uncertainty. If the form of uncertainty happens to arise because of imprecision, ambiguity, or vagueness, then the variable is probably fuzzy and can be represented by a MF. For example, in the real world, hardware such as a digital voltmeter generates crisp data, but these data are subject to experimental error. The information shown in Fig. 4.8 shows one possible range of errors for a typical voltage reading and the associated MF that might represent such imprecision (Ross, 2004).

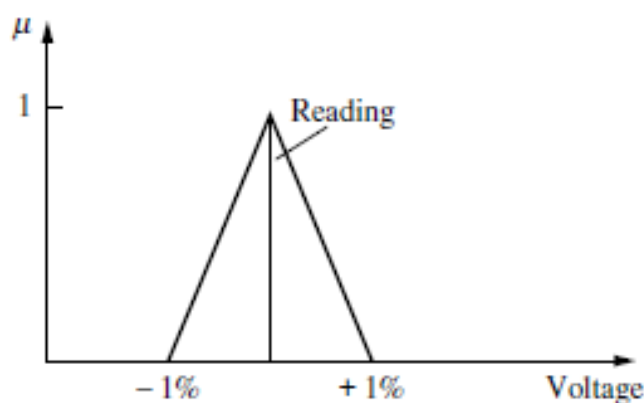

Figure 4.8 MF representing imprecision in “crisp voltage reading” (Ross, 2004).

If the process is inherently quantitative or the inputs are derived from sensor measurements, then these crisp numerical inputs could be fuzzified in order for them to be used in a fuzzy inference system. If the system to be controlled is not hardware based, e.g., the control of an economic system or the control of an ecosystem subjected to a toxic chemical, then the inputs could be scalar quantities arising from statistical sampling, or other derived numerical quantities. Again, for utility in fuzzy systems, these scalar quantities could first be fuzzified, i.e., translated into a MF, and then used to form the input structure necessary for a fuzzy system (Ross, 2004).

4.7.3 Linguistic Variables

A linguistic variable is defined by a quintuple $(x, T(x), X, G, M)$ in which x is the name of variable, $T(x)$ is the set of linguistic terms which can be a value of the variable, X is the universe of discourse, G is a syntactic rule which generates the terms in $T(x)$, and M is a semantic rule which associates each linguistic value A with its meaning $M(A)$, where $M(A)$ denotes a fuzzy set in X . For example, if “age” is interpreted as a linguistic variable, then its term set could be as follows:

$$T(\text{age}) = \{\text{young}, \text{not young}, \text{very young}, \text{not very young}, \dots, \text{not very old}\}$$

where each term $T(age)$ is characterized by a fuzzy set of a universe of discourse $X=[0,100]$. The syntactic rule refers to the way the linguistic values in the term set $T(age)$ are generated. The semantic rule defines the MF of each linguistic value of the term set (Jang, Sun & Mizutani, 1997).

From the preceding example, it can be seen that the term set consists of several *primary terms* (“young”, “old”) modified by *negation* (“not”) and/or *hedges* (very, more or less, extremely, and so forth) and then linked by *connectives* such as “and”, “or”, “either”, and “neither”. These are the operators that change the meaning of their operands in a specified, context independent fashion (Jang, Sun & Mizutani, 1997).

Let A be linguistic value characterized by a fuzzy set with MF μ_A . Concentration operator (“very”) has an effect of further reducing on membership value. Concentration operation is defined as follows:

$$\mu_{CON(A)} = (\mu_A(x))^2 \quad (4.5)$$

On the other hand, dilation operator (“more or less”) increases the membership values. Dilation operation is defined as follows:

$$\mu_{DIL(A)} = (\mu_A(x))^{0.5} \quad (4.6)$$

Furthermore, the negation operator NOT and the connectives AND and OR can be interpreted referring fuzzy logic as follows:

$$NOT A = 1 - \mu_A(x) \quad (4.7)$$

$$\begin{aligned} A \text{ AND } B &= \mu_A(x) \cap \mu_B(x) = \mu_A(x) \wedge \mu_B(x) \\ &= \min(\mu_A(x), \mu_B(x)) \end{aligned} \quad (4.8)$$

$$\begin{aligned} A \text{ OR } B &= \mu_A(x) \cup \mu_B(x) = \mu_A(x) \vee \mu_B(x) \\ &= \max(\mu_A(x), \mu_B(x)) \end{aligned} \quad (4.9)$$

where A and B are two linguistic values whose meanings are defined by μ_A and μ_B .

4.7.4 Fuzzy Inference

Fuzzy inference is the process of making logical inferences based on a given set of *fuzzy rules* and a set of inputs corresponding to the variables on the IF side of the rules. As a knowledge representation technique, fuzzy rules define the mapping of input variables with precise or imprecise values to output variables with precise values. An example to fuzzy rules is as follows (Turban & Aronson, 2001):

IF system size is large AND complexity is high, THEN effort-required is very high.

In this rule, input variables are “system size” and “complexity, output variable is “effort-required”. The linguistic variables “large” and “high” are defined using MFs to capture imprecision.

A fuzzy inference system can take either fuzzy inputs or crisp inputs but the outputs it produces are generally fuzzy sets. Sometimes it is necessary to have a crisp output, especially in a situation where a fuzzy inference system is used as a controller. Therefore, a defuzzification method is needed to extract a crisp value that best represents a fuzzy set (Jang, et. al., 1997).

In the following section, three fuzzy inference techniques that have been widely employed in various applications are introduced. These are Mamdani, Takagi-Sugeno (TSK) and Tsukamoto techniques. The differences between these techniques lie in the consequents of their fuzzy rules, and thus their aggregation and defuzzification procedures differ accordingly (Jang et al., 1997).

4.7.4.1 Mamdani Inference Technique

Mamdani inference technique is the most commonly used technique in practice. In this study, Mamdani inference technique is employed in stock evaluation stage. Mamdani systems generally use max-min inference technique. In order to illustrate Mamdani inference process, we consider a simple two-rule system where each rule comprises two antecedents and one consequent. A fuzzy system with non-interactive inputs x_1 and x_2 (antecedents) and a single output y (consequent) is described by a collection of r linguistic IF–THEN propositions as follows (Ross, 2004):

$$IF\ x_1\ is\ A_1^k\ AND\ x_2\ is\ A_2^k\ THEN\ y^k\ is\ B^k,\ for\ k = 1, 2, \dots, r.$$

where A_1^k and A_2^k are the fuzzy sets representing the k th antecedent pairs, and B^k is the fuzzy set representing the k th consequent.

Based on the Mamdani max-min inference method, the aggregated output for r rules is calculated as follows:

$$\mu_{B^k}(y) = \max_k [\min [\mu_{A_1^k}(input(i)), \mu_{A_2^k}(input(i))]] \quad k = 1, 2, \dots, r. \quad (4.10)$$

A graphical interpretation of Mamdani max-min inference technique is illustrated in Fig. 4.9. Here, A_{11} and A_{22} refer to the first and second fuzzy antecedents of the first rule, respectively, and B_1 refers to the fuzzy consequent of the first rule. A_{21} and A_{22} refer to the first and second fuzzy antecedents, respectively, of the second rule, and B_2 refers to the fuzzy consequent of the second rule. The minimum function in Eq. 4.10 is illustrated in Fig. 4.9 and arises because the antecedent pairs given in the general rule structure for this system are connected by a logical “and” connective. The minimum membership value for the antecedents propagates through to the consequent and truncates the MF for the consequent of each rule. This graphical inference is done for each rule. Then, the truncated MFs for each rule are aggregated by the aggregation operation max that results in an aggregated MF comprised of the

outer envelope of the individual truncated membership forms from each rule. If one wishes to find a crisp value for the aggregated output, some appropriate defuzzification technique could be employed to the aggregated MF, and a value such as y^* shown in Fig. 4.9 would result (Ross, 2004).

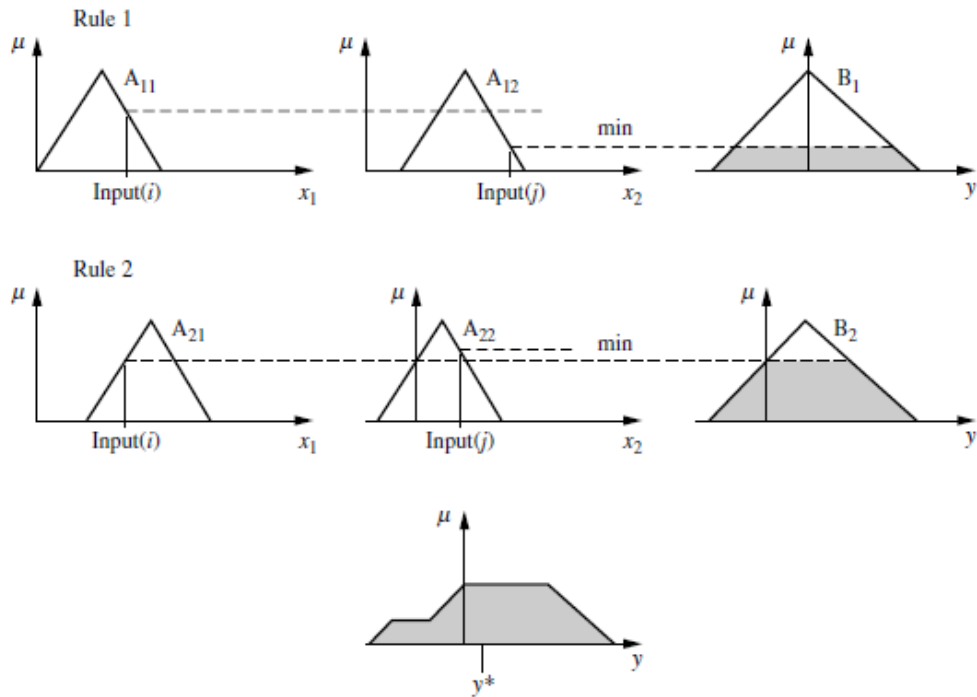

Figure 4.9 Mamdani (max-min) inference technique (Ross, 2004).

Another type of Mamdani inference technique is max-product inference. Based on the Mamdani max-product inference method, the aggregated output for r rules is calculated as follows (Ross, 2004):

$$\mu_{B^k}(y) = \max_k [\mu_{A_1^k}(\text{input}(i)) \times \mu_{A_2^k}(\text{input}(i))] \quad k = 1, 2, \dots, r. \quad (4.11)$$

A graphical interpretation of Mamdani max-product inference technique is illustrated in Fig. 4.10. As seen from the figure, in Mamdani max-product inference, the consequent MF remains as scaled triangles instead of truncated triangles in max-min inference. Again, the defuzzified value, y^* , results from some appropriate defuzzification technique (Ross, 2004).

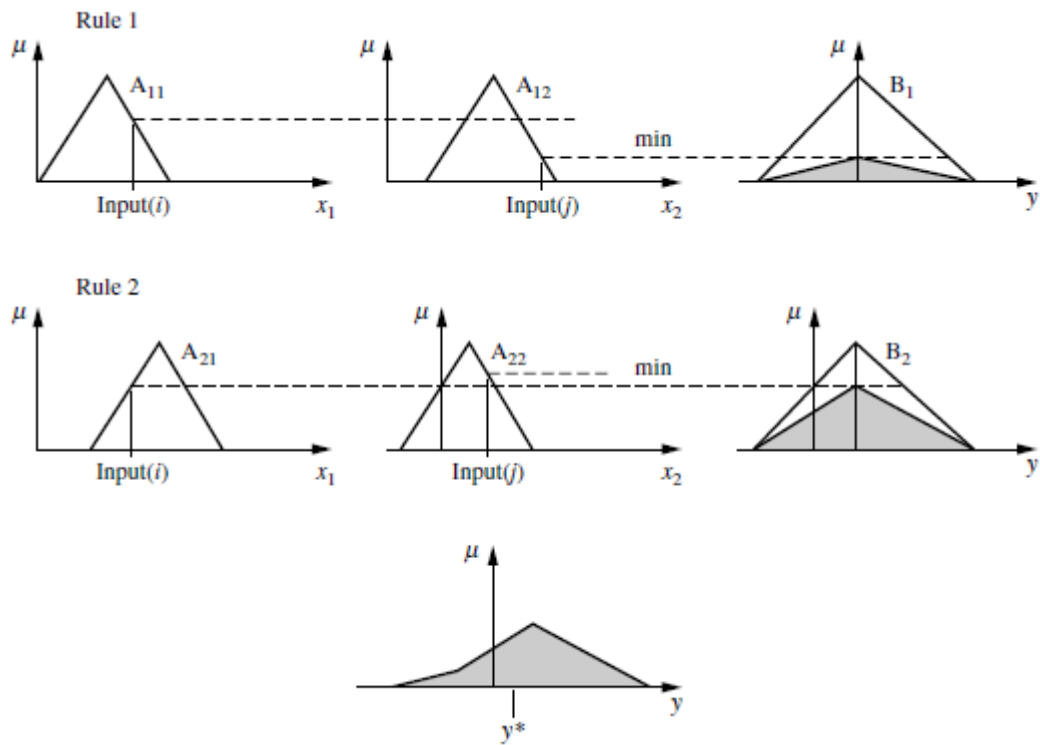

Figure 4.10 Mamdani (max-product) inference technique (Ross, 2004).

Defuzzification

Defuzzification refers to the way a crisp value is extracted from a fuzzy set as a representative value. In general, there are five methods for defuzzifying a fuzzy set A of a universe of discourse Z as follows (Jang, et. al., 1997):

- *Centroid method* is the most commonly used method in practice and is also used to defuzzify the output in this study. It generates the center of gravity of the possibility distribution of a fuzzy set as follows:

$$z^* = \frac{\int \mu_A(z) z dz}{\int \mu_A(z) dz} \quad (4.12)$$

- *Bisector of area method* yields a crisp value z^* that satisfies the following equation:

$$\int_{\alpha}^{z^*} \mu_A(z) dz = \int_{z^*}^{\beta} \mu_A(z) dz \quad (4.13)$$

where $\alpha = \min\{z/z \in Z\}$ and $\beta = \max\{z/z \in Z\}$. That is, the vertical line z^* partitions the aggregated output region into two regions with the same area.

- *Mean of maximum method* yields a crisp value z by calculating the average of the maximizing z at which the MF reaches a maximum μ^* .
- *Smallest of maximum method* yields a crisp value z^* that is the minimum (in terms of magnitude) of the maximizing z .
- *Largest of maximum method* yields a crisp value z^* that is the maximum (in terms of magnitude) of the maximizing z .

4.7.4.2 Takagi-Sugeno Inference Technique

Takagi-Sugeno inference technique was proposed in an effort to develop a systematic approach to generating fuzzy rules from a given input–output data set. A typical rule in a Sugeno model, which has two-inputs x and y , and output z , has the form (Ross, 2004):

$$\text{IF } x \text{ is } A \text{ AND } y \text{ is } B, \text{ THEN } z \text{ is } z = f(x, y) \quad (4.14)$$

where $z = f(x, y)$ is a crisp function in the consequent. When $f(x, y)$ is a first-order polynomial, the resulting fuzzy inference system is called a *first-order TSK*. When f is a constant, we then have a *zero-order TSK*, which can be viewed either as a special case of the Mamdani fuzzy inference system, in which each rule's consequent is specified by a fuzzy singleton or a pre-defuzzified consequent (Jang, et. al., 1997).

Fig. 4.11 illustrates the fuzzy inference process for a first-order TSK. Since each rule has a crisp output, the overall output is obtained via weighted average.

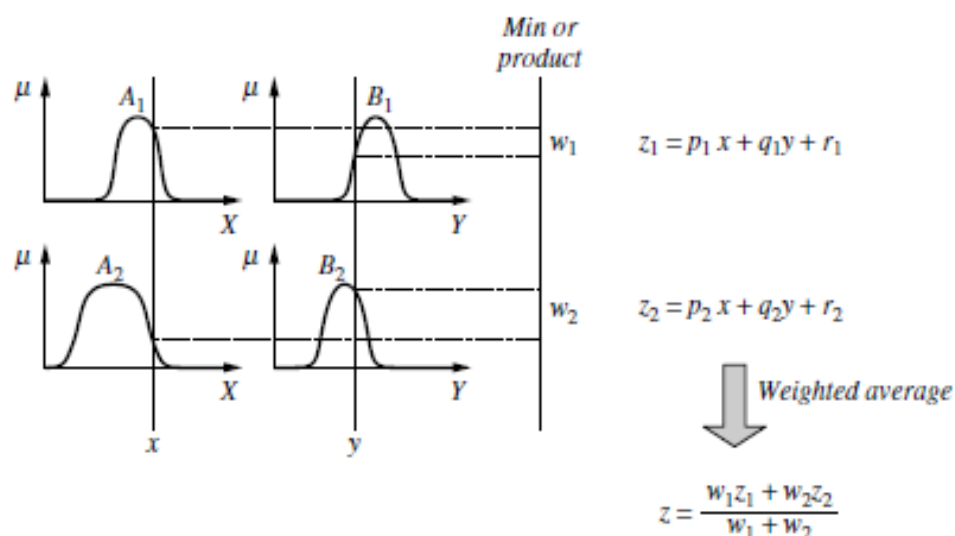

Figure 4.11 TSK fuzzy model (Jang, et. al., 1997).

4.7.4.3 Tsukamoto Inference Technique

In Tsukamoto fuzzy models, the consequent of each fuzzy rule is represented by a fuzzy set with a monotonic MF, as shown in Fig. 4.12. In a monotonic MF, sometimes called a *shoulder function*, the inferred output of each rule is defined as a crisp value induced by the membership value coming from the antecedent clause of the rule. The overall output is calculated by the weighted average of each rule's output, as seen in Fig. 4.12. Since each rule infers a crisp output, there is no need to defuzzify the output. Due to the special nature of the output MFs required by the method, it is not as useful as a general approach, and must be employed in specific situations (Ross, 2004).

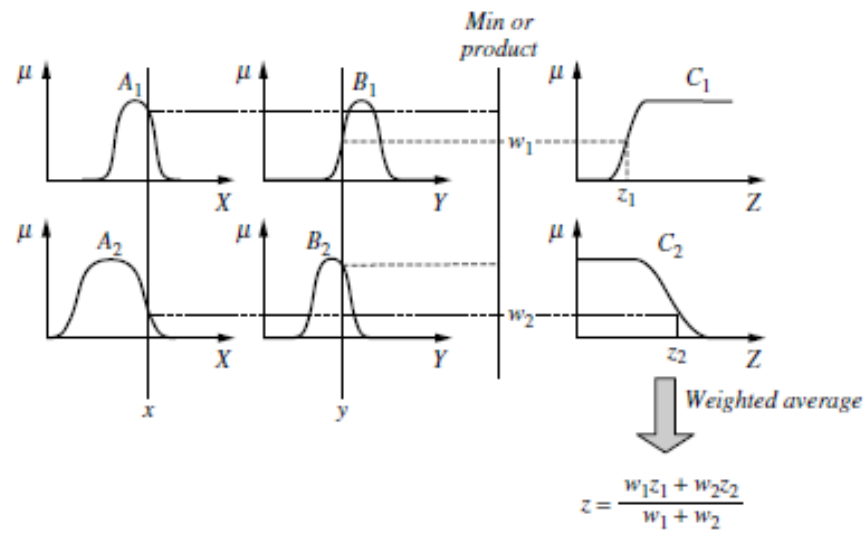

Figure 4.12 Tsukamoto fuzzy model (Jang, et. al., 1997).

CHAPTER FIVE

THE PROPOSED EXPERT SYSTEM FOR STOCK EVALUATION AND PORTFOLIO CONSTRUCTION

In this thesis, an ES that supports portfolio managers in their medium term stock evaluation and portfolio construction decisions in flexible, practical and realistic manner is developed. The proposed ES consists of three stages: Elimination of unacceptable stocks, stock evaluation and portfolio construction. At the initial stage, the stocks that are not preferred by investors are eliminated. At the second stage, acceptable stocks are rated between 0-100 according to their performance by a fuzzy rule-based stock rating system. At the third stage, the stocks that take place in the resulting portfolio and their weights are determined by a mixed integer linear programming model. The process flow diagram of the proposed ES is illustrated in Fig. 5.1.

5.1 Stage 1: Elimination of Unacceptable Stocks

In this stage, the stocks that are not preferred by investors are eliminated. The unacceptable stocks are those that have a negative P/E ratio or a negative shareholder's equity value. For this reason, investors generally do not prefer to invest in these stocks. In this study, the data that are taken into consideration in this stage are the one-year-data that precedes the investment date. Investors can also eliminate some stocks according to their preferences or a specific knowledge about those stocks. This stage reduces the burden on the stock evaluation stage, and prevents the system to suggest unacceptable stocks to user.

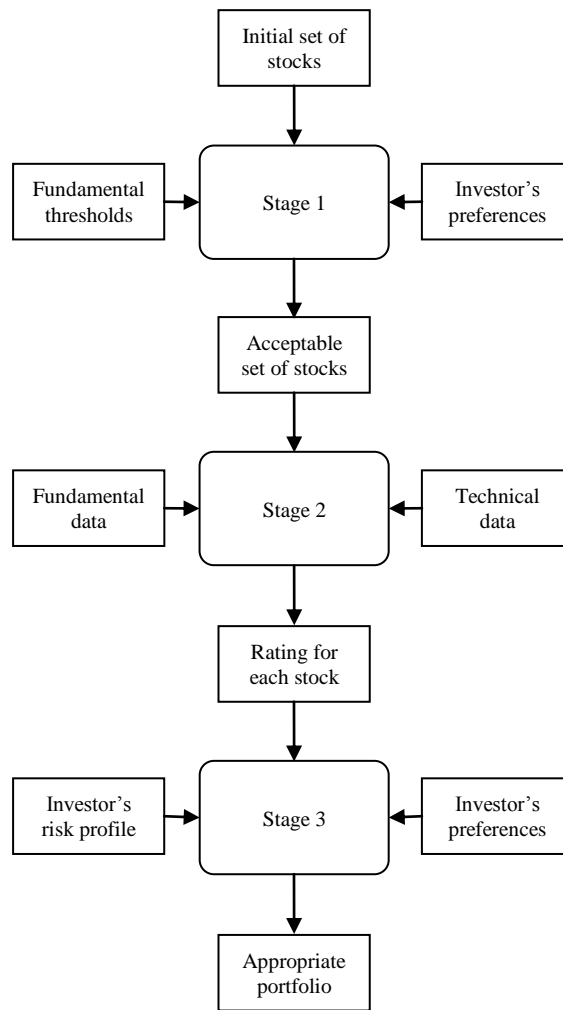

Figure 5.1 Process flow diagram of the proposed ES.

5.2 Stage 2: Stock Evaluation

After the elimination of unacceptable stocks, acceptable stocks are evaluated by using both fundamental and technical inputs. As stated previously, the stocks are evaluated more accurately by considering fundamental and technical inputs together. Inputs of the stock evaluation system are determined based on a comprehensive literature survey and interviews with a domain expert.

The inputs can be classified into two groups; fundamental data and technical data. Fundamental data are obtained from the annual financial statements of the companies that reflect the financial health, competitive advantage and management

performance. However, comparing fundamental ratios of companies from different industry classes is not reasonable due to different characteristics of the industries. For example, the companies in which inventory turnover is very high, have low CR values than the companies in other industries. This low CR value should not be seen as an indicator of poor liquidity performance and should be compared with the other company's CR values that are in the same industry with the company (Reilly & Brown, 2004). For this reason, relative fundamental ratios are used as fundamental inputs of the stock evaluation system and they calculated as follows:

$$\text{relative fundamental ratio} = \frac{\text{fundamental ratio}}{\text{corresponding industry average}} \quad (5.1)$$

If a stock is eliminated in stage 1, fundamental ratios of this stock are left out of corresponding industry average calculation. Therefore, the unacceptable stocks do not affect the stock evaluation process.

By using relative fundamental ratios, the stocks can be evaluated and rated regardless of their industries. Therefore, a single inference system can be used to evaluate the stocks. This provides convenience for the stock evaluation system and makes the proposed ES more practical. Additionally, evaluation of the stocks in a single procedure is also helpful in portfolio construction stage.

In addition to the relative fundamental ratios, ROCs of fundamental ratios are used as fundamental inputs of the stock evaluation system. ROC reflects the trend for the performance of the companies, and is calculated by using Eq. 3.20. However, in this equation, fundamental ratios are used instead of close prices and parameter n is fixed to one year.

As a result, the system has 15 fundamental inputs presented in Table 5.1. Fundamental inputs of stock evaluation system are specified by a comprehensive literature survey and interviews with the domain expert. The proposed stock evaluation system considers three performance dimensions, namely profitability performance, financial risk performance and marketability performance.

In order to measure the profitability performance of the companies under concern, net profit, EBT and ROE are used. In addition, leverage ratio is utilized for financial risk performance. Furthermore, for the marketability performance of the companies MV, P/E, DY and MV/BV are employed. However, we have not used raw fundamental data directly as inputs of the stock evaluation stage due to the reasons explained previously. The stock evaluation system processes raw fundamental data to obtain relative fundamental data and ROCs of fundamental data, and uses these processed data as inputs.

Table 5.1 Fundamental inputs of the stock evaluation system.

Performance dimensions	Fundamental data		
	Raw data	Relative data	ROC of fundamental data
Profitability performance	Net Profit	Relative Net Profit	Net Profit ROC
	EBT	Relative EBT	EBT ROC
	ROE	Relative ROE	ROE ROC
Financial risk performance	Leverage	Relative leverage	Leverage ROC
Marketability performance	MV	Relative MV	
	P/E	Relative P/E	P/E ROC
	DY	Relative DY	DY ROC
	MV/BV	Relative MV/BV	MV/BV ROC

In addition to the fundamental data, technical data are used as inputs for the proposed stock evaluation system. Technical data are based on past price movements and changes in trading volume and widely utilized to predict future movements of stock prices. In this stage, a number of technical indicators are employed as technical inputs namely, price momentum, MACD, BBs and OBV.

As explained previously, price momentum measures speed of price changes and calculated by using Eq. 3.19. In this study, parameter n of Eq. 3.19 is specified as 12 days. On the other hand, MACD is based on a comparison of two MAs with different lags, MACDline and MACDsignal. In this study, MACD indicator is adopted as MACDin, which is a technical input, and calculated as follows:

$$MACDin = MACDline - MACDsignal \quad (5.2)$$

BBs serve as support and resistance levels and obtained by using standard deviation of price from its MA. BBs are calculated by using Eqs. 3.22, 3.23 and 3.24. As recalled, in portfolio management section, BBs are explained in detail. In the stock evaluation process, %B (see Eq. 3.25) is used as a technical indicator. In calculation of the lower BBs and the upper BBs, the parameter K is fixed to 2.

OBV provides a cumulative total volume that represents whether the volume is flowing in or flowing out. OBV indicator is calculated by Eq. 3.31. In the stock evaluation process, two OBV values are calculated for each stock; the OBV value at investment date (OBV_{now}) and the OBV value at the previous day (OBV_{pre}).

As a result, the stock evaluation system has totally 20 inputs. The system evaluates the stocks by considering these inputs and yields the output, *rating*, which changes between 0 and 100, for each stock through a fuzzy inference procedure. The structure of the proposed fuzzy inference system for stock evaluation is illustrated in Fig. 5.2. This inference system is developed in MATLAB environment.

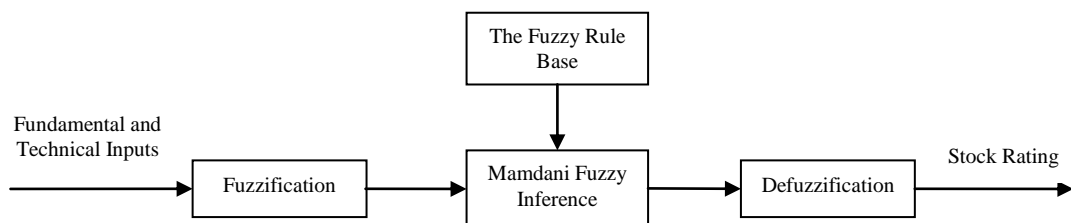

Figure 5.2 Structure of the proposed fuzzy inference system.

Since the inputs of the system are crisp and Mamdani system uses fuzzy inputs and yields fuzzy output, fuzzification of the inputs and the output is needed. In order to fuzzify the inputs, the infimum (*inf*) and supremum (*sup*) of the input data in which one year period that precedes the investment date are obtained. For the output, *inf* value is 0 and the *sup* value is 100. Afterwards, *data range* and median (*center*) of each input and output are calculated by using the *inf* and *sup* values as follows:

$$\text{input data range} = [\text{inf}, \text{sup}] \quad (5.1)$$

$$\text{center} = \frac{\text{sup} - \text{inf}}{2} \quad (5.2)$$

By using the following equations, the inputs and the output are fuzzified by three triangular MFs; low, moderate and high.

$$f(x) = \begin{cases} 0, & x < \text{inf} \\ \frac{x - \text{inf}}{\text{center} - \text{inf}}, & \text{inf} \leq x \leq \text{center} \\ \frac{\text{sup} - x}{\text{sup} - \text{center}}, & \text{center} \leq x \leq \text{sup} \\ 0, & x \geq \text{sup} \end{cases} \quad (5.3)$$

An example to the MFs of fuzzified input data is illustrated in Fig. 5.3. Herein, MACDin data that correspond to time period between 01/10/2009 and 01/10/2010 are fuzzified by triangular MFs using Eq. 5.5.

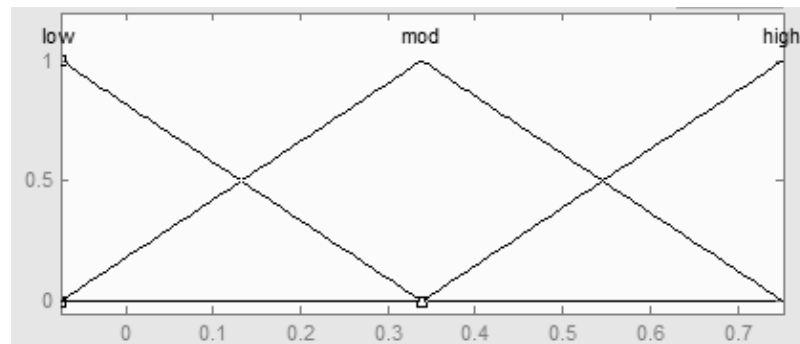

Figure 5.3 MFs of the input variable MACDin.

Specifically, in this stage, the parameters of the MFs are calculated dynamically, by considering one-year-data that precedes investment date, since the standard values of inputs that trigger investment decisions can change over time due to the dynamics of stock market. Thanks to this aspect of the stock evaluation stage, the proposed ES can adjust the parameters of stock evaluation over time in order to conform to new investment environment.

After the inputs and output are specified and fuzzified, a fuzzy rule base is developed by using the domain expert knowledge. The fuzzy rule base is coded in an Excel worksheet that interacts with MATLAB.

Table 5.2 reports the fuzzy rule base that consists of 81 fuzzy rules. Explanation of the abbreviations given in Table 5.2 is presented in Table 5.3. In Table 5.2, each row represents a fuzzy rule. The first column of the table represents the fuzzy rule number, while the columns 2-21 represent the fuzzy rule premises. Additionally, column 22 denotes the consequent of each fuzzy rule, namely, stock rating. Column 23 represents the weight of each fuzzy rule, changing between 0 and 1. It is assumed in this study that all fuzzy rules have equal weight in the inference system. Finally, the last column indicates the conjunction method used to combine the corresponding fuzzy rule's premises. Herein, "1" and "2" symbolizes "AND", "OR" conjunction, respectively.

In columns 2 to 22, each cell contains a number that represents the linguistic variable associated with the premise or the consequent of the corresponding fuzzy rule. Here, the cell value "0" denotes that the input is not used as a premise of the rule, while the cell values "1", "2" and "3" correspond to the linguistic variable "low", "moderate" and "high", respectively. For example, "Rule 1" is stated as follows:

IF OBV_{now} is high AND OBV_{pre} is low THEN the stock rating is high.

As stated previously, the stock evaluation system uses Mamdani inference technique. Since Mamdani systems yield fuzzy output, defuzzification of the output is needed. In this study, centroid method (Eq. 4.12) is used to defuzzify the output.

Table 5.2 The fuzzy rule base.

1	2	3	4	5	6	7	8	9	10	11	12	13	14	15	16	17	18	19	20	21	22	23	24
Rule No	pmom	macdin	obvnow	obvpre	bolin	proroc	relpro	ebtroc	relebt	roeroc	relroe	levroc	rellev	relmcap	peroc	relpe	dyroc	reldy	mvbvroc	relmvbv	rating	weight	and/or(1/2)
1	0	0	3	1	0	0	0	0	0	0	0	0	0	0	0	0	0	0	0	0	3	1	1
2	0	0	1	3	0	0	0	0	0	0	0	0	0	0	0	0	0	0	0	0	1	1	1
3	0	0	2	2	0	0	0	0	0	0	0	0	0	0	0	0	0	0	0	0	2	1	1
4	0	0	0	0	1	0	0	0	0	0	0	0	0	0	0	0	0	0	0	0	3	1	1
5	0	0	0	0	3	0	0	0	0	0	0	0	0	0	0	0	0	0	0	0	1	1	1
6	0	0	0	0	2	0	0	0	0	0	0	0	0	0	0	0	0	0	0	0	2	1	1
7	0	3	0	0	0	0	0	0	0	0	0	0	0	0	0	0	0	0	0	0	3	1	1
8	0	1	0	0	0	0	0	0	0	0	0	0	0	0	0	0	0	0	0	0	1	1	1
9	0	2	0	0	0	0	0	0	0	0	0	0	0	0	0	0	0	0	0	0	2	1	1
10	3	0	0	0	0	0	0	0	0	0	0	0	0	3	0	0	0	0	0	0	3	1	1
11	1	0	0	0	0	0	0	0	0	0	0	0	0	1	0	0	0	0	0	0	1	1	1
12	2	0	0	0	0	0	0	0	0	0	0	0	0	2	0	0	0	0	0	0	2	1	1
13	1	0	0	0	0	0	0	0	0	0	0	0	0	3	0	0	0	0	0	0	2	1	1
14	1	0	0	0	0	0	0	0	0	0	0	0	0	2	0	0	0	0	0	0	1	1	1
15	2	0	0	0	0	0	0	0	0	0	0	0	0	1	0	0	0	0	0	0	1	1	1
16	2	0	0	0	0	0	0	0	0	0	0	0	0	3	0	0	0	0	0	0	3	1	1
17	3	0	0	0	0	0	0	0	0	0	0	0	0	1	0	0	0	0	0	0	2	1	1
18	3	0	0	0	0	0	0	0	0	0	0	0	0	2	0	0	0	0	0	0	3	1	1
19	3	0	0	0	3	0	0	0	0	0	0	0	0	0	0	0	0	0	0	0	1	1	1
20	1	0	0	0	1	0	0	0	0	0	0	0	0	0	0	0	0	0	0	0	2	1	1
21	2	0	0	0	2	0	0	0	0	0	0	0	0	0	0	0	0	0	0	0	2	1	1
22	1	0	0	0	3	0	0	0	0	0	0	0	0	0	0	0	0	0	0	0	1	1	1
23	1	0	0	0	2	0	0	0	0	0	0	0	0	0	0	0	0	0	0	0	1	1	1
24	2	0	0	0	1	0	0	0	0	0	0	0	0	0	0	0	0	0	0	0	3	1	1
25	2	0	0	0	3	0	0	0	0	0	0	0	0	0	0	0	0	0	0	0	2	1	1
26	3	0	0	0	1	0	0	0	0	0	0	0	0	0	0	0	0	0	0	0	3	1	1
27	3	0	0	0	2	0	0	0	0	0	0	0	0	0	0	0	0	0	0	0	3	1	1
28	0	0	0	0	0	0	0	0	0	0	0	1	1	0	0	0	0	0	0	0	3	1	1
29	0	0	0	0	0	0	0	0	0	0	0	2	2	0	0	0	0	0	0	0	2	1	1
30	0	0	0	0	0	0	0	0	0	0	0	3	3	0	0	0	0	0	0	0	1	1	1
31	0	0	0	0	0	0	0	0	0	0	0	1	3	0	0	0	0	0	0	0	2	1	1
32	0	0	0	0	0	0	0	0	0	0	0	1	2	0	0	0	0	0	0	0	2	1	1
33	0	0	0	0	0	0	0	0	0	0	0	2	1	0	0	0	0	0	0	0	3	1	1
34	0	0	0	0	0	0	0	0	0	0	0	2	3	0	0	0	0	0	0	0	1	1	1
35	0	0	0	0	0	0	0	0	0	0	0	3	1	0	0	0	0	0	0	0	2	1	1
36	0	0	0	0	0	0	0	0	0	0	0	3	2	0	0	0	0	0	0	0	1	1	1
37	0	0	0	0	0	0	0	0	0	0	0	0	0	0	0	0	3	3	0	0	3	1	1
38	0	0	0	0	0	0	0	0	0	0	0	0	0	0	0	0	1	1	0	0	1	1	1
39	0	0	0	0	0	0	0	0	0	0	0	0	0	0	0	0	2	2	0	0	2	1	1
40	0	0	0	0	0	0	0	0	0	0	0	0	0	0	0	0	1	3	0	0	2	1	1
41	0	0	0	0	0	0	0	0	0	0	0	0	0	0	0	0	1	2	0	0	1	1	1

Table 5.2 The fuzzy rule base (cont.).

1	2	3	4	5	6	7	8	9	10	11	12	13	14	15	16	17	18	19	20	21	22	23	24
Rule No	pmom	macdin	obvnow	obvpre	bolin	proroc	relpro	ebtroc	relebt	roeroc	relroe	levroc	rellev	relmcap	peroc	relpe	dyroc	relyd	mvbvroc	relmvbv	rating	weight	and/or(1/2)
42	0	0	0	0	0	0	0	0	0	0	0	0	0	0	0	0	2	1	0	0	1	1	1
43	0	0	0	0	0	0	0	0	0	0	0	0	0	0	0	0	2	3	0	0	3	1	1
44	0	0	0	0	0	0	0	0	0	0	0	0	0	0	0	0	3	1	0	0	2	1	1
45	0	0	0	0	0	0	0	0	0	0	0	0	0	0	0	0	3	2	0	0	3	1	1
46	0	0	0	0	0	0	0	0	0	0	0	0	0	0	0	0	0	0	1	1	3	1	1
47	0	0	0	0	0	0	0	0	0	0	0	0	0	0	0	0	0	0	2	2	2	1	1
48	0	0	0	0	0	0	0	0	0	0	0	0	0	0	0	0	0	0	3	3	1	1	1
49	0	0	0	0	0	0	0	0	0	0	0	0	0	0	0	0	0	0	1	3	2	1	1
50	0	0	0	0	0	0	0	0	0	0	0	0	0	0	0	0	0	0	1	2	2	1	1
51	0	0	0	0	0	0	0	0	0	0	0	0	0	0	0	0	0	0	2	1	3	1	1
52	0	0	0	0	0	0	0	0	0	0	0	0	0	0	0	0	0	0	2	3	1	1	1
53	0	0	0	0	0	0	0	0	0	0	0	0	0	0	0	0	0	0	3	1	2	1	1
54	0	0	0	0	0	0	0	0	0	0	0	0	0	0	0	0	0	0	3	2	1	1	1
55	0	0	0	0	0	0	0	0	0	0	0	0	0	0	1	1	0	0	0	0	3	1	1
56	0	0	0	0	0	0	0	0	0	0	0	0	0	0	2	2	0	0	0	0	2	1	1
57	0	0	0	0	0	0	0	0	0	0	0	0	0	0	3	3	0	0	0	0	1	1	1
58	0	0	0	0	0	0	0	0	0	0	0	0	0	0	1	3	0	0	0	0	2	1	1
59	0	0	0	0	0	0	0	0	0	0	0	0	0	0	1	2	0	0	0	0	2	1	1
60	0	0	0	0	0	0	0	0	0	0	0	0	0	0	2	1	0	0	0	0	3	1	1
61	0	0	0	0	0	0	0	0	0	0	0	0	0	0	2	3	0	0	0	0	1	1	1
62	0	0	0	0	0	0	0	0	0	0	0	0	0	0	3	1	0	0	0	0	2	1	1
63	0	0	0	0	0	0	0	0	0	0	0	0	0	0	3	2	0	0	0	0	1	1	1
64	0	0	0	0	0	1	1	1	1	1	1	0	0	0	0	0	0	0	0	0	1	1	1
65	0	0	0	0	0	2	2	2	2	2	2	0	0	0	0	0	0	0	0	0	2	1	1
66	0	0	0	0	0	3	3	3	3	3	3	0	0	0	0	0	0	0	0	0	3	1	1
67	0	0	0	0	0	3	3	3	3	2	2	0	0	0	0	0	0	0	0	0	2	1	1
68	0	0	0	0	0	2	2	3	3	3	3	0	0	0	0	0	0	0	0	0	3	1	1
69	0	0	0	0	0	3	2	3	3	3	2	0	0	0	0	0	0	0	0	0	3	1	1
70	0	0	0	0	0	2	2	3	3	2	2	0	0	0	0	0	0	0	0	0	3	1	1
71	0	0	0	0	0	1	2	1	2	1	1	0	0	0	0	0	0	0	0	0	1	1	1
72	0	0	0	0	0	1	2	1	2	1	1	0	0	0	0	0	0	0	0	0	1	1	1
73	0	0	0	0	0	1	3	1	3	1	3	0	0	0	0	0	0	0	0	0	2	1	1
74	0	0	0	0	0	2	3	2	3	2	3	0	0	0	0	0	0	0	0	0	3	1	1
75	0	0	0	0	0	1	3	1	3	1	3	0	0	0	0	0	0	0	0	0	3	1	1
76	0	0	0	0	0	3	2	3	2	3	2	0	0	0	0	0	0	0	0	0	3	1	1
77	0	0	0	0	0	1	2	1	2	1	2	0	0	0	0	0	0	0	0	0	1	1	1
78	0	0	0	0	0	2	1	2	1	2	1	0	0	0	0	0	0	0	0	0	1	1	1
79	0	0	0	0	0	3	1	3	1	3	1	0	0	0	0	0	0	0	0	0	2	1	1
80	0	0	0	0	0	3	2	3	2	3	2	0	0	0	0	0	0	0	0	0	3	1	1
81	0	0	0	0	0	1	3	1	3	1	3	0	0	0	0	0	0	0	0	0	2	1	1

Table 5.3 Explanation of the abbreviations in the fuzzy rule base.

Abbreviation	Explanation
pmom	The input variable price momentum
macdin	The input variable macdin
obvnow	The input variable OBV_{now}
obvpre	The input variable OBV_{pre}
bolin	The input variable %B indicator
proroc	The input variable net profit ROC
relpro	The input variable relative net profit
ebtroc	The input variable net profit ROC
relebt	The input variable relative net profit
roeroc	The input variable ROE ROC
relroe	The input variable relative ROE
levroc	The input variable leverage ROC
rellev	The input variable relative leverage
relmcap	The input variable relative market capitalization (market value)
peroc	The input variable P/E ROC
relpe	The input variable relative P/E
dyroc	The input variable DY ROC
reldy	The input variable relative DY
mrvbvroc	The input variable MV/BV ROC
relmrvbv	The input variable relative MV/BV
rating	The output variable stock rating
weight	The weight of the fuzzy rule
and/or (1/2)	The conjunction method for the premises of the fuzzy rules (for “and” 1, for “or” 2)

5.3 Stage 3: Portfolio Construction

In this stage, a portfolio that is appropriate to the investor’s preferences and risk profile is constructed by a mixed-integer linear programming model. Despite the proposed ES is developed to support risk averse investors in their middle term investment decisions, it can be adapted to support the investment decision of the other investment risk profiles.

The portfolio construction model developed in this study recommends a portfolio by using the ratings specified in Stage 2, as well as the risk levels and industries of the stocks. The objective function of the model maximizes the total weighted ratings of the stocks that are incorporated in the recommended portfolio:

$$\max Z = \sum_{i=1}^N w_i r_i \quad (5.4)$$

where, N is the number of the stocks, w_i is weight of stock i in the portfolio and r_i is the rating of stock i specified in Stage 2. In recent studies, the objective of the portfolio construction model is to maximize return of the portfolio. However, in this study, the objective of the portfolio construction model is to maximize the total weighted rating of the stocks that are incorporated in the portfolio. Therefore, the model selects the stocks to be incorporated in the portfolio in a more accurate way.

Constraint 5.7 ensures all of available capital is invested.

$$\sum_{i=1}^N w_i = 1, \quad (5.5)$$

Constraint 5.8 is the diversification constraint and sets lower and upper bounds to the number of the stocks in portfolio.

$$LB \leq \sum_{i=1}^N x_i \leq UB, \quad (5.6)$$

where, x_i is the binary variable whose value is 1 if stock i is incorporated in portfolio, and 0 otherwise, LB and UB are lower bound and upper bound for the number of the stocks in portfolio, respectively.

Constraints 5.9 and 5.10 specify the upper and lower bounds for the weights of each stock in portfolio.

$$w_i - UBWx_i \leq 0, \quad i = 1, \dots, N, \quad (5.7)$$

$$w_i - LBWx_i \geq 0, \quad i = 1, \dots, N, \quad (5.8)$$

where, UBW and LBW are upper and lower bounds for weight of a stock in portfolio.

Constraint set 5.11 limits the weights of specific industries in portfolio by considering investor's preferences.

$$\sum_{i \in G_j} w_i \leq UB G_j, \quad \exists G_j, j = 1, \dots, J, \quad (5.9)$$

where, G_j is the set of stocks in industry j , $UB G_j$ is the upper bound for the total weight of stocks in industry j .

Constraint 5.12 sets a lower bound for the total weight of the stocks that have systematic risk (β) less than one.

$$\sum_{i \in BL} w_i \geq LBB \quad (5.10)$$

where, BL is the set of stocks with β less than 1, LBB is the lower bound for the weight of the stocks with β less than one. LBB is specified with respect to investor's risk profile. Specifically, for a risk averse investor, LBB must be set to a high value, in contrast, for a risk prone investor, LBB must be set to a low value.

Finally, constraints 5.13 and 5.14 ensure that w_i is between 0 and 1, and x_i is a binary variable.

$$0 \leq w_i \leq 1 \quad i = 1, \dots, N, \quad (5.11)$$

$$x_i \in \{0,1\} \quad i = 1, \dots, N. \quad (5.12)$$

CHAPTER SIX

APPLICATION

The proposed expert system is validated for the period between 2002 and 2010, by using the data of 61 stocks that are publicly traded in XU100 and are never left out of ISE during the validation period. 28 of the stocks are excluded since they started to be trading in ISE after the validation period begins. Additionally, three of the stocks are excluded due to their special structure of financial statements inherent in their industry. Furthermore, eight of the stocks are excluded due to large amount of lost data for the validation period. At last, 61 stocks specified as the initial set of stocks for validation. These stocks are presented in Table 6.1.

Fundamental data on the stocks are obtained by the financial statements of the companies that are publicly published by ISE and Public Disclosure Platform of Turkey. For calculation of the relative fundamental data, the stocks are grouped into twelve industries referring to industry classification of ISE. This classification and the number of companies in each class are presented in Table 6.2. On the other hand, daily price and volume data (technical data) of the stocks are obtained by ISE.

As stated previously, stock evaluation is performed by considering the one-year-data that precedes the investment dates. Additionally, the length of the investment period is specified as six months since the proposed ES is developed to support medium term investment decisions. On the other hand, in portfolio construction stage, lower and upper bounds for diversification constraint (constraint 5.8) are set to 7 and 14, respectively. In constraints 5.9 and 5.10, the lower and upper bounds for the portfolio weights are determined as 0.02 and 0.20, respectively, for each stock. Additionally, in constraint set 5.11, the upper bounds for the weights of the industries in the portfolio are specified as follows; 0.03 for industries 2 and 10, 0.05 for industry 7, 0.07 for industries 3 and 12, 0.08 for industries 5 and 8, and 0.25 for the other industries. In constraint 5.12, *LBB* value is set to 0.65, since the proposed ES is developed to support risk averse investors in their medium term investment decisions.

Table 6.1 The set of stocks selected for validation.

No	Stock Code	Company
1	ADNAC	ADANA ÇİMENTO SANAYİİ T.A.Ş.
2	AEFES	ANADOLU EFES BİRACILIK VE MALT SANAYİİ A.Ş.
3	AFYON	AFYON ÇİMENTO SANAYİ T.A.Ş.
4	AKBNK	AKBANK T.A.Ş.
5	AKENR	AKENERJİ ELEKTRİK ÜRETİM A.Ş.
6	AKSA	AKSA AKRİLİK KİMYA SANAYİİ A.Ş.
7	ALARK	ALARKO HOLDİNG A.Ş.
8	ARCLK	ARÇELİK A.Ş.
9	ASELS	ASELSAN ELEKTRONİK SANAYİ VE TİCARET A.Ş.
10	AYGAZ	AYGAZ A.Ş.
11	BAGFS	BAGFAŞ BANDIRMA GÜBRE FABRİKALARI A.Ş.
12	BANVT	BANVİT BANDIRMA VİTAMİNLİ YEM SANAYİİ A.Ş.
13	BRISA	BRİSA BRIDGESTONE SABANCI LASTİK SAN. VE TİC. A.Ş.
14	DEVA	DEVA HOLDİNG A.Ş.
15	DOHOL	DOĞAN ŞİRKETLER GRUBU HOLDİNG A.Ş.
16	ECILC	EİS ECZACIBAŞI İLAÇ, SİNAİ VE FİNANSAL YATIRIMLAR SANAYİ VE TİCARET A.Ş.
17	ECZYT	ECZACIBAŞI YATIRIM HOLDİNG ORTAKLIĞI A.Ş.
18	EGGUB	EGE GÜBRE SANAYİİ A.Ş.
19	EGSER	EGE SERAMİK SANAYİ VE TİCARET A.Ş.
20	EREGL	EREĞLİ DEMİR VE ÇELİK FABRİKALARI T.A.Ş.
21	FROTO	FORD OTOMOTİV SANAYİ A.Ş.
22	GARAN	T.GARANTİ BANKASI A.Ş.
23	GOLDS	GOLDAŞ KUYUMCULUK SANAYİ İTHALAT İHRACAT A.Ş.
24	GOODY	GOODYEAR LASTİKLERİ T.A.Ş.
25	GSDHO	GSD HOLDİNG A.Ş.
26	GUBRF	GÜBRE FABRİKALARI T.A.Ş.
27	HURGZ	HÜRRİYET GAZETECİLİK VE MATBAACILIK A.Ş.
28	ISCTR	T.İŞ BANKASI A.Ş.
29	ISYHO	İŞIKLAR YATIRIM HOLDİNG A.Ş.
30	IZMDC	İZMİR DEMİR ÇELİK SANAYİ A.Ş.
31	KARSN	KARSAN OTOMOTİV SANAYİİ VE TİCARET A.Ş.
32	KARTN	KARTONSAN KARTON SANAYİ VE TİCARET A.Ş.
33	KCHOL	KOÇ HOLDİNG A.Ş.
34	KIPA	TESCO KİPA KİTLE PAZARLAMA TİCARET VE GIDA SANAYİ A.Ş.
35	KONYA	KONYA ÇİMENTO SANAYİİ A.Ş.
36	KRDMD	KARDEMİR KARABÜK DEMİR ÇELİK SANAYİ VE TİCARET A.Ş.
37	METRO	METRO TİCARİ VE MALİ YATIRIMLAR HOLDİNG A.Ş.
38	MGROS	MİGROS TİCARET A.Ş.
39	NETAS	NORTEL NETWORKS NETAŞ TELEKOMÜNİKASYON A.Ş.
40	NTHOL	NET HOLDİNG A.Ş.
41	NTTUR	NET TURİZM TİCARET VE SANAYİ A.Ş.
42	PETKM	PETKİM PETROKİMYA HOLDİNG A.Ş.

Table 6.1 (cont.).

No	Stock Code	Company
43	PRKME	PARK ELEKTRİK ÜRETİM MADENCİLİK SANAYİ VE TİCARET A.Ş.
44	PTOFS	PETROL OFİSİ A.Ş.
45	SAHOL	H.Ö. SABANCI HOLDING A.Ş.
46	SASA	ADVANSA SASA POLYESTER SANAYİ A.Ş.
47	SISE	T.ŞİŞE VE CAM FABRİKALARI A.Ş.
48	SKBNK	ŞEKERBANK T.A.Ş.
49	TCELL	TURKCELL İLETİŞİM HİZMETLERİ A.Ş.
50	TEBNK	TÜRK EKONOMİ BANKASI A.Ş.
51	TEKST	TEKSTİL BANKASI A.Ş.
52	TEKTU	TEK-ART İNŞAAT TİCARET TURİZM SANAYİ VE YATIRIMLAR A.Ş.
53	THYAO	TÜRK HAVA YOLLARI A.O.
54	TIRE	MONDİ TİRE KUTSAN KAĞIT VE AMBALAJ SANAYİ A.Ş.
55	TOASO	TOFAŞ TÜRK OTOMOBİL FABRİKASI A.Ş.
56	TRKCM	TRAKYA CAM SANAYİİ A.Ş.
57	TSKB	T.SINAI KALKINMA BANKASI A.Ş.
58	TUPRS	TÜPRAŞ-TÜRKİYE PETROL RAFİNERİLERİ A.Ş.
59	VESTL	VESTEL ELEKTRONİK SANAYİ VE TİCARET A.Ş.
60	YKBNK	YAPI VE KREDİ BANKASI A.Ş.
61	ZOREN	ZORLU ENERJİ ELEKTRİK ÜRETİM A.Ş.

The performance of the proposed ES is measured for the validation period by using the return and risk adjusted return measures presented in Chapter 3. For performance evaluation of the portfolios constructed by the proposed ES, XU030 is used as the benchmark index. Performances of the portfolios are compared with the benchmark index for different portfolio holding period lengths and risk profiles. Firstly, the performance of the system is measured for different risk profiles of investors; risk averse, risk neutral and risk prone. Afterwards, the effect of investment period length on the performance of the proposed system is investigated using different investment period lengths, three, six, nine and twelve-month periods.

Table 6.2 Industry classification of ISE and number of companies in each class.

No	Industry Class	Number of companies
1	Banks and private financial institutions	8
2	Electricity, gas and water	2
3	Food, beverage and tobacco	3
4	Holding and investment companies	8
5	Paper, paper products, printing and publication	4
6	Chemistry, petroleum, rubber and plastic products	13
7	Restaurants and hotels	2
8	Basic metal industry	3
9	Metal goods, machinery and equipment construction	7
10	Retailers	2
11	Stone and land based industries	6
12	Transportation, communication and storage	3

6.1 Performance Evaluation for Different Risk Profiles

In this section, performance of the proposed ES is evaluated for different risk profiles; risk averse, risk neutral and risk prone. As stated previously, length of the investment period is set to six months in the performance evaluation. At the end of each investment period, all stocks in the portfolio are sold and a new portfolio is constructed by the proposed ES. Specifically, as the length of the validation period is nine years (between the years 2002 and 2010) and the length of investment period is six months, totally 18 portfolios are constructed by the ES during the validation period.

Investor's risk profile directly affects the portfolio construction stage of the proposed ES. In the portfolio construction stage, risk profile is defined in constraint 5.12. Herein, the value of *LBB* can be adjusted according to investor's risk profile. Specifically, for a risk averse investor, *LBB* is high and for a risk prone investor, *LBB* is low. In this study, *LBB* values are specified as 0.35, 0.50 and 0.65 for risk prone, risk neutral and risk averse investors, respectively.

As stated previously, performance of the proposed system is evaluated in return basis by using return measures such as compound return and average monthly return,

as well as in risk adjusted return basis by using Treynor, Sharpe, Jensen's alpha and IR. The return and risk adjusted return performances of the portfolios constructed by the proposed ES for different risk profiles, and the performance of the benchmark index in the corresponding periods are reported in Appendices A and C2, respectively. The results of the performance evaluation are presented in comparison with the benchmark index, subsequently.

Fig. 6.1 illustrates the performance evaluation results of the proposed ES in terms of compound return. As reported, 15 of 18 portfolios yield higher compound returns than the benchmark index yields. The minimum, mean and maximum excess returns of the proposed ES relative to the benchmark index for different risk profiles are presented in Table 6.3. It can be concluded from the results that there is no significant difference between the performance of the proposed ES and of the benchmark index in terms of compound return for different risk profiles. According to opinion of the domain expert, the performance of the proposed system is decisive when the market is in decline. As seen in Fig. 6.1, in declining periods (when the compound return of XU100 is negative), the portfolios constructed by the proposed ES lost less than the market and benchmark indices, generally.

Fig. 6.2 illustrates the performance of the proposed ES in terms of average monthly return. As seen in the figure, 14 of 18 portfolios constructed by the proposed system have higher average monthly returns than the market and benchmark indices. The minimum, mean and maximum excess monthly returns relative to the benchmark index are reported in Table 6.3. Additionally, the portfolios generally show superior performance relative to the benchmark index in terms of average monthly return when market is declining.

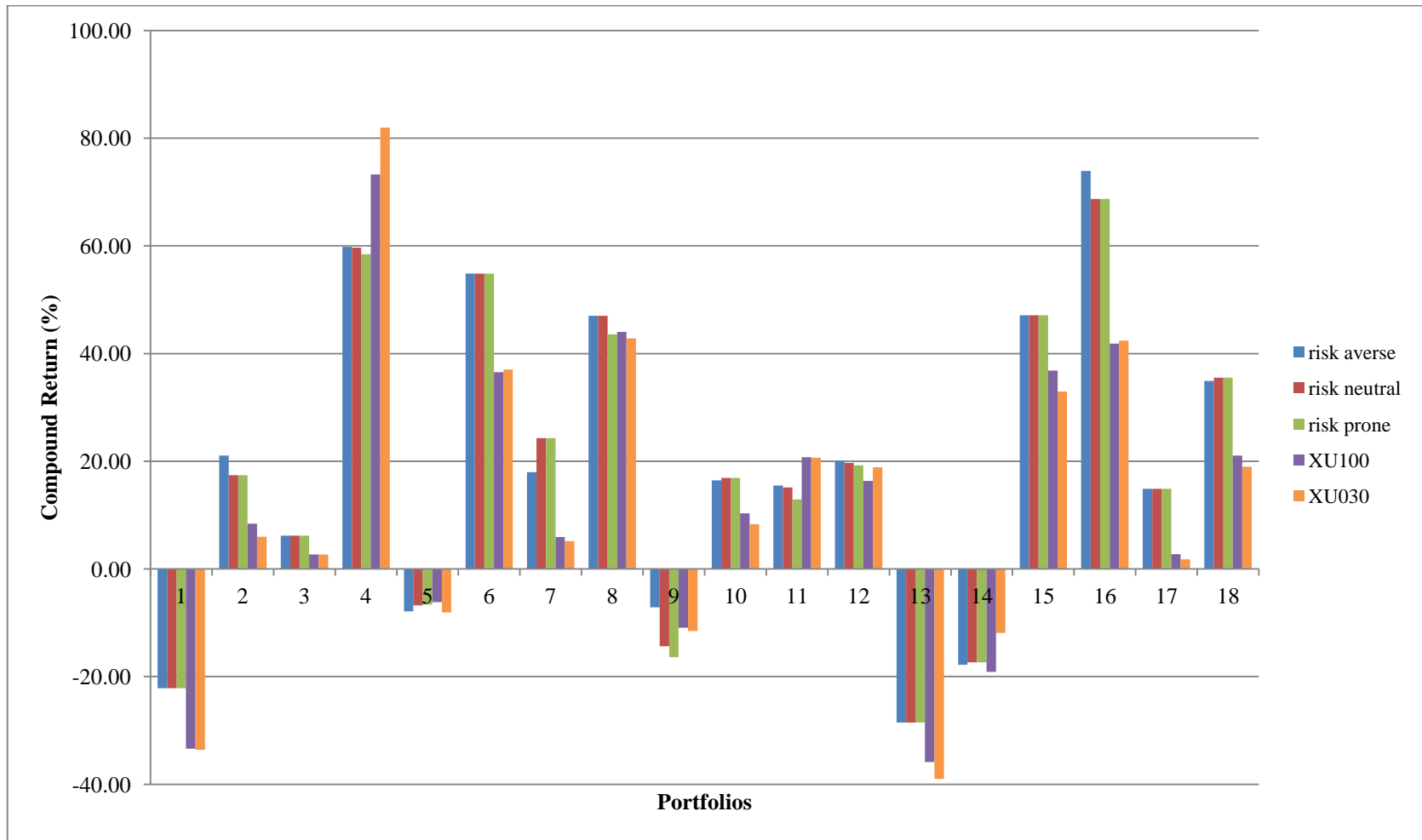

Figure 6.1 Performance evaluation results of the proposed ES in terms of compound return for different risk profiles.

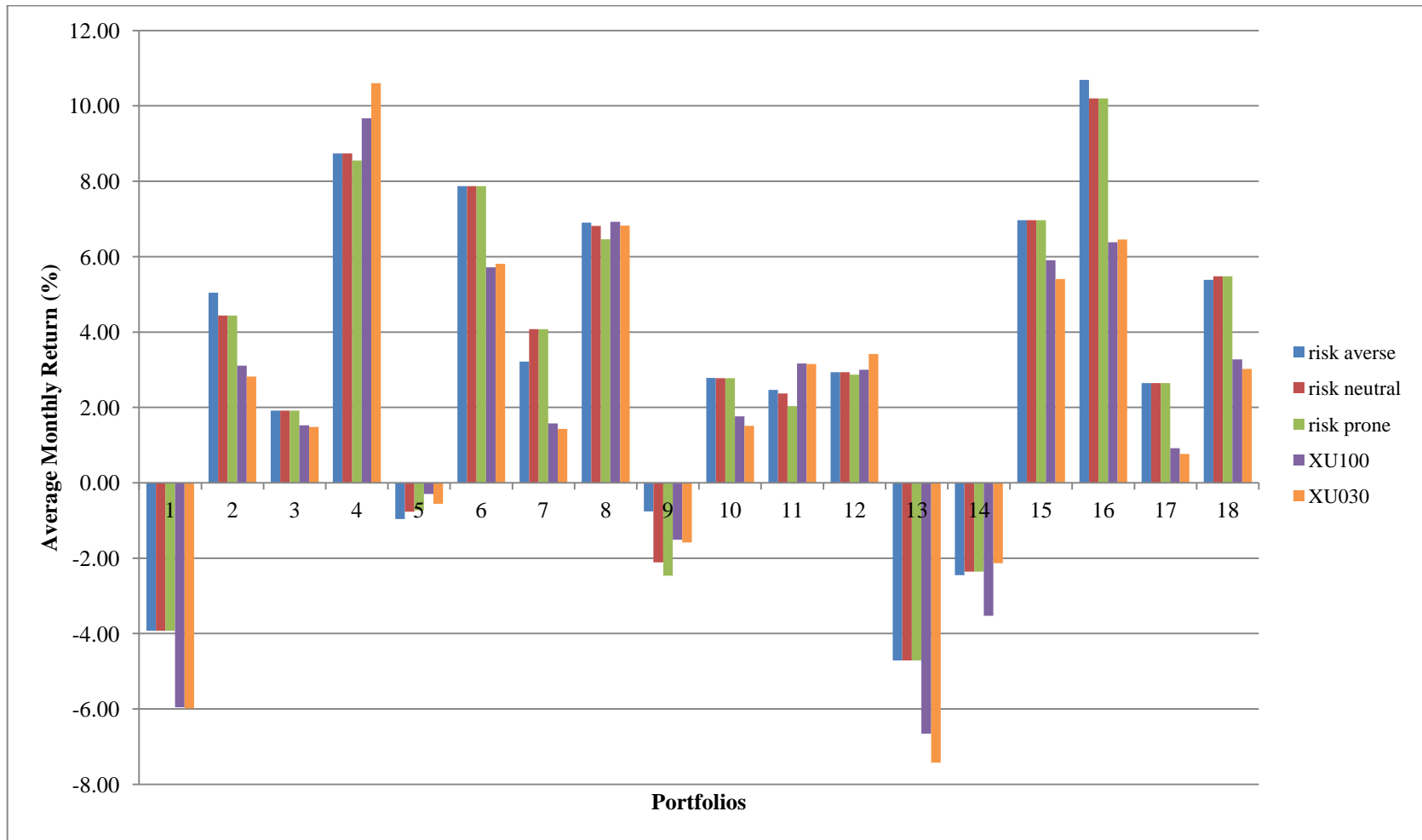

Figure 6.2 Performance evaluation results of the proposed ES in terms of average monthly return for different risk profiles.

However, return measures are not sufficient to evaluate the portfolio performance. Therefore, several risk adjusted return measures are utilized in this study for the performance evaluation. Fig. 6.3 illustrates the performance evaluation of the proposed ES in terms of Treynor ratio. As seen, 14 of 18 portfolios show superior performance relative to the benchmark index in terms of Treynor ratio in case of risk averse investor. Conversely, in cases of risk neutral and risk prone investors, Treynor ratios of ninth and twelfth portfolios are lower than that of the benchmark index. Treynor ratios of the portfolios constructed by the proposed ES relative to the benchmark index are also reported in Table 6.3.

Fig. 6.4 represents the performance evaluation of the proposed ES in terms of Sharpe ratio for different risk profiles. The results reveal that for risk averse investor, 13 of 18 portfolios and for risk neutral and risk prone investors, 12 of 18 portfolios show superior performance relative to the benchmark index in terms of Sharpe ratio. The risk adjusted returns in terms of Sharpe ratio relative to the benchmark index are presented in Table 6.3.

Fig. 6.5 demonstrates the performance evaluation of the proposed ES in terms of Jensen's alpha. The results show that 14 of 18 portfolios constructed by the proposed ES have higher Jensen's alphas than the benchmark index for risk averse investor. However, in cases of risk neutral and risk prone investors, Jensen's alphas of the ninth and twelfth portfolios are lower than that of the benchmark index. Jensen's alphas of the portfolios constructed by the proposed ES relative to the benchmark index are reported in Table 6.3. It can be concluded from the results that the proposed ES yields very high risk adjusted returns in terms of Jensen's alpha relative to the benchmark index. Although the variability of Jensen's alphas is very high, only 4 of 18 portfolios have lower Jensen's alphas than those of the benchmark index during the validation period.

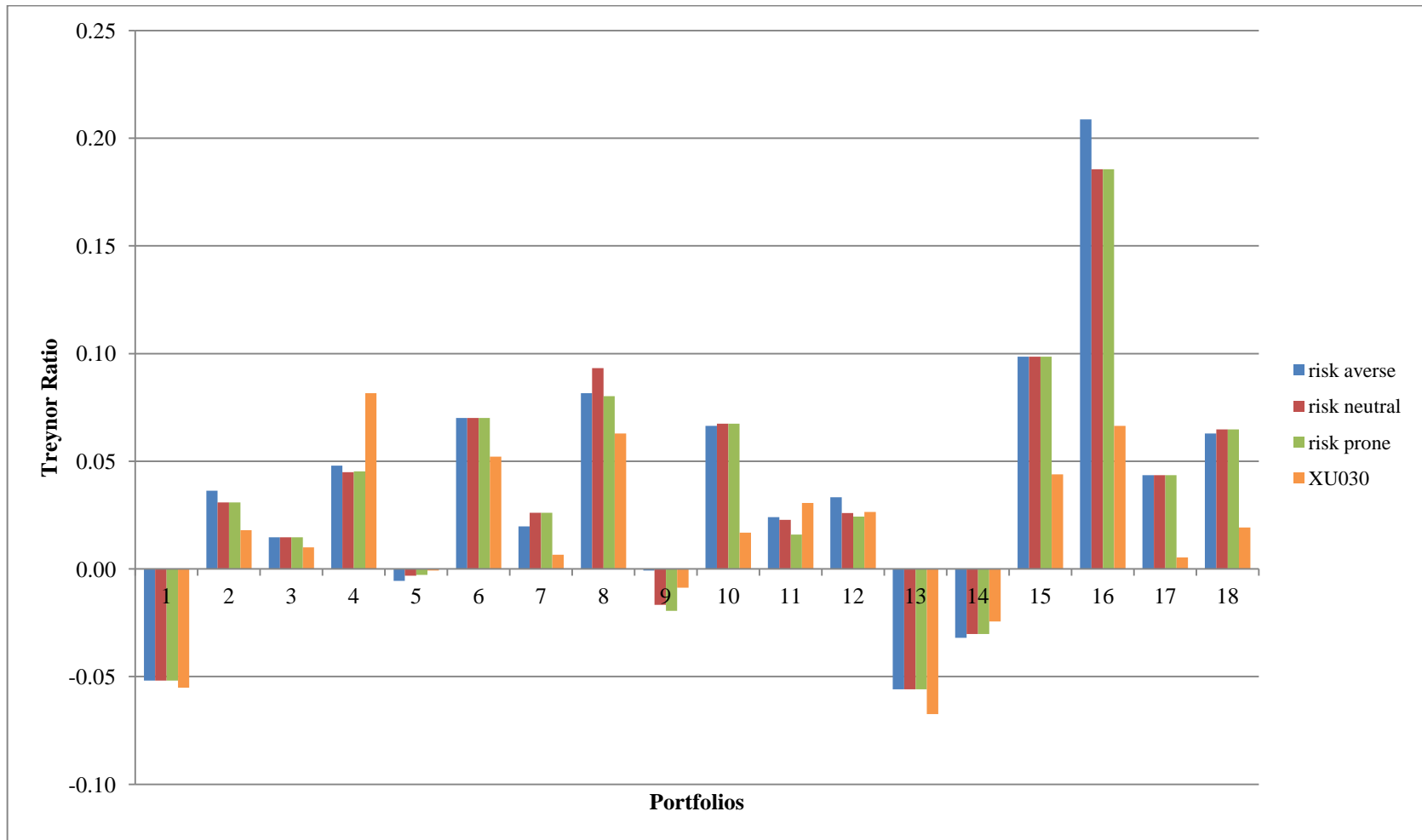

Figure 6.3 Performance evaluation results of the proposed ES in terms of Treynor ratio for different risk profiles.

Table 6.3 Performance evaluation results relative to benchmark index for different risk profiles.

Performance measures	Risk profiles								
	risk averse			risk neutral			risk prone		
	min	mean	max	min	mean	max	min	mean	max
Compound Return	-49.91%	95.97%	730.40%	-46.05%	96.42%	730.40%	-46.05%	94.29%	730.40%
Avg. Monthly Return	-73.46%	41.87%	245.47%	-37.80%	40.99%	245.47%	-55.79%	38.95%	245.47%
Treynor Ratio	-667.32%	76.18%	720.17%	-333.67%	86.65%	720.17%	-284.49%	84.91%	720.17%
Sharpe Ratio	-561.24%	33.96%	317.41%	-98.05%	-34.37%	92.80%	-240.42%	40.16%	317.41%
Jensen's Alpha	-740.30%	1722.71%	16115.05%	-1052.24%	240.51%	1783.13%	-1664.11%	1541.60%	16115.05%
IR	-0.4970	0.1742	0.6882	-0.4161	0.1546	0.6882	-0.4482	0.1404	0.6882

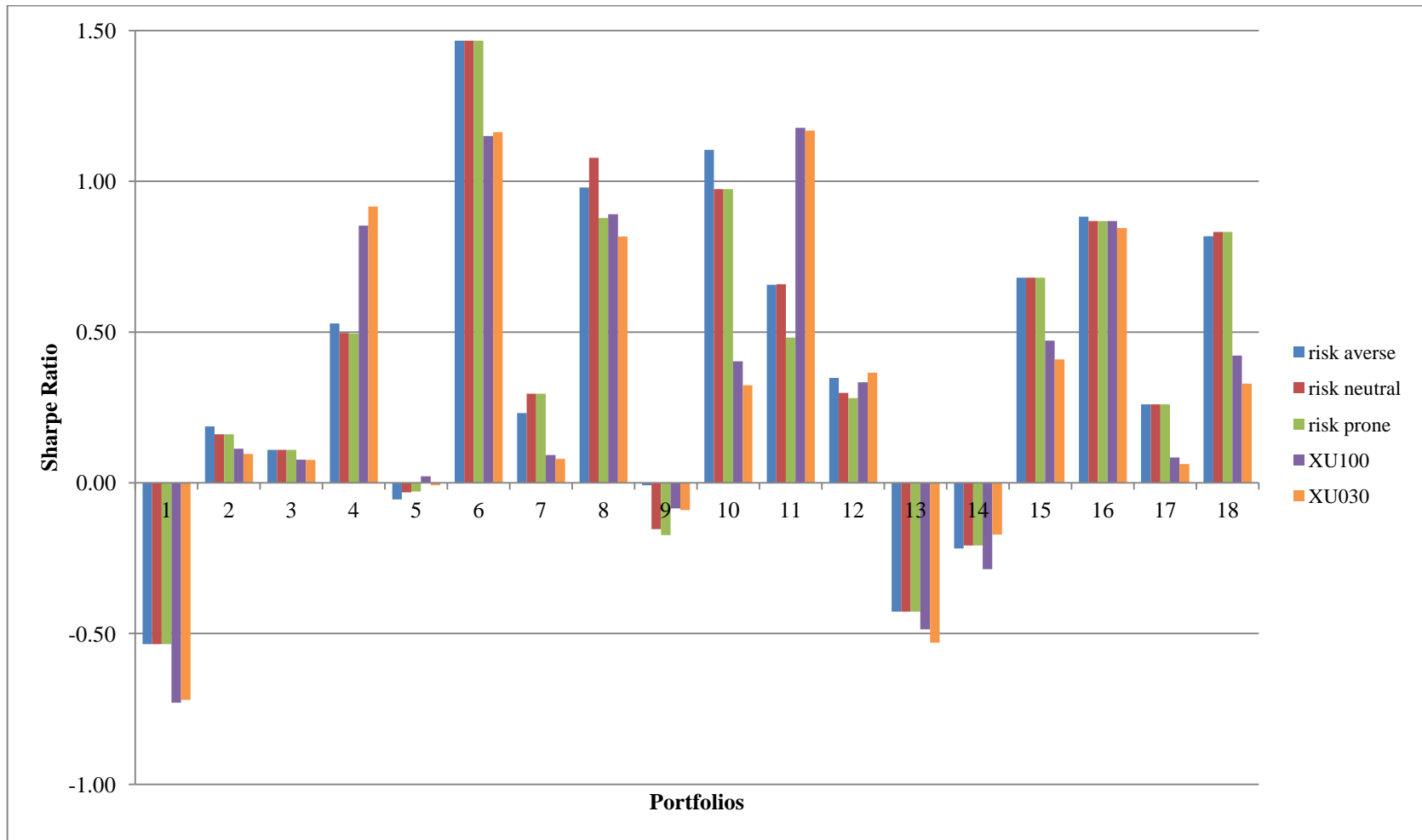

Figure 6.4 Performance evaluation results of the proposed ES in terms of Sharpe ratio for different risk profiles.

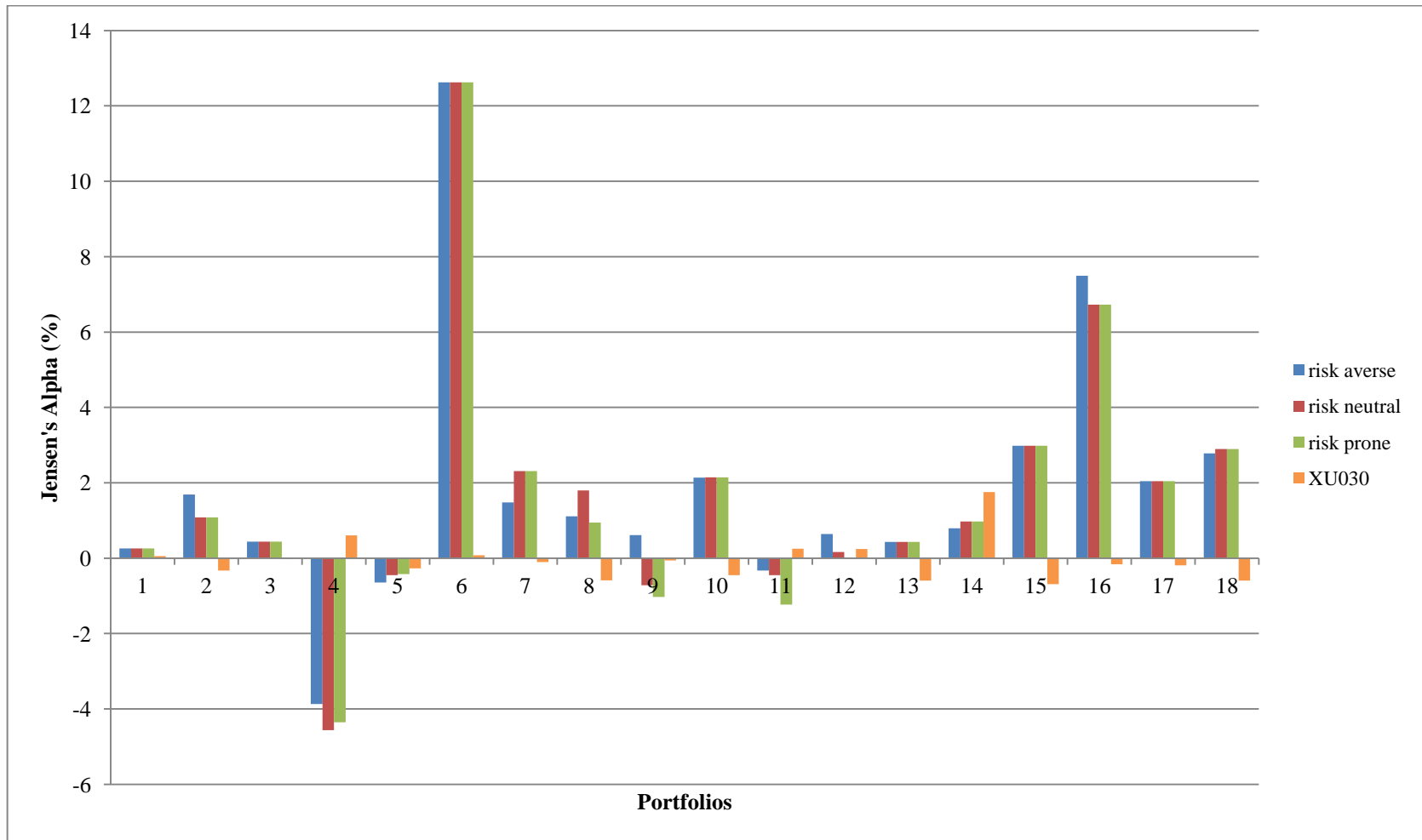

Figure 6.5 Performance evaluation results of the proposed ES in terms of Jensen's alpha for different risk profiles.

Table 6.4 presents the performance evaluation of the portfolios constructed by the proposed ES in terms of IR for different risk profiles. The average IRs of the portfolios for risk averse, risk neutral and risk prone investors are 0.1742, 0.1546 and 0.1404, respectively. The results reveal that the portfolios constructed in risk averse investor case generally show better performance than the other portfolios in terms of IR.

Goodwin (1998) examined over 200 professional portfolio managers over a ten year period and found that although the median IR was positive, it never exceeded 0.5. The results obtained in this work are in parallel to Goodwin's study; the medians of IRs of the portfolios constructed by the proposed ES are positive and lower than 0.5, namely, 0.0956, 0.1361 and 0.1200 for risk averse, risk neutral and risk prone investors, respectively. However, in some periods, IR values are very close to 0.5, even it exceeds 0.5 in 13th period.

Table 6.4 IR values of the portfolios constructed by the proposed ES for different risk profiles.

Portfolios	IR		
	risk averse	risk neutral	risk prone
1	0.4206	0.4206	0.4206
2	0.3296	0.2803	0.2803
3	0.1276	0.1276	0.1276
4	-0.4970	-0.4161	-0.4482
5	-0.0696	-0.0377	-0.0325
6	0.2204	0.2204	0.2204
7	0.4776	0.5388	0.5388
8	0.0218	-0.0015	-0.0736
9	0.2319	-0.1066	-0.1552
10	0.3607	0.3342	0.3342
11	-0.2172	-0.2977	-0.3936
12	-0.0905	-0.1024	-0.1155
13	0.6882	0.6882	0.6882
14	-0.0665	-0.0505	-0.0505
15	0.2082	0.2082	0.2082
16	0.3328	0.3086	0.3086
17	0.1915	0.1915	0.1915
18	0.4665	0.4773	0.4773

In conclusion, there is no significant difference in performances between the cases of different risk profiles. However, the performance of the proposed ES is inferior in five periods for the risk averse investor case, while the performance is inferior in seven periods for risk neutral and risk prone investor cases. It can be concluded here that despite the variability in the performance level, the proposed ES shows better performance in the risk averse investor case, in parallel to our expectations.

6.2 Performance Evaluation for Different Investment Period Lengths

In this section, performance of the proposed ES is evaluated for different investment period lengths, namely, three months, six months, nine months and twelve months. In performance evaluation process, it is assumed that the investor is risk averse. As stated previously, during the validation, all stocks in the portfolio are sold and a new portfolio is constructed by the proposed ES at the end of each investment period. Specifically, as the length of the validation period is nine years (between 2002 and 2010); 36, 18, 12 and 9 portfolios are constructed for 3, 6, 9 and 12-month investment periods, respectively. The performance evaluation results of the proposed ES in cases of different investment period lengths are presented in Appendix B. Additionally, the performances of the benchmark index for different investment period lengths are demonstrated in Appendix C.

As illustrated in Fig. 6.6, for the 9-month investment period, the proposed ES yields higher average compound returns relative to the benchmark index. However, in terms of average monthly return relative to benchmark index, the proposed ES has better performance in case of 12-month investment period. As presented in Table 6.5, the return performance of the proposed ES is variable, but on average, it is considerably higher in all cases than that of the benchmark index.

In risk adjusted return basis, the performance of the proposed ES is better for all cases than that of the benchmark index on average. As illustrated in Fig. 6.6, average Treynor ratios of the portfolios constructed by the proposed system in case of 9-month investment period relative to the benchmark index are higher than those of the

portfolios constructed in other cases. On the other hand, Sharpe ratios of the proposed portfolios in case of 3-month investment period are higher on average relative to benchmark index than those of the portfolios constructed for the other periods. Finally, in terms of Jensen's alpha and IR, the portfolios constructed for 6-month investment period show better performance than those constructed for the other periods.

As stated previously, the proposed ES is developed to support medium term investment decisions, and the length of the investment period is specified as six months. Therefore, the proposed ES is expected to show superior performance relative to the benchmark index in medium term investment cases. As reported in Table 6.5, the performance of the proposed ES is better than that of the benchmark index on average in cases of 6-month, 9-month and 12-month investment period lengths as expected. Additionally, it should be emphasized that in case of 3-month investment period length, the proposed ES show superior performance relative to the benchmark index, as well.

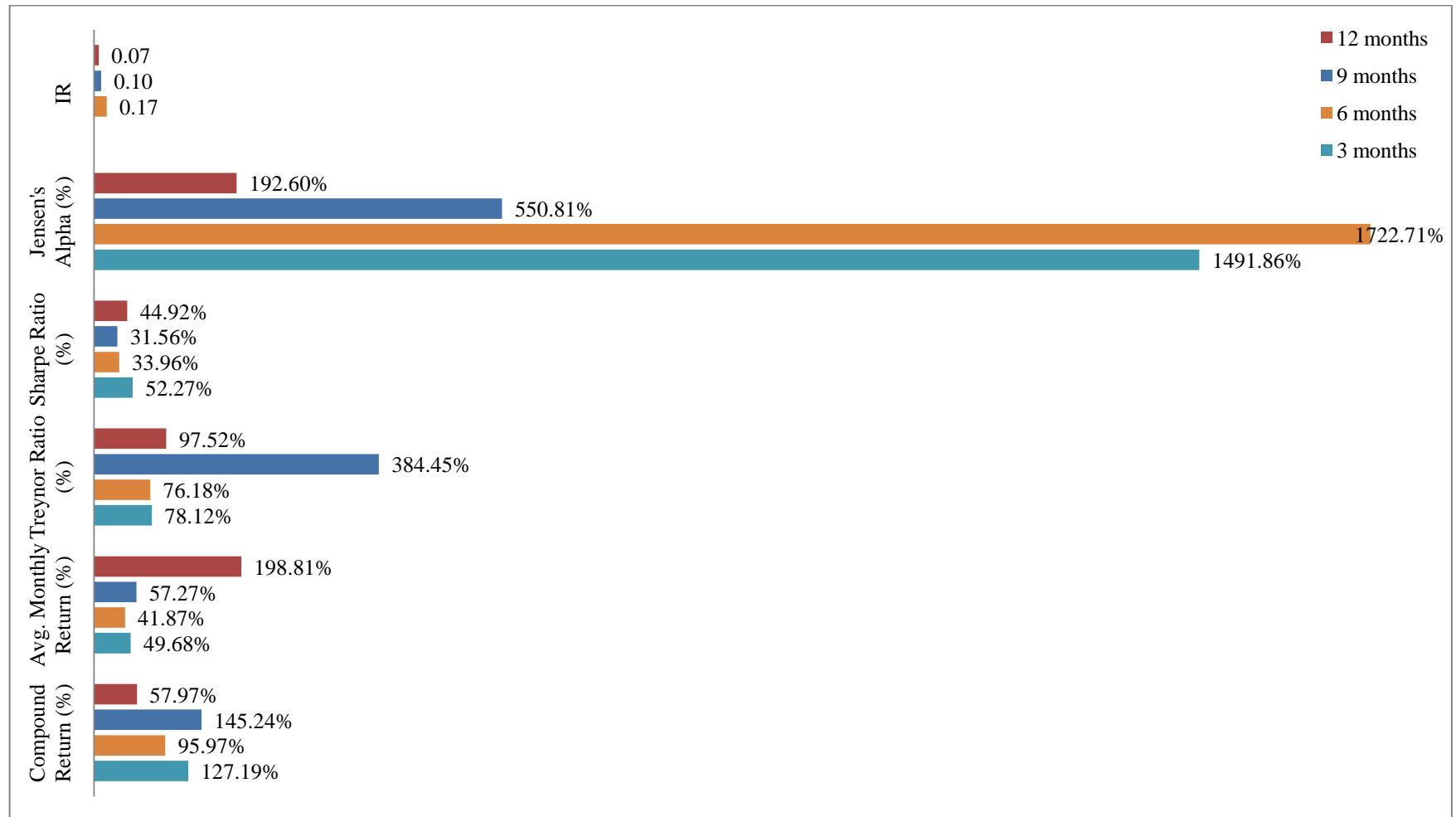

Figure 6.6 Average performance levels relative to benchmark index for different investment period lengths.

Table 6.5 Performance evaluation results relative to benchmark index for different investment period lengths.

Investment period length	3 months			6 months			9 months			12 months		
Performance measures	min	mean	max	min	mean	max	min	mean	max	min	mean	max
Compound Return	-312.91%	127.19%	2171.33%	-49.91%	95.97%	730.40%	-31.51%	145.24%	808.53%	-81.54%	57.97%	216.12%
Avg. Monthly Return	-250.09%	49.68%	825.42%	-73.46%	41.87%	245.47%	-20.66%	57.27%	458.35%	-72.77%	198.81%	1519.69%
Treynor Ratio	-317.76%	78.12%	1992.47%	-667.32%	76.18%	720.17%	-92.35%	384.45%	4009.86%	-82.27%	97.52%	371.85%
Sharpe Ratio	-178.01%	52.27%	689.30%	-561.24%	33.96%	317.41%	-61.70%	31.56%	243.85%	-84.39%	44.92%	170.21%
Jensen's Alpha	-21927.87%	1491.86%	66957.37%	-740.30%	1722.71%	16115.05%	-5292.52%	550.81%	7004.03%	-3134.21%	192.60%	1510.97%
IR	-3.41	-0.0004	2.53	-0.50	0.1742	0.69	-0.53	0.0982	0.70	-0.74	0.0666	0.31

Particularly, as presented in Appendix B, 15 of 36, 4 of 18, 3 of 12 and 3 of 9 portfolios constructed by the proposed ES has inferior performance, generally, in cases of 3, 6, 9 and 12 month-investment period lengths, respectively. It can be concluded from the results that the proposed ES is more appropriate to the cases of 6, 9 and 12-month investment periods rather than 3-month investment period case. In other words, the proposed ES provides relatively better results for the middle term investments compared to the short-term investments, in parallel to our expectations.

In general, the performance of the proposed system are inferior in the second half of 2003, first halves of 2004 and 2007, and the second half of 2008. These periods correspond to some political or economic crisis in local or global scale. These unpredictable circumstances affected the financial markets dramatically. Consequently, the performance of the proposed ES is inferior in these periods.

CHAPTER SEVEN

CONCLUSION

Stock evaluation and portfolio construction problem is dealt with in this thesis. The aim of this study is constructing an appropriate portfolio that meets investor's risk profile and specific preferences, rather than constructing an optimal portfolio that is just a collection of individual assets having desirable risk-return characteristics. However, this makes the problem more complex and unstructured. In addition, the problem becomes a MCDM problem that includes many interacting fundamental and technical criteria and contains high level of uncertainty. Therefore, a fuzzy rule based ES is thought to be an appropriate solution to this problem. Then, a fuzzy rule based ES is developed in this study to support portfolio managers in their middle term stock evaluation and portfolio construction decisions.

In this thesis, stock evaluation and portfolio construction stages of portfolio management are dealt in an integrated framework. In this framework, investor's preferences and risk profile are taken into account in all stages. Specifically, in recent studies, portfolio construction stage is not well structured. In this study, in portfolio construction stage, a portfolio that is appropriate to investor's preferences and risk profile is constructed by a mixed integer linear programming model that selects the stocks with high ratings for the portfolio.

The proposed ES can be characterized by its realistic, flexible and practical aspects. As the proposed ES uses relative fundamental ratios and calculates the data ranges dynamically, in fuzzification of inputs, it can be employed in solving real-life problems. Additionally, the proposed ES is flexible, since it can be tailored according to the investor's risk profile and specific preferences by changing some parameters simply. Moreover, the proposed system is practical, as users can easily understand its structure and they can adjust its parameters conveniently according to their preferences. Furthermore, as stocks can be evaluated through a single process by using relative fundamental ratios, implementation of the proposed ES is convenient.

The proposed expert system is validated for the period between 2002 and 2010, by using the data of 61 stocks that are publicly traded in XU100 and are never left out of ISE during the validation period. The performance of the proposed ES is analyzed in comparison with the benchmark index, XU030, in terms of different risk profiles and investment period lengths. The results reveal that the proposed ES outperforms the benchmark index in terms of all risk profiles. More specifically, the proposed ES performs relatively better in the risk averse investor case than it does in the other cases. Additionally, the performance of the proposed ES is superior relative to the benchmark index in terms of different investment period lengths. More specifically, the performance of the ES is better in the middle term investment periods. In parallel to our expectations, the performance of the ES is relatively higher in risk averse investor and middle term investment period cases.

As the problem dealt in this thesis is quite complex and subjective, and holds high level of uncertainties, there are many opportunities for further studies. Firstly, the macroeconomic factors such as inflation rate, GDP, unemployment rates, etc. that affect stock market are not considered in this study. By taking macroeconomic factors into account, it will be possible to use the proposed ES in international investment case and consequently reduce the systematic risk level of the portfolio. On the other hand, in knowledge acquisition, we can take advantage of the knowledge of multiple experts. In this case, a group decision making approach must be employed. Additionally, in knowledge representation, some possible interactions and conflicts between stock evaluation criteria can be investigated and represented. Moreover, some approaches to represent uncertainty beyond fuzzy approach such as Bayesian statistics and Dempster and Shafer's belief functions can be utilized. Finally, the performance of the rule base can be improved by using an evolutionary algorithm.

REFERENCES

- Badiru, A. B. & Cheung, J. Y. (2002). *Fuzzy engineering expert systems with neural network applications*. John Wiley & Sons.
- Bahrammirzaee, A. (2010). A comparative survey of artificial intelligence applications in finance: artificial neural networks, expert system and hybrid intelligent systems. *Neural Computing & Applications*, 19, 1165–1195.
- Banz, R. W. (1981). The relationship between return and market value of common stocks. *Journal of Financial Economics*, 9(1), 3–18.
- Brabazon, A. & O'Neill M. (2006). *Biologically inspired algorithms for financial modeling*. Springer.
- Brentani, C. (2004). *Portfolio management in practice*. Elsevier.
- Chan, Y. Y., Dillon, T.S. & Saw, E. G. (1989). Port-man - An expert system of portfolio management in banks. In: Pau LF (ed.), *Expert Systems in Economics, Banking and Management*, 87–96.
- Chen, L. H. & Huang L. (2009). Portfolio optimization of equity mutual funds with fuzzy return rates and risks. *Expert Systems with Applications*, 36(2), 3720–3727.
- Durkin, J. (1994). *Expert systems: design and development*. Prentice Hall.
- Edirisinghe, N.C.P. & Zhang, X. (2007). Generalized DEA model of fundamental analysis and its application to portfolio optimization. *Journal of Banking & Finance*, 31, 3311-3335.
- Ehrgott M., Klamroth K. & Schwehm C. (2004). An MCDM approach to portfolio optimization. *European Journal of Operational Research*, 155, 752–770.

- Fama, E. F. & French, K. (1992). The cross section of expected stock returns. *Journal of Finance*, 47(2), 427–465.
- Fasanghari, M., & Montazer, G. A. (2010). Design and implementation of fuzzy expert system for Tehran Stock Exchange portfolio recommendation. *Expert Systems with Applications*, 37, 6138–6147.
- Fernandez, A. & Gomez, S. (2007). Portfolio selection using neural networks. *Computers & Operations Research*, 34, 1177–1191.
- Freitas, F. D., De Souza, A. F. & De Almeida, A. R. (2009). Prediction based portfolio optimization model using neural networks. *Neurocomputing* 72(10–12), 2155–2170.
- Giarratano, J. & Riley, G. (2005). *Expert systems: Principles and programming*. (4th ed.) Thomson Course Technology.
- Goodwin, T. H. (1998). The information ratio. *Financial Analysts Journal*, 54(4), 34-43.
- Grossman, S. J. & Stiglitz, J. E. (1980). On the impossibility of informationally efficient markets. *The American Economic Review*, 70(3), 393-408.
- Hachicha, N., Jarboui, B. & Siarry, P. (2011). A fuzzy logic control using a differential evolution algorithm aimed at modelling the financial market dynamics. *Information Sciences*, 181, 79–91.
- Ho, W. R. J., Tsai, C. L., Tzeng, G. H. & Fang, S. K. (2011). Combined DEMATEL technique with a novel MCDM model for exploring portfolio selection based on CAPM. *Expert Systems with Applications*, 38(1), 16-25.

- Jang, J. S. R., Sun, C. T. & Mizutani, E. (1997). *Neuro-fuzzy and soft computing: A computational approach to learning and machine intelligence*. Prentice Hall.
- Jennings, N.R. & Wooldridge, M.J. (1998). *Agent Technology: Foundations, Applications, and Markets*. Springer.
- Kluger, B. D. & McBride, M. E. (2011). Intraday trading patterns in an intelligent autonomous agent-based stock market. *Journal of Economic Behavior & Organization*, 79(3), 226-245.
- Lee, K. H. (2005). *First course on fuzzy theory and applications*. Springer-Verlag Berlin Heidelberg.
- Maginn, J. L., Tuttle, D. L., McLeavey, D.W. & Pinto, J. E. (2007). *Managing investment portfolios-A dynamic process*. (3rd ed.). John Wiley & Sons, Inc.
- Maringer, D. (2005). *Portfolio management with heuristic optimization*. Springer.
- Markowitz, H. (1952). Portfolio selection. *Journal of Finance*, 7(1), 77-91.
- McGraw, K. L. & Harbison-Briggs, B. K. (1989). *Knowledge acquisition: Principles and Guidelines*. Englewood Cliffs, Prentice Hall.
- Metaxiotis, K., Ergazakis, K., Samouilidis, E. & Psarras, J. (2003). Decision support through knowledge management: the role of the artificial intelligence. *Information Management & Computer Security*, 11 (5), 216 – 221.
- Mogharreban, N. & Zargham, R. (2005). PORSEL: an expert system for assisting in investment analysis and valuation. *Soft Computing - A Fusion of Foundations, Methodologies and Applications*, 9(10), 742–748.

- Nedović, L. & Devedžić V. (2002). Expert systems in finance - a cross-section of the field. *Expert Systems with Applications*, 23(1), 49-66.
- Olsen, R. A. (1998). Behavioral finance and its implications for stock-price volatility. *Financial Analysts Journal*, 54(2), 10–18.
- Quek, C., Yow, K.C., Cheng, P. Y. K. & Tan, C.C. (2009). Investment portfolio balancing: application of a generic self-organizing fuzzy neural network (GenSoFNN). *Intelligent Systems in Accounting*, 16(1/2), 147–164.
- Reilly, F. K. & Brown, K. C. (2004). *Investment analysis and portfolio management*. (7th ed.). South-Western College Publications.
- Romeu, R. & Serajuddin, U. (2001). *Technical analysis for direct access trading*. McGraw-Hill.
- Ross, S. (1976). The arbitrage theory of capital asset pricing. *Journal of Economic Theory*, 13(2), 341–360.
- Ross, T. J. (2004). *Fuzzy logic with engineering applications*. (2nd ed.) John Wiley & Sons Ltd.
- Samaras, G. D., Matsatsinis, N. F. & Zopounidis, C. (2008). A multicriteria DSS for stock evaluation using fundamental analysis. *European Journal of Operational Research*, 187, 1380–1401.
- Sharpe, W. F. (1964). Capital asset prices: A theory of market equilibrium under conditions of risk. *Journal of Finance*, 19(3), 425–442.
- Stockcharts*, (n.d.). 2011, http://stockcharts.com/school/doku.php?id=chart_school:technical_indicators:on_balance_volume

Theforexguide, (n.d.). 2011, <http://www.theforexguide.net/2/Technical-Indicators.pdf>

Turban, E. & Aronson, J. E. (2001). *Decision support systems and intelligent systems*. (6th ed.). Prentice Hall.

Wikipedia, (n.d.). 2011, http://en.wikipedia.org/wiki/Price_to_book_value

Xidonas, P., Askounis D. & Psarras J. (2009). Common stock portfolio selection: a multiple criteria decision making methodology and an application to the Athens Stock Exchange. *Operational Research*, 9(1), 55–79.

Xidonas, P., Ergazakis, E., Ergazakis, K., Metaxiotis, K., Askounis, D., Mavrotas, G. & Psarras, J. (2009). On the selection of equity securities: An expert systems methodology and an application on the Athens Stock Exchange. *Expert Systems with Applications*, 36, 11966–11980.

Xidonas, P., Mavrotas G. & Psarras, J. (2009). A multicriteria methodology for equity selection using financial analysis. *Computers & Operations Research*, 36, 3187-3203.

Xidonas, P. & Psarras, J. (2009). Equity portfolio management within the MCDM frame: a literature review. *International Journal of Banking, Accounting and Finance*, 1 (3), 285-309.

Xidonas, P., Mavrotas, G., Zopounidis, C. & Psarras, J. (2011). IPSSIS: An integrated multicriteria decision support system for equity portfolio construction and selection. *European Journal of Operational Research*, 210(2), 398-409.

APPENDIX A

PERFORMANCE EVALUATION RESULTS FOR THE PROPOSED ES IN CASES OF DIFFERENT RISK PROFILES

A1. Performance Evaluation Results for the Proposed ES in case of Risk Averse Investor

Portfolio No	Stocks	Weights	Investment Period	Compound Return (%)	Avg. Monthly Return (%)	Treynor	Sharpe	Jensen's Alpha (%)	Information Ratio
1	1, 7, 11, 12, 13, 32, 34, 39, 40, 56	0.05, 0.05, 0.05, 0.07, 0.2, 0.08, 0.03, 0.07, 0.2, 0.2	02.01.2002 - 01.07.2002	-22.14	-3.92	-0.0519	-0.5349	0.26	0.4206
2	1, 5, 10, 12, 13, 25, 34, 39, 40, 43, 54, 56	0.2, 0.03, 0.2, 0.07, 0.05, 0.02, 0.03, 0.07, 0.2, 0.02, 0.08, 0.03	01.07.2002 - 02.01.2003	21.05	5.04	0.0363	0.1869	1.69	0.3296
3	4, 6, 8, 34, 35, 54, 56, 58	0.2, 0.2, 0.2, 0.03, 0.05, 0.07, 0.2, 0.05	02.01.2003 - 01.07.2003	6.17	1.92	0.0147	0.1089	0.44	0.1276
4	5, 6, 8, 9, 10, 22, 32, 34, 35, 45, 52	0.03, 0.19, 0.2, 0.05, 0.06, 0.09, 0.08, 0.03, 0.02, 0.2, 0.05	01.07.2003 - 02.01.2004	59.80	8.73	0.0479	0.5286	-3.87	-0.4970
5	1, 5, 7, 8, 13, 34, 35, 50, 59	0.05, 0.03, 0.07, 0.2, 0.2, 0.03, 0.2, 0.2, 0.02	02.01.2004 - 01.07.2004	-7.89	-0.96	-0.0055	-0.0556	-0.64	-0.0696
6	1, 9, 13, 17, 34, 50, 58	0.12, 0.2, 0.2, 0.2, 0.03, 0.2, 0.05	01.07.2004 - 03.01.2005	54.83	7.87	0.0701	1.4664	12.63	0.2204
7	1, 3, 21, 23, 32, 34, 40, 47, 48, 53	0.05, 0.2, 0.2, 0.05, 0.08, 0.03, 0.05, 0.2, 0.07, 0.07	03.01.2005 - 01.07.2005	17.99	3.22	0.0198	0.2308	1.48	0.4776
8	1, 3, 15, 20, 21, 32, 34, 47, 49, 57, 59	0.2, 0.05, 0.02, 0.08, 0.2, 0.08, 0.03, 0.2, 0.07, 0.02, 0.05	01.07.2005 - 02.01.2006	47.03	6.90	0.0816	0.9792	1.11	0.0218
9	1, 3, 9, 13, 15, 17, 21, 41, 58	0.05, 0.2, 0.2, 0.05, 0.05, 0.2, 0.05, 0.05, 0.15	02.01.2006 - 03.07.2006	-7.11	-0.76	-0.0008	-0.0078	0.61	0.2319
10	2, 9, 17, 18, 21, 35, 39, 54, 56	0.07, 0.05, 0.1, 0.2, 0.2, 0.2, 0.07, 0.06, 0.05	03.07.2006 - 04.01.2007	16.46	2.78	0.0665	1.1036	2.14	0.3607
11	4, 8, 13, 15, 17, 56, 58	0.2, 0.2, 0.2, 0.15, 0.1, 0.1, 0.05	04.01.2007 - 02.07.2007	15.50	2.46	0.0241	0.6567	-0.33	-0.2172
12	3, 9, 11, 15, 17, 18, 34, 37, 39, 55	0.2, 0.03, 0.2, 0.05, 0.2, 0.05, 0.03, 0.07, 0.07, 0.1	02.07.2007 - 02.01.2008	20.14	2.93	0.0332	0.3480	0.64	-0.0905
13	3, 10, 17, 21, 27, 37, 39, 44	0.2, 0.2, 0.2, 0.2, 0.02, 0.07, 0.07, 0.04	02.01.2008 - 01.07.2008	-28.53	-4.71	-0.0559	-0.4275	0.43	0.6882
14	2, 3, 4, 8, 17, 21, 28, 56	0.07, 0.15, 0.2, 0.05, 0.18, 0.2, 0.05, 0.1, ...	01.07.2008 - 02.01.2009	-17.81	-2.45	-0.0319	-0.2181	0.79	-0.0665
15	3, 6, 9, 17, 18, 23, 43, 53	0.2, 0.05, 0.05, 0.2, 0.2, 0.2, 0.03, 0.07	02.01.2009 - 01.07.2009	47.12	6.97	0.0986	0.6807	2.98	0.2082
16	1, 3, 7, 9, 13, 16, 45, 55	0.05, 0.2, 0.1, 0.05, 0.2, 0.05, 0.15, 0.2	01.07.2009 - 04.01.2010	73.91	10.69	0.2087	0.8826	7.49	0.3328
17	1, 5, 7, 13, 17, 21, 24, 35, 53	0.2, 0.03, 0.2, 0.2, 0.05, 0.15, 0.05, 0.05, 0.07	04.01.2010 - 01.07.2010	14.86	2.65	0.0435	0.2603	2.04	0.1915
18	1, 5, 7, 13, 17, 21, 24, 53	0.2, 0.03, 0.15, 0.2, 0.1, 0.2, 0.05, 0.07	01.07.2010 - 03.01.2011	34.90	5.38	0.0628	0.8176	2.78	0.4665

A2. Performance Evaluation Results for the Proposed ES in case of Risk Neutral Investor

Portfolio No	Stocks	Weights	Investment Period	Compound Return (%)	Avg. Monthly Return (%)	Treynor	Sharpe	Jensen's Alpha (%)	Information Ratio
1	1, 7, 11, 12, 13, 32, 34, 39, 40, 56	0.05, 0.05, 0.05, 0.07, 0.2, 0.08, 0.03, 0.07, 0.2, 0.2	02.01.2002 - 01.07.2002	-22.14	-3.92	-0.0519	-0.5349	0.26	0.4206
2	1, 5, 6, 10, 12, 25, 34, 39, 40, 56, 59	0.2, 0.03, 0.05, 0.2, 0.07, 0.05, 0.03, 0.07, 0.2, 0.05, 0.05	01.07.2002 - 02.01.2003	17.44	4.43	0.0309	0.1608	1.08	0.2803
3	4, 6, 8, 34, 35, 54, 56, 58	0.2, 0.2, 0.2, 0.03, 0.05, 0.07, 0.2, 0.05	02.01.2003 - 01.07.2003	6.17	1.92	0.0147	0.1089	0.44	0.1276
4	5, 6, 8, 9, 10, 22, 32, 34, 45, 52	0.03, 0.06, 0.2, 0.05, 0.19, 0.11, 0.08, 0.03, 0.2, 0.05	01.07.2003 - 02.01.2004	59.64	8.73	0.0450	0.4965	-4.56	-0.4161
5	1, 5, 7, 8, 13, 34, 35, 50	0.18, 0.03, 0.09, 0.2, 0.2, 0.03, 0.07, 0.2	02.01.2004 - 01.07.2004	-6.79	-0.76	-0.0031	-0.0321	-0.45	-0.0377
6	1, 9, 13, 17, 34, 50, 58	0.12, 0.2, 0.2, 0.2, 0.03, 0.2, 0.05	01.07.2004 - 03.01.2005	54.83	7.87	0.0701	1.4664	12.63	0.2204
7	3, 15, 21, 32, 34, 47, 48, 53, 59	0.2, 0.05, 0.2, 0.08, 0.03, 0.2, 0.12, 0.07, 0.05	03.01.2005 - 01.07.2005	24.29	4.08	0.0260	0.2955	2.31	0.5388
8	1, 3, 15, 20, 21, 32, 34, 47, 49, 59	0.07, 0.18, 0.04, 0.08, 0.2, 0.08, 0.03, 0.2, 0.07, 0.05	01.07.2005 - 02.01.2006	47.00	6.81	0.0933	1.0779	1.80	-0.0015
9	1, 3, 9, 13, 15, 17, 21, 41	0.05, 0.2, 0.2, 0.2, 0.05, 0.2, 0.05, 0.05	02.01.2006 - 03.07.2006	-14.35	-2.11	-0.0167	-0.1535	-0.72	-0.1066
10	1, 2, 9, 17, 18, 21, 35, 39	0.05, 0.07, 0.05, 0.2, 0.2, 0.2, 0.2, 0.03	03.07.2006 - 04.01.2007	16.91	2.78	0.0675	0.9743	2.15	0.3342
11	4, 8, 11, 13, 15, 17, 28, 56,	0.2, 0.2, 0.05, 0.2, 0.2, 0.05, 0.05, 0.05	04.01.2007 - 02.07.2007	15.16	2.37	0.0227	0.6588	-0.45	-0.2977
12	3, 9, 11, 15, 17, 18, 34, 37, 39	0.2, 0.18, 0.2, 0.05, 0.2, 0.05, 0.03, 0.02, 0.07	02.07.2007 - 02.01.2008	19.70	2.93	0.0260	0.2983	0.17	-0.1024
13	3, 10, 17, 21, 27, 37, 39, 44,	0.2, 0.2, 0.2, 0.2, 0.02, 0.07, 0.07, 0.04	02.01.2008 - 01.07.2008	-28.53	-4.71	-0.0559	-0.4275	0.43	0.6882
14	2, 3, 4, 8, 17, 21, 28, 56	0.07, 0.05, 0.2, 0.05, 0.18, 0.2, 0.05, 0.2	01.07.2008 - 02.01.2009	-17.36	-2.36	-0.0302	-0.2081	0.98	-0.0505
15	3, 6, 9, 17, 18, 23, 43, 53	0.2, 0.05, 0.05, 0.2, 0.2, 0.2, 0.03, 0.07	02.01.2009 - 01.07.2009	47.12	6.97	0.0986	0.6807	2.98	0.2082
16	1, 3, 7, 13, 16, 21, 45, 55	0.05, 0.2, 0.05, 0.2, 0.05, 0.05, 0.2, 0.2	01.07.2009 - 04.01.2010	68.71	10.19	0.1856	0.8686	6.73	0.3086
17	1, 5, 7, 13, 17, 21, 24, 35, 53	0.2, 0.03, 0.2, 0.2, 0.05, 0.15, 0.05, 0.05, 0.07	04.01.2010 - 01.07.2010	14.86	2.65	0.0435	0.2603	2.04	0.1915
18	1, 5, 7, 13, 17, 21, 24, 53	0.2, 0.03, 0.2, 0.2, 0.05, 0.2, 0.05, 0.07	01.07.2010 - 03.01.2011	35.53	5.48	0.0648	0.8319	2.90	0.4773

A3. Performance Evaluation Results for the Proposed ES in case of Risk Prone Investor

Portfolio No	Stocks	Weights	Investment Period	Compound Return (%)	Avg. Monthly Return (%)	Treynor	Sharpe	Jensen's Alpha (%)	IR
1	1, 7, 11, 12, 13, 32, 34, 39, 40, 56	0.05, 0.05, 0.05, 0.07, 0.2, 0.08, 0.03, 0.07, 0.2, 0.2	02.01.2002 - 01.07.2002	-22.14	-3.92	-0.0519	-0.5349	0.26	0.4206
2	1, 5, 6, 10, 12, 25, 34, 39, 40, 56, 59	0.2, 0.03, 0.05, 0.2, 0.07, 0.05, 0.03, 0.07, 0.2, 0.05, 0.05	01.07.2002 - 02.01.2003	17.44	4.43	0.0309	0.1608	1.08	0.2803
3	4, 6, 8, 34, 35, 54, 56, 58	0.2, 0.2, 0.2, 0.03, 0.05, 0.07, 0.2, 0.05	02.01.2003 - 01.07.2003	6.17	1.92	0.0147	0.1089	0.44	0.1276
4	5, 6, 8, 9, 10, 22, 32, 34, 43, 45, 52	0.03, 0.05, 0.2, 0.05, 0.2, 0.2, 0.08, 0.03, 0.05, 0.06, 0.05	01.07.2003 - 02.01.2004	58.43	8.55	0.0453	0.4946	-4.36	-0.4482
5	1, 5, 7, 8, 13, 34, 35, 50	0.2, 0.03, 0.09, 0.2, 0.2, 0.03, 0.05, 0.2	02.01.2004 - 01.07.2004	-6.63	-0.73	-0.0028	-0.0286	-0.42	-0.0325
6	1, 9, 13, 17, 34, 50, 58	0.12, 0.2, 0.2, 0.2, 0.03, 0.2, 0.05	01.07.2004 - 03.01.2005	54.83	7.87	0.0701	1.4664	12.63	0.2204
7	3, 15, 21, 32, 34, 47, 48, 53, 59	0.2, 0.05, 0.2, 0.08, 0.03, 0.2, 0.12, 0.07, 0.05	03.01.2005 - 01.07.2005	24.29	4.08	0.0260	0.2955	2.31	0.5388
8	3, 15, 20, 21, 32, 34, 47, 48, 53, 59	0.2, 0.05, 0.07, 0.2, 0.08, 0.03, 0.2, 0.05, 0.07, 0.05	01.07.2005 - 02.01.2006	43.59	6.46	0.0802	0.8784	0.95	-0.0736
9	1, 3, 9, 13, 15, 17, 21, 41	0.2, 0.05, 0.2, 0.2, 0.05, 0.2, 0.05, 0.05	02.01.2006 - 03.07.2006	-16.37	-2.47	-0.0194	-0.1735	-1.03	-0.1552
10	1, 2, 9, 17, 18, 21, 35, 39	0.05, 0.07, 0.05, 0.2, 0.2, 0.2, 0.2, 0.03	03.07.2006 - 04.01.2007	16.91	2.78	0.0675	0.9743	2.15	0.3342
11	4, 8, 9, 11, 13, 15, 17, 28	0.1, 0.2, 0.05, 0.05, 0.2, 0.2, 0.05, 0.15	04.01.2007 - 02.07.2007	12.89	2.03	0.0160	0.4819	-1.23	-0.3936
12	3, 9, 11, 15, 17, 18, 34, 39	0.2, 0.2, 0.2, 0.05, 0.2, 0.05, 0.03, 0.07	02.07.2007 - 02.01.2008	19.24	2.87	0.0243	0.2807	0.02	-0.1155
13	3, 10, 17, 21, 27, 37, 39, 44	0.2, 0.2, 0.2, 0.2, 0.02, 0.07, 0.07, 0.04	02.01.2008 - 01.07.2008	-28.53	-4.71	-0.0559	-0.4275	0.43	0.6882
14	2, 3, 4, 8, 17, 21, 28, 56	0.07, 0.05, 0.2, 0.05, 0.18, 0.2, 0.05, 0.2	01.07.2008 - 02.01.2009	-17.36	-2.36	-0.0302	-0.2081	0.98	-0.0505
15	3, 6, 9, 17, 18, 23, 43, 53	0.2, 0.05, 0.05, 0.2, 0.2, 0.2, 0.03, 0.07	02.01.2009 - 01.07.2009	47.12	6.97	0.0986	0.6807	2.98	0.2082
16	1, 3, 7, 13, 16, 21, 45, 55	0.05, 0.2, 0.05, 0.2, 0.05, 0.05, 0.2, 0.2	01.07.2009 - 04.01.2010	68.71	10.19	0.1856	0.8686	6.73	0.3086
17	1, 5, 7, 13, 17, 21, 24, 35, 53	0.2, 0.03, 0.2, 0.2, 0.05, 0.15, 0.05, 0.05, 0.07	04.01.2010 - 01.07.2010	14.86	2.65	0.0435	0.2603	2.04	0.1915
18	1, 5, 7, 13, 17, 21, 24, 53	0.2, 0.03, 0.2, 0.2, 0.05, 0.2, 0.05, 0.07	01.07.2010 - 03.01.2011	35.53	5.48	0.0648	0.8319	2.90	0.4773

APPENDIX B

PERFORMANCE EVALUATION RESULTS FOR THE PROPOSED ES IN CASES OF DIFFERENT INVESTMENT PERIOD LENGTHS

B1. Performance Evaluation Results for the Proposed ES in case of 3-month Investment Period Length

Portfolio No	Stocks	Weights	Investment Period	Compound Return (%)	Avg. Monthly Return (%)	Treynor	Sharpe	Jensen's Alpha (%)	IR
1	1, 7, 11, 12, 13, 32, 34, 39, 40, 56	0.05, 0.05, 0.05, 0.07, 0.2, 0.08, 0.03, 0.07, 0.2, 0.2	02.01.2002 - 01.04.2002	-14.14	-4.57	-0.0650	-0.5320	-0.68	0.0470
2	1, 10, 12, 23, 25, 39, 40, 43, 44	0.05, 0.05, 0.07, 0.13, 0.03, 0.07, 0.2, 0.2, 0.2	01.04.2002 - 01.07.2002	-21.88	-8.35	-0.0738	-1.7123	-1.77	-1.9367
3	1, 5, 10, 12, 13, 25, 34, 39, 40, 43, 54, 56	0.2, 0.03, 0.2, 0.07, 0.05, 0.02, 0.03, 0.07, 0.2, 0.02, 0.08, 0.03	01.07.2002 - 01.10.2002	4.73	1.63	0.0083	0.0607	2.72	0.4696
4	1, 5, 11, 12, 23, 33, 34, 53, 54, 56, 58	0.05, 0.03, 0.05, 0.07, 0.07, 0.15, 0.03, 0.07, 0.08, 0.2, 0.2	01.10.2002 - 02.01.2003	8.08	5.18	0.0432	0.1605	-2.48	-1.3941
5	4, 6, 8, 34, 35, 54, 56, 58	0.2, 0.2, 0.2, 0.03, 0.05, 0.07, 0.2, 0.05	02.01.2003 - 01.04.2003	-8.25	-2.28	-0.0144	-0.1027	-0.27	-0.0090
6	1, 4, 6, 8, 12, 32, 35, 58	0.05, 0.2, 0.05, 0.2, 0.02, 0.08, 0.2, 0.2	01.04.2003 - 01.07.2003	21.12	7.89	0.0429	0.3045	1.56	0.4586
7	5, 6, 8, 9, 10, 22, 32, 34, 35, 45, 52	0.03, 0.19, 0.2, 0.05, 0.06, 0.09, 0.08, 0.03, 0.02, 0.2, 0.05	01.07.2003 - 01.10.2003	16.06	5.36	0.0228	0.2783	-2.10	-1.1982
8	4, 5, 6, 8, 9, 32, 52, 56, 58	0.2, 0.03, 0.05, 0.15, 0.04, 0.08, 0.05, 0.2, 0.2	01.10.2003 - 02.01.2004	27.31	9.09	0.0505	0.4868	-9.02	-0.7928
9	1, 5, 7, 8, 13, 34, 35, 50, 59	0.05, 0.03, 0.07, 0.2, 0.2, 0.03, 0.2, 0.2, 0.02	02.01.2004 - 01.04.2004	7.65	2.96	0.0293	0.3095	-0.43	0.1442
10	5, 9, 13, 17, 32, 50, 56	0.03, 0.2, 0.2, 0.2, 0.08, 0.09, 0.2	01.04.2004 - 01.07.2004	-11.98	-4.06	-0.0503	-0.6190	-1.41	-0.1199
11	1, 9, 13, 17, 34, 50, 58	0.12, 0.2, 0.2, 0.2, 0.03, 0.2, 0.05	01.07.2004 - 01.10.2004	23.56	7.42	-0.0388	1.5213	16.94	0.0941
12	1, 3, 7, 8, 9, 17, 34, 36, 50	0.2, 0.05, 0.05, 0.05, 0.2, 0.2, 0.03, 0.02, 0.2	01.10.2004 - 03.01.2005	24.02	7.85	-0.0954	1.3212	10.81	0.2574
13	1, 3, 21, 23, 32, 34, 40, 47, 48, 53	0.05, 0.2, 0.2, 0.05, 0.08, 0.03, 0.05, 0.2, 0.07, 0.07	03.01.2005 - 01.04.2005	14.02	4.44	0.0300	0.2996	3.34	2.5283
14	4, 21, 35, 47, 54, 56, 58	0.2, 0.2, 0.02, 0.15, 0.03, 0.2, 0.2	01.04.2005 - 01.07.2005	10.30	3.70	0.0283	0.3315	1.39	0.5778
15	1, 3, 15, 20, 21, 32, 34, 47, 49, 57, 59	0.2, 0.05, 0.02, 0.08, 0.2, 0.08, 0.03, 0.2, 0.07, 0.02, 0.05	01.07.2005 - 03.10.2005	22.24	7.06	0.0331	1.1591	-9.26	-0.1370
16	12, 18, 21, 34, 47, 54, 56, 58	0.07, 0.15, 0.2, 0.03, 0.2, 0.08, 0.2, 0.07	03.10.2005 - 02.01.2006	16.11	5.34	0.0744	0.6109	0.88	-0.1246
17	1, 3, 9, 13, 15, 17, 21, 41, 58	0.05, 0.2, 0.2, 0.05, 0.05, 0.2, 0.05, 0.05, 0.15	02.01.2006 - 03.04.2006	12.70	4.32	0.0680	0.6280	2.41	0.3900

B1. (cont.)

Portfolio No	Stocks	Weights	Investment Period	Compound Return (%)	Avg. Monthly Return (%)	Treynor	Sharpe	Jensen's Alpha (%)	IR
18	1, 3, 7, 9, 13, 17, 21, 41	0.1, 0.15, 0.05, 0.05, 0.2, 0.2, 0.2, 0.05	03.04.2006 - 03.07.2006	-20.92	-7.24	-0.0896	-0.7761	-2.79	-0.1995
19	2, 9, 17, 18, 21, 35, 39, 54, 56	0.07, 0.05, 0.1, 0.2, 0.2, 0.2, 0.07, 0.06, 0.05	03.07.2006 - 02.10.2006	8.91	2.90	0.0229	1.0284	0.87	1.8076
20	2, 4, 18, 21, 28, 32, 33, 34, 35, 56, 58	0.07, 0.2, 0.05, 0.02, 0.05, 0.08, 0.05, 0.03, 0.05, 0.2, 0.2	02.10.2006 - 04.01.2007	4.01	1.45	0.0262	0.3159	0.05	-0.0474
21	4, 8, 13, 15, 17, 56, 58	0.2, 0.2, 0.2, 0.15, 0.1, 0.1, 0.05	04.01.2007 - 02.04.2007	8.89	2.93	0.3056	8.6256	2.54	-0.4259
22	3, 12, 15, 17, 18, 24, 34, 36, 39, 55	0.2, 0.07, 0.2, 0.05, 0.2, 0.05, 0.03, 0.08, 0.07, 0.05	02.04.2007 - 02.07.2007	5.28	1.93	0.0062	0.1838	-2.39	-0.0570
23	3, 9, 11, 15, 17, 18, 34, 37, 39, 55	0.2, 0.03, 0.2, 0.05, 0.2, 0.05, 0.03, 0.07, 0.07, 0.1	02.07.2007 - 01.10.2007	4.22	1.74	0.0014	0.0162	-2.99	-3.4112
24	4, 8, 15, 44, 55, 56, 58	0.2, 0.2, 0.15, 0.05, 0.05, 0.15, 0.2	01.10.2007 - 02.01.2008	-5.37	-1.61	-0.0115	-0.1735	-2.70	-1.3097
25	3, 10, 17, 21, 27, 37, 39, 44	0.2, 0.2, 0.2, 0.2, 0.02, 0.07, 0.07, 0.04	02.01.2008 - 01.04.2008	-18.20	-6.01	-0.0686	-0.4715	2.03	1.3022
26	1, 4, 10, 21, 28, 49, 55, 56	0.05, 0.15, 0.2, 0.2, 0.1, 0.05, 0.05, 0.2	01.04.2008 - 01.07.2008	-18.12	-5.33	-0.0365	-0.2883	-1.24	-0.2991
27	2, 3, 4, 8, 17, 21, 28, 56	0.07, 0.15, 0.2, 0.05, 0.18, 0.2, 0.05, 0.1	01.07.2008 - 03.10.2008	4.31	1.84	0.0272	0.1512	1.49	-0.0489
28	1, 2, 9, 10, 17, 21, 28, 56	0.05, 0.07, 0.05, 0.2, 0.08, 0.2, 0.15, 0.2	03.10.2008 - 02.01.2009	-21.81	-7.42	-0.1050	-0.8784	-1.19	-0.5083
29	3, 6, 9, 17, 18, 23, 43, 53	0.2, 0.05, 0.05, 0.2, 0.2, 0.2, 0.03, 0.07	02.01.2009 - 01.04.2009	2.82	1.12	0.0066	0.0706	2.39	0.5344
30	11, 17, 18, 23, 35, 39, 48, 55	0.2, 0.2, 0.05, 0.05, 0.2, 0.07, 0.03, 0.2	01.04.2009 - 01.07.2009	48.13	14.06	0.1791	1.8213	4.41	0.3051
31	1, 3, 7, 9, 13, 16, 45, 55	0.05, 0.2, 0.1, 0.05, 0.2, 0.05, 0.15, 0.2	01.07.2009 - 01.10.2009	56.12	17.32	-0.1038	1.4747	34.61	0.4395
32	3, 6, 9, 17, 18, 23, 30, 53	0.2, 0.2, 0.05, 0.2, 0.05, 0.2, 0.05, 0.05	01.10.2009 - 04.01.2010	30.30	9.20	0.0822	0.8349	5.00	1.9189
33	1, 5, 7, 13, 17, 21, 24, 35, 53	0.2, 0.03, 0.2, 0.2, 0.05, 0.15, 0.05, 0.05, 0.07	04.01.2010 - 01.04.2010	25.22	8.12	0.3328	0.8236	6.97	0.4056
34	1, 5, 7, 13, 17, 21, 24, 53	0.2, 0.03, 0.05, 0.2, 0.2, 0.2, 0.05, 0.07	01.04.2010 - 01.07.2010	-7.64	-2.27	-0.0155	-0.2462	-1.22	-0.5149
35	1, 5, 7, 13, 17, 21, 24, 53	0.2, 0.03, 0.15, 0.2, 0.1, 0.2, 0.05, 0.07	01.07.2010 - 01.10.2010	18.64	5.90	0.0841	1.2767	1.76	-0.2486
36	1, 7, 13, 17, 21, 24, 32, 53	0.2, 0.2, 0.2, 0.05, 0.15, 0.05, 0.08, 0.07	01.10.2010 - 03.01.2011	17.53	6.12	0.0344	0.5651	6.23	1.0880

B2. Performance Evaluation Results for the Proposed ES in case of 6-month Investment Period Length

Portfolio No	Stocks	Weights	Investment Period	Compound Return (%)	Avg. Monthly Return (%)	Treynor	Sharpe	Jensen's Alpha (%)	IR
1	1, 7, 11, 12, 13, 32, 34, 39, 40, 56	0.05, 0.05, 0.05, 0.07, 0.2, 0.08, 0.03, 0.07, 0.2, 0.2	02.01.2002 - 01.07.2002	-22.14	-3.92	-0.0519	-0.5349	0.26	0.4206
2	1, 5, 10, 12, 13, 25, 34, 39, 40, 43, 54, 56	0.2, 0.03, 0.2, 0.07, 0.05, 0.02, 0.03, 0.07, 0.2, 0.02, 0.08, 0.03	01.07.2002 - 02.01.2003	21.05	5.04	0.0363	0.1869	1.69	0.3296
3	4, 6, 8, 34, 35, 54, 56, 58	0.2, 0.2, 0.2, 0.03, 0.05, 0.07, 0.2, 0.05	02.01.2003 - 01.07.2003	6.17	1.92	0.0147	0.1089	0.44	0.1276
4	5, 6, 8, 9, 10, 22, 32, 34, 35, 45, 52	0.03, 0.19, 0.2, 0.05, 0.06, 0.09, 0.08, 0.03, 0.02, 0.2, 0.05	01.07.2003 - 02.01.2004	59.80	8.73	0.0479	0.5286	-3.87	-0.4970
5	1, 5, 7, 8, 13, 34, 35, 50, 59	0.05, 0.03, 0.07, 0.2, 0.2, 0.03, 0.2, 0.2, 0.02	02.01.2004 - 01.07.2004	-7.89	-0.96	-0.0055	-0.0556	-0.64	-0.0696
6	1, 9, 13, 17, 34, 50, 58	0.12, 0.2, 0.2, 0.2, 0.03, 0.2, 0.05	01.07.2004 - 03.01.2005	54.83	7.87	0.0701	1.4664	12.63	0.2204
7	1, 3, 21, 23, 32, 34, 40, 47, 48, 53	0.05, 0.2, 0.2, 0.05, 0.08, 0.03, 0.05, 0.2, 0.07, 0.07	03.01.2005 - 01.07.2005	17.99	3.22	0.0198	0.2308	1.48	0.4776
8	1, 3, 15, 20, 21, 32, 34, 47, 49, 57, 59	0.2, 0.05, 0.02, 0.08, 0.2, 0.08, 0.03, 0.2, 0.07, 0.02, 0.05	01.07.2005 - 02.01.2006	47.03	6.90	0.0816	0.9792	1.11	0.0218
9	1, 3, 9, 13, 15, 17, 21, 41, 58	0.05, 0.2, 0.2, 0.05, 0.05, 0.2, 0.05, 0.05, 0.15	02.01.2006 - 03.07.2006	-7.11	-0.76	-0.0008	-0.0078	0.61	0.2319
10	2, 9, 17, 18, 21, 35, 39, 54, 56	0.07, 0.05, 0.1, 0.2, 0.2, 0.2, 0.07, 0.06, 0.05	03.07.2006 - 04.01.2007	16.46	2.78	0.0665	1.1036	2.14	0.3607
11	4, 8, 13, 15, 17, 56, 58	0.2, 0.2, 0.2, 0.15, 0.1, 0.1, 0.05	04.01.2007 - 02.07.2007	15.50	2.46	0.0241	0.6567	-0.33	-0.2172
12	3, 9, 11, 15, 17, 18, 34, 37, 39, 55	0.2, 0.03, 0.2, 0.05, 0.2, 0.05, 0.03, 0.07, 0.07, 0.1	02.07.2007 - 02.01.2008	20.14	2.93	0.0332	0.3480	0.64	-0.0905
13	3, 10, 17, 21, 27, 37, 39, 44	0.2, 0.2, 0.2, 0.2, 0.02, 0.07, 0.07, 0.04	02.01.2008 - 01.07.2008	-28.53	-4.71	-0.0559	-0.4275	0.43	0.6882
14	2, 3, 4, 8, 17, 21, 28, 56	0.07, 0.15, 0.2, 0.05, 0.18, 0.2, 0.05, 0.1, , , ,	01.07.2008 - 02.01.2009	-17.81	-2.45	-0.0319	-0.2181	0.79	-0.0665
15	3, 6, 9, 17, 18, 23, 43, 53	0.2, 0.05, 0.05, 0.2, 0.2, 0.2, 0.03, 0.07	02.01.2009 - 01.07.2009	47.12	6.97	0.0986	0.6807	2.98	0.2082
16	1, 3, 7, 9, 13, 16, 45, 55	0.05, 0.2, 0.1, 0.05, 0.2, 0.05, 0.15, 0.2	01.07.2009 - 04.01.2010	73.91	10.69	0.2087	0.8826	7.49	0.3328
17	1, 5, 7, 13, 17, 21, 24, 35, 53	0.2, 0.03, 0.2, 0.2, 0.05, 0.15, 0.05, 0.05, 0.07	04.01.2010 - 01.07.2010	14.86	2.65	0.0435	0.2603	2.04	0.1915
18	1, 5, 7, 13, 17, 21, 24, 53	0.2, 0.03, 0.15, 0.2, 0.1, 0.2, 0.05, 0.07	01.07.2010 - 03.01.2011	34.90	5.38	0.0628	0.8176	2.78	0.4665

B3. Performance Evaluation Results for the Proposed ES in case of 9-month Investment Period Length

Portfolio No	Stocks	Weights	Investment Period	Compound Return (%)	Avg. Monthly Return (%)	Treynor	Sharpe	Jensen's Alpha (%)	IR
1	1, 7, 11, 12, 13, 32, 34, 39, 40, 56	0.05, 0.05, 0.05, 0.07, 0.2, 0.08, 0.03, 0.07, 0.2, 0.2	02.01.2002 - 01.10.2002	-13.08	-1.64	-0.0199	-0.2163	2.23	0.6972
2	1, 5, 11, 12, 23, 33, 34, 53, 54, 56, 58	0.05, 0.03, 0.05, 0.07, 0.07, 0.15, 0.03, 0.07, 0.08, 0.2, 0.2	01.10.2002 - 01.07.2003	15.97	3.02	0.0238	0.1344	-0.59	-0.1543
3	5, 6, 8, 9, 10, 22, 32, 34, 35, 45, 52	0.03, 0.19, 0.2, 0.05, 0.06, 0.09, 0.08, 0.03, 0.02, 0.2, 0.05	01.07.2003 - 01.04.2004	64.30	6.25	0.0403	0.4355	-2.61	-0.5348
4	5, 9, 13, 17, 32, 50, 56	0.03, 0.2, 0.2, 0.2, 0.08, 0.09, 0.2	01.04.2004 - 03.01.2005	26.35	3.25	0.0523	0.4351	1.64	0.0818
5	1, 3, 21, 23, 32, 34, 40, 47, 48, 53	0.05, 0.2, 0.2, 0.05, 0.08, 0.03, 0.05, 0.2, 0.07, 0.07	03.01.2005 - 03.10.2005	38.21	3.93	0.0305	0.3701	0.03	0.0898
6	12, 18, 21, 34, 47, 54, 56, 58	0.07, 0.15, 0.2, 0.03, 0.2, 0.08, 0.2, 0.07	03.10.2005 - 03.07.2006	10.34	1.51	0.0233	0.1954	0.66	0.0995
7	2, 9, 17, 18, 21, 35, 39, 54, 56	0.07, 0.05, 0.1, 0.2, 0.2, 0.2, 0.07, 0.06, 0.05	03.07.2006 - 02.04.2007	20.81	2.30	0.0581	0.9731	1.37	-0.0102
8	3, 12, 15, 17, 18, 24, 34, 36, 39, 55	0.2, 0.07, 0.2, 0.05, 0.2, 0.05, 0.03, 0.08, 0.07, 0.05	02.04.2007 - 02.01.2008	35.43	3.15	0.0245	0.3170	0.23	0.0176
9	3, 10, 17, 21, 27, 37, 39, 44	0.2, 0.2, 0.2, 0.2, 0.02, 0.07, 0.07, 0.04	02.01.2008 - 03.10.2008	-40.35	-4.74	-0.0654	-0.3959	-1.79	-0.0542
10	1, 2, 9, 10, 17, 21, 28, 56	0.05, 0.07, 0.05, 0.2, 0.08, 0.2, 0.15, 0.2	03.10.2008 - 01.07.2009	16.22	2.36	0.0130	0.1040	0.94	0.3573
11	1, 3, 7, 9, 13, 16, 45, 55	0.05, 0.2, 0.1, 0.05, 0.2, 0.05, 0.15, 0.2	01.07.2009 - 01.04.2010	398.77	28.62	1.9862	0.4511	27.92	0.3644
12	1, 5, 7, 13, 17, 21, 24, 53	0.2, 0.03, 0.05, 0.2, 0.2, 0.2, 0.05, 0.07	01.04.2010 - 03.01.2011	23.39	2.70	0.0221	0.3198	0.79	0.2248

B4. Performance Evaluation Results for the Proposed ES in case of 12-month Investment Period Length

Portfolio No	Stocks	Weights	Investment Period	Compound Return (%)	Avg. Monthly Return (%)	Treynor	Sharpe	Jensen's Alpha (%)	IR
1	1, 7, 11, 12, 13, 32, 34, 39, 40, 56	0.05, 0.05, 0.05, 0.07, 0.2, 0.08, 0.03, 0.07, 0.2, 0.2	02.01.2002 - 02.01.2003	-9.66	-0.09	-0.0044	-0.0288	1.14	0.2972
2	4, 6, 8, 34, 35, 54, 56, 58	0.2, 0.2, 0.2, 0.03, 0.05, 0.07, 0.2, 0.05	02.01.2003 - 02.01.2004	65.54	5.16	0.0380	0.3146	-0.51	-0.2265
3	1, 5, 7, 8, 13, 34, 35, 50, 59	0.05, 0.03, 0.07, 0.2, 0.2, 0.03, 0.2, 0.2, 0.02	02.01.2004 - 03.01.2005	60.76	4.26	0.0472	0.5076	1.83	0.2842
4	1, 3, 21, 23, 32, 34, 40, 47, 48, 53	0.05, 0.2, 0.2, 0.05, 0.08, 0.03, 0.05, 0.2, 0.07, 0.07	03.01.2005 - 02.01.2006	75.61	5.03	0.0474	0.5156	0.91	0.1906
5	1, 3, 9, 13, 15, 17, 21, 41, 58	0.05, 0.2, 0.2, 0.05, 0.05, 0.2, 0.05, 0.05, 0.15	02.01.2006 - 04.01.2007	0.51	0.53	0.0130	0.1590	0.53	0.1814
6	4, 8, 13, 15, 17, 56, 58	0.2, 0.2, 0.2, 0.15, 0.1, 0.1, 0.05	04.01.2007 - 02.01.2008	8.41	0.89	0.0047	0.0800	-1.86	-0.7438
7	3, 10, 17, 21, 27, 37, 39, 44	0.2, 0.2, 0.2, 0.2, 0.02, 0.07, 0.07, 0.04	02.01.2008 - 02.01.2009	-51.04	-4.83	-0.0672	-0.4444	-1.17	-0.0060
8	3, 6, 9, 17, 18, 23, 43, 53	0.2, 0.05, 0.05, 0.2, 0.2, 0.2, 0.03, 0.07	02.01.2009 - 04.01.2010	163.97	8.84	0.2083	1.0263	6.17	0.3098
9	1, 5, 7, 13, 17, 21, 24, 35, 53	0.2, 0.03, 0.2, 0.2, 0.05, 0.15, 0.05, 0.05, 0.07	04.01.2010 - 03.01.2011	64.46	4.36	0.0602	0.4875	2.84	0.3131

APPENDIX C
PERFORMANCE EVALUATION RESULTS FOR XU030 IN CASES OF
DIFFERENT INVESTMENT PERIOD LENGTHS

C1. Performance Evaluation Results for XU030 in case of 3-month Investment Period Length

Period No	Investment Period	Compound Return (%)	Avg. Monthly Return (%)	Treynor	Sharpe	Jensen's Alpha (%)
1	02.01.2002 - 01.04.2002	-16.80	-4.80	-0.0548	-0.4912	0.20
2	01.04.2002 - 01.07.2002	-19.82	-7.17	-0.0556	-1.2829	-0.10
3	01.07.2002 - 01.10.2002	-10.22	-2.51	-0.0348	-0.3705	-0.84
4	01.10.2002 - 02.01.2003	15.14	8.14	0.0709	0.2645	0.21
5	02.01.2003 - 01.04.2003	-10.56	-2.24	-0.0103	-0.0749	0.06
6	01.04.2003 - 01.07.2003	11.25	5.20	0.0328	0.2333	0.15
7	01.07.2003 - 01.10.2003	25.29	7.61	0.0491	0.5989	0.98
8	01.10.2003 - 02.01.2004	40.63	13.60	0.1106	1.1062	-0.15
9	02.01.2004 - 01.04.2004	3.45	2.42	0.0270	0.2979	-0.63
10	01.04.2004 - 01.07.2004	-11.58	-3.52	-0.0235	-0.2902	0.74
11	01.07.2004 - 01.10.2004	19.44	6.81	0.0606	2.6216	-0.03
12	01.10.2004 - 03.01.2005	15.91	4.82	0.0438	0.6892	0.20
13	03.01.2005 - 01.04.2005	-0.68	0.74	-0.0051	-0.0508	-0.38
14	01.04.2005 - 01.07.2005	5.08	2.13	0.0188	0.2228	0.22
15	01.07.2005 - 03.10.2005	21.50	7.61	0.0938	3.3755	1.53
16	03.10.2005 - 02.01.2006	14.10	6.03	0.0523	0.4439	-0.96
17	02.01.2006 - 03.04.2006	6.96	2.75	0.0294	0.2756	-0.39
18	03.04.2006 - 03.07.2006	-19.67	-5.91	-0.0495	-0.6391	-0.01
19	03.07.2006 - 02.10.2006	3.95	1.40	0.0154	0.7007	-0.14
20	02.10.2006 - 04.01.2007	3.78	1.62	0.0183	0.2312	-0.78
21	04.01.2007 - 02.04.2007	12.71	3.99	0.0419	1.4771	0.44
22	02.04.2007 - 02.07.2007	7.48	2.31	0.0210	0.7249	0.19
23	02.07.2007 - 01.10.2007	15.64	5.76	0.0393	0.4421	0.61
24	01.10.2007 - 02.01.2008	2.52	1.07	0.0142	0.2224	-0.06
25	02.01.2008 - 01.04.2008	-29.90	-10.96	-0.1022	-0.7207	-0.66
26	01.04.2008 - 01.07.2008	-16.77	-3.89	-0.0340	-0.2684	-0.68
27	01.07.2008 - 03.10.2008	16.35	2.17	0.0240	0.1361	1.57
28	03.10.2008 - 02.01.2009	-19.40	-6.44	-0.0808	-0.6734	1.02
29	02.01.2009 - 01.04.2009	-6.58	-1.92	-0.0224	-0.2967	-0.65
30	01.04.2009 - 01.07.2009	41.46	12.73	0.1100	1.2360	-0.78
31	01.07.2009 - 01.10.2009	28.81	9.23	0.0871	1.3885	-1.13
32	01.10.2009 - 04.01.2010	10.89	3.69	0.0395	0.4125	0.06
33	04.01.2010 - 01.04.2010	5.03	2.46	0.0159	0.1390	-0.48
34	01.04.2010 - 01.07.2010	-5.23	-0.93	-0.0072	-0.1157	-0.11
35	01.07.2010 - 01.10.2010	22.40	6.88	0.0534	0.9968	-0.15
36	01.10.2010 - 03.01.2011	-1.28	-0.84	-0.0157	-0.2945	-1.03

C2. Performance Evaluation Results for XU030 in case of 6-month Investment Period Length

Period No	Investment Period	Compound Return (%)	Avg. Monthly Return (%)	Treynor	Sharpe	Jensen's Alpha (%)
1	02.01.2002 - 01.07.2002	-33.59	-5.99	-0.0551	-0.7203	0.06
2	01.07.2002 - 02.01.2003	5.97	2.81	0.0180	0.0959	-0.33
3	02.01.2003 - 01.07.2003	2.67	1.48	0.0100	0.0762	-0.01
4	01.07.2003 - 02.01.2004	81.98	10.61	0.0816	0.9165	0.60
5	02.01.2004 - 01.07.2004	-8.09	-0.55	-0.0007	-0.0084	-0.27
6	01.07.2004 - 03.01.2005	37.03	5.81	0.0521	1.1631	0.08
7	03.01.2005 - 01.07.2005	5.16	1.43	0.0066	0.0790	-0.10
8	01.07.2005 - 02.01.2006	42.80	6.82	0.0628	0.8170	-0.59
9	02.01.2006 - 03.07.2006	-11.51	-1.58	-0.0087	-0.0905	-0.06
10	03.07.2006 - 04.01.2007	8.29	1.51	0.0169	0.3230	-0.45
11	04.01.2007 - 02.07.2007	20.66	3.15	0.0306	1.1682	0.25
12	02.07.2007 - 02.01.2008	18.86	3.42	0.0264	0.3647	0.25
13	02.01.2008 - 01.07.2008	-38.99	-7.43	-0.0674	-0.5301	-0.59
14	01.07.2008 - 02.01.2009	-11.88	-2.13	-0.0243	-0.1713	1.75
15	02.01.2009 - 01.07.2009	32.95	5.41	0.0439	0.4096	-0.69
16	01.07.2009 - 04.01.2010	42.38	6.46	0.0665	0.8450	-0.16
17	04.01.2010 - 01.07.2010	1.79	0.77	0.0053	0.0624	-0.19
18	01.07.2010 - 03.01.2011	18.96	3.02	0.0193	0.3289	-0.60

C3. Performance Evaluation Results for XU030 in case of 9-month Investment Period Length

Period No	Investment Period	Compound Return (%)	Avg. Monthly Return (%)	Treynor	Sharpe	Jensen's Alpha (%)
1	02.01.2002 - 01.10.2002	-39.02	-4.83	-0.0491	-0.6169	-0.32
2	01.10.2002 - 01.07.2003	20.79	3.70	0.0305	0.1764	0.08
3	01.07.2003 - 01.04.2004	93.88	7.88	0.0621	0.6877	0.05
4	01.04.2004 - 03.01.2005	23.55	2.70	0.0235	0.3280	-0.10
5	03.01.2005 - 03.10.2005	30.98	3.49	0.0313	0.4271	0.10
6	03.10.2005 - 03.07.2006	1.14	0.95	0.0125	0.1200	-0.25
7	03.07.2006 - 02.04.2007	21.70	2.34	0.0235	0.5233	-0.32
8	02.04.2007 - 02.01.2008	29.64	3.05	0.0228	0.3861	0.06
9	02.01.2008 - 03.10.2008	-33.22	-4.23	-0.0340	-0.2449	0.40
10	03.10.2008 - 01.07.2009	7.54	1.46	0.0038	0.0303	0.04
11	01.07.2009 - 01.04.2010	50.81	5.13	0.0483	0.5586	-0.40
12	01.04.2010 - 03.01.2011	12.09	1.70	0.0119	0.1984	-0.26

C4. Performance Evaluation Results for XU030 in case of 12-month Investment Period Length

Period No	Investment Period	Compound Return (%)	Avg. Monthly Return (%)	Treynor	Sharpe	Jensen's Alpha (%)
1	02.01.2002 - 02.01.2003	-28.04	-1.59	-0.0187	-0.1295	-0.15
2	02.01.2003 - 02.01.2004	84.64	6.04	0.0470	0.4078	0.41
3	02.01.2004 - 03.01.2005	28.42	2.63	0.0244	0.3372	-0.23
4	03.01.2005 - 02.01.2006	53.95	4.13	0.0365	0.4488	-0.14
5	02.01.2006 - 04.01.2007	-3.96	-0.04	0.0046	0.0611	-0.19
6	04.01.2007 - 02.01.2008	45.53	3.29	0.0266	0.5122	0.06
7	02.01.2008 - 02.01.2009	-49.43	-4.78	-0.0447	-0.3439	0.68
8	02.01.2009 - 04.01.2010	90.72	5.93	0.0551	0.6141	-0.44
9	04.01.2010 - 03.01.2011	20.39	1.89	0.0128	0.1804	-0.33

APPENDIX D

ABBREVIATIONS

AI:	artificial intelligence
ANN:	artificial neural networks
APT:	arbitrage pricing theory
BB:	Bollinger bands
CAPM:	capital asset pricing model
CCI:	commodity channel index
CR:	current ratio
D/A:	total debt to total assets
D/E:	total debt to total equity
DY:	dividend yield
EBIT:	earnings before interest and taxes
EBT:	earnings before taxes
EMH:	efficient market hypothesis
ES:	expert system
GDP:	gross domestic product
HIS:	hybrid intelligent systems
IA:	intelligent agents
IR:	information ratio
ISE:	Istanbul Stock Exchange
LBB:	lower bound for weight of the stocks with systematic risk less than one
MA:	moving average
MACD :	moving average convergence-divergence
MCDM:	multi-criteria decision making
MF:	membership function
MPT:	modern portfolio theory
MV/BV:	market value to book value
OBV:	on balance volume
P/E:	price to earnings ratio
QR:	quick ratio
RFR:	risk-free rate of return
ROC:	rate of change momentum
ROE:	return on equity
RS:	relative strength
RSI:	relative strength index
SMA:	simple moving average
SP500:	Standard & Poor's 500 index
TSK:	Takagi-Sugeno inference technique
XU030:	Istanbul Stock Exchange National 30 Index
XU100:	Istanbul Stock Exchange National 100 Index
β :	systematic risk