

**DOKUZ EYLÜL UNIVERSITY
GRADUATE SCHOOL OF NATURAL AND APPLIED
SCIENCES**

**DEVELOPMENT AND ANALYSIS OF PORT
INFORMATION TECHNOLOGIES FOR
LOGISTICS SERVICES EFFICIENCY: PORT OF
İZMİR CASE**

by
Türkay YILDIZ

June, 2011
İZMİR

**DEVELOPMENT AND ANALYSIS OF PORT
INFORMATION TECHNOLOGIES FOR
LOGISTICS SERVICES EFFICIENCY: PORT OF
İZMİR CASE**

**A Thesis Submitted to the
Graduate School and Applied Sciences of Dokuz Eylül University
In Partial Fulfillment of the Requirements for
the Degree of Doctor of Philosophy in
Coastal Engineering, Marine Sciences and Technology**

**by
Türkey YILDIZ**

**June, 2011
İZMİR**

Ph.D. THESIS EXAMINATION RESULT FORM

We have read the thesis entitled “**DEVELOPMENT AND ANALYSIS OF PORT INFORMATION TECHNOLOGIES FOR LOGISTICS SERVICES EFFICIENCY: PORT OF İZMİR CASE**” completed by **TÜRKAY YILDIZ** under supervision of **PROF. DR. FUNDA YERCAN** and we certify that in our opinion it is fully adequate, in scope and in quality, as a thesis for the degree of Doctor of Philosophy.



Prof. Dr. Funda Yercan

Supervisor

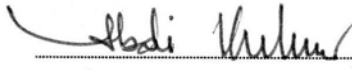

Prof. Dr. Abdi Kılıç

Thesis Committee Member



Prof. Dr. Erdem Özal

Thesis Committee Member

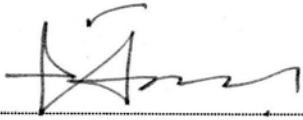

Doç. Dr. Gözdeniz Hecer

Examining Committee Member



Yrd. Doç. Dr. Zeynep

Examining Committee Member

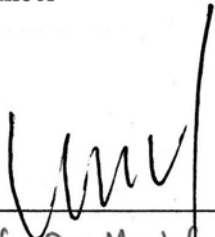

Prof. Dr. Mustafa SABUNCU
Director

Graduate School of Natural and Applied Sciences

ACKNOWLEDGEMENTS

I would like to express my gratitude to my advisor Prof. Dr. Funda Yercan for her support and guidance during my Ph.D. education. I feel fortunate to work with her. I am also grateful to the other members of thesis committee.

I could not have achieved without the support of my family. Without their enduring support, none of this would have been possible. I can not achieve Ph.D. without all of you.

June 2011

Türkay YILDIZ

**DEVELOPMENT AND ANALYSIS OF PORT INFORMATION
TECHNOLOGIES FOR LOGISTICS SERVICES EFFICIENCY: PORT OF
İZMİR CASE**

ABSTRACT

The literature about seaport operations emphasizes the fact that numbers of resources utilized at seaport terminals add multitude of complexities to optimization problems. In such dynamic environments, there has been a need for solving each complex operational problem to increase service efficiency and to improve effectiveness of seaport's IT services and thus seaport's competitiveness. By implementing optimal solutions and putting into practice of heuristic methods, multitude of operational problems can be solved. Computational results reveal that applied methods are efficient, versatile, and easy to use in solving problems. As an outcome, this thesis offers mathematical and process models, high performing optimization algorithms, and optimization solutions for container terminal operations. In addition, the thesis states key seaport logistics problems and propose innovative algorithms for solving complex combinatorial seaport logistics problems. Computational results present that the proposed algorithms are efficient, convenient, and applicable stochastic methods for solving optimization problems of seaport logistics operations. Additionally, because of the wide applicability of seaport operational research solutions, the thesis not only specifically proposes solutions for İzmir seaport, but also presents solutions for wide range of global seaports operations.

Keywords : genetic algorithm, cross entropy algorithm, seaport terminal, logistics, metaheuristic, optimization, stochastic method

LOJİSTİK HİZMETLERİ VERİMLİLİĞİ İÇİN LİMAN BİLGİ TEKNOLOJİLERİNİN GELİŞTİRİLMESİ VE ANALİZİ: İZMİR LİMANI ÖRNEĞİ

ÖZ

Liman faaliyetleri ile ilgili literatür, limanlardaki operasyonel kaynakların sayısının artışı ile birlikte optimizasyon problemlerinin karmaşıklık seviyesinde de hızlı bir artışa neden olduğunu vurgulamaktadır. Bu tür dinamik ortamlarda, hizmet verimliliğini, rekabetçi yapıyı ve bilgi teknolojileri etkinliğini artırmak için her zaman, her bir karmaşık problemin çözümüne ihtiyaç duyulmaktadır. Optimal çözümleri devreye almak ve sezgisel metodları pratik kullanıma kazandırmak ile birlikte çok sayıda operasyonel problemin çözümü mümkün olabilmektedir. Bu tezde liman faaliyetleri verimliliği için, matematiksel modeller, süreç modelleri ve yüksek performanslı algoritmalar sunulmaktadır. Sayısal hesaplamalar ve sonuçlar sunulan unsurların verimli, kullanışlı ve uygulanabilir olduğunu göstermektedir. Tezde sunulan çalışma sadece İzmir limanı ile sınırlı olmayıp, dünya üzerindeki tüm liman operasyonları için geçerlilik arz etmektedir.

Anahtar sözcükler : genetik algoritma, cross entropy algoritması, deniz limanları, lojistik, sezgisel metodlar, optimizyon, istatistiksel metod

CONTENTS

	Page
Ph.D. THESIS EXAMINATION RESULT FORM	ii
ACKNOWLEDGEMENTS	iii
ABSTRACT.....	iv
ÖZ	v
CHAPTER ONE – INTRODUCTION	1
1.1 Logistics and Seaport Terminal Operations.....	1
1.2 The Reason for a Research on Container Terminal: Motivation & Scope	2
1.3 The Structure of the Thesis	3
CHAPTER TWO – BACKGROUND: SEAPORT LOGISTICS INDUSTRY	5
2.1 Logistics and Seaport Terminal Operations.....	5
CHAPTER THREE – LITERATURE REVIEW	11
3.1 Seaport Logistics Operations Review	11
3.2 Optimization Needs at Seaport Terminal.....	15
3.3 A Background: Combinatorial Optimization and Heuristic Algorithms	16
CHAPTER FOUR – DEVELOPMENT OF MODELS.....	19
4.1 Seaport Terminal Problems and Mathematical Models.....	19
4.1.1 Quay Crane/Yard Crane Scheduling.....	19
4.1.2 Generalized Assignment Problem (GAP).....	21
4.1.3 Scheduling (Employees, Stevedore, etc.).....	22
4.1.4 Routing Problem at Seaport Terminals	22
4.1.5 Hinterland and Landside Operations (Routing Problem).....	23
4.1.6 Sheltering, Storage, Warehousing Operations – Layout Design.....	25
4.1.7 Intermodal Connections and Scheduling	26

CHAPTER FIVE – SOLUTIONS TO SEAPORT PROBLEMS 28

5.1 Shortest Distance Problems 28

 5.1.1 The Cross Entropy (CE) Method 28

 5.1.2 Applying the Cross Entropy (CE) Method – Shortest Path Problem..... 33

 5.1.3 About the CE Method 42

5.2 Solutions to Trailer Routing Problems..... 44

 5.2.1 Problem Statement 45

 5.2.2 Genetic Algorithm (GA) 50

 5.2.3 Various Scenarios and Network Configurations 52

 5.2.4 About Optimal Solutions by Heuristics Methods 61

5.3 Quay Crane Operation Characteristics..... 63

 5.3.1 Quay Crane Characteristics..... 65

 5.3.2 Quay Crane Characteristics and Processes 68

5.4 Storage Yard Operations and Simulation..... 75

 5.4.1 Trailer and Intermodal Area Operations 78

 5.4.2 Generalized Yard Operations Model and Solutions 82

5.5 Vehicle Dispatching and Assignment Problem..... 91

 5.5.1 General Assignment Problem: Concepts 92

 5.5.2 Solutions to Assignment Problems 94

 5.5.3 Assignment Problems at Container Terminals..... 97

**CHAPTER SIX – LOGISTICAL PERFORMANCE INDICATORS:
DEVELOPMENT OF HYPOTHESES, ANALYSIS AND TESTINGS..... 105**

6.1 Hypotheses 105

6.2 Analysis and Testing of the Hypotheses 109

6.3 Hypotheses Results 144

CHAPTER SEVEN – CONCLUSIONS AND DISCUSSIONS 146

7.1 About Findings..... 147

7.2 Future Outlook and Discussions	148
REFERENCES.....	151
APPENDICES.....	166
APPENDIX A	166
APPENDIX B	171
APPENDIX C	177

CHAPTER ONE

INTRODUCTION

1.1 Logistics and Seaport Terminal Operations

Logistics is the sum of all activities that, when arranged in the proper order, pertain to all aspects of the manufacturing and distribution process to ensure the delivery of the right products to the right markets at the right time. According to Hesse (2008), logistics activities aim to deliver consignments in the right composition (i.e., in terms of quantity and quality), at the precise time and at the lowest possible cost. Additionally, it requires physical activity and infrastructure, particularly the transfer of commodity shipments by truck, rail, airplane, or ship, as well as the handling of consignments in warehouses, distribution centers, and parcel stations and the delivery of shipments to the final point of consumption (Hesse 2008).

In terms of logistics activities and strategies, with respect to the improved competitiveness, *seaport logistics operations* (see figure 1.1) possess characteristics that are similar to supply chains and other logistics systems. However, seaport logistics operations are constrained by tight space layouts and some exceptional handling equipment that supplies sizeable numbers of containers and/or bulk cargo traffic with increasing demands for superior logistics service.

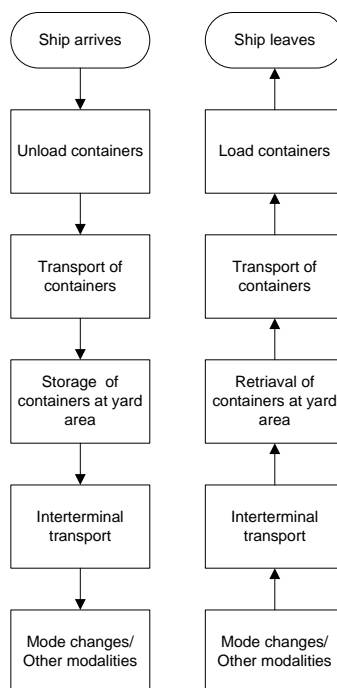

Figure 1.1 General overview of container terminal load/unload processes.

1.2 The Reason for a Research on Container Terminals : Motivation & Scope

The spatial organization of economic activity has been fundamentally transformed over recent decades in response to structural changes, new technologies and, particularly, globalization: the expansion of world trade, manufacturing, and goods distribution around the globe (Hesse 2008).

According to Hesse (2008), globalization has brought about important developments and significant changes at seaport logistics terminals. The competitive environment of the seaport and maritime sector is changing at an ever-increasing pace. According to Steenken et al. (2007), in terms of being an essential part of a unit-load-concept, the importance of the container has achieved clear significance in international sea freight transportation in last 40 years. As the volume of cargo traffic has intensified with the increasing global production, these changes, as noted by Verhetsel and Sel (2009), have triggered improved maritime and port access and service level needs.

By considering the competitive environment of seaport and maritime sector, this thesis presents formulations and methodologies for a series of problems to form a virtual Izmir (Turkey) seaport of logistic terminal and the study proposes innovative methods and techniques to solving the complex operational problems of a seaport terminal. In this study, seaport problems are defined and classified into functional areas, such as scheduling, assignment, routing, layout design, etc. Then, high performing and cutting-edge methods are proposed for solving complex combinatorial problems.

The significance of this study is three-fold. Firstly, this thesis provides up-to-date literature background, about not only the current state-of-the-art methods, techniques and applications, but also provides background information about logistics systems' industrial positioning and the outlook of the sector.

Secondly, in this study, specific operational seaport problems are modeled. Innovative and high performing optimization methods and algorithms are brought into the scene. The problems are exemplified and the proposed methods are utilized to achieve optimal and the best possible solution. Thus, the generated solutions along with the methods have the highest potential to be applied into the real world scenarios by making the necessary modifications and adaptations.

Thirdly, this study enhances the research about the seaport logistics terminals and allows for the development of further research questions in this area. In addition, the applicability of this research in real-world cases is high and the knowledge gained from this study will have a direct impact on the field.

1.3 Structure of the Thesis

A brief background and a brief motivation for the research have been given in this chapter one. The chapter two introduces the general background about seaport logistics industry. The next chapter, the chapter three, provides general literature

background about seaport logistics operations, optimization issues, and algorithms. The fourth chapter deals with the pure base operational problems and briefly introduces mathematical models about container terminal operations. The fifth chapter introduces the innovative and high performing cross entropy (CE) algorithm method for the first time for use in the solution of container terminal operational problems. Then, in the same chapter, container vehicle routing problems are modeled and various solutions based on the given scenarios are investigated. Quay crane processes characteristics are examined to facilitate realistic visualization of simulations about container loading and unloading operations at the berth area of a container terminal. Besides, storage yard operations are considered and, solutions with different methodological approaches are provided to achieve optimal service levels for the operations of yard vehicles. In addition, an important problem of terminal vehicle dispatching and assignment problems are solved with the introduction and implementation of algorithms, thus solutions lead to optimal client/server assignment strategies for yard operations. Several hypotheses are developed, analyzed and tested in chapter six and the concluding remarks and discussions are provided at final chapter seven.

CHAPTER TWO

BACKGROUND: SEAPORT LOGISTICS INDUSTRY

In this chapter, brief background information along with the literature about seaport logistics industry is presented. The past and the current outlook of the seaport terminal operations are reviewed shortly. Additionally, some statistical figures about the trend in container terminal industry are given. Finally, the sources of liner schedule unreliability are given within the emphasis on the causes of terminal operations disturbances issues.

2.1 Logistics and Seaport Terminal Operations

The numbers of seaport container terminals and competition among them have become noteworthy with an increasing containerization. (See fig. 2.1 and 2.2) Thus, operations now are unthinkable without effective and efficient use of information technology as well as appropriate optimization (operations research - OR) methods. Container terminals are physical links between sea and land transport modes and container terminals are key locations for supporting the global trade volume. Thus, it is a major component of containerization system (Dowd and Leschine, 1990). Based on the increased trade volumes in a global scale, port authorities are under pressure to improve port service efficiencies to meet the increasing demand and by ensuring that port services are provided on an increasingly competitive basis (Sharma and Yu, 2009).

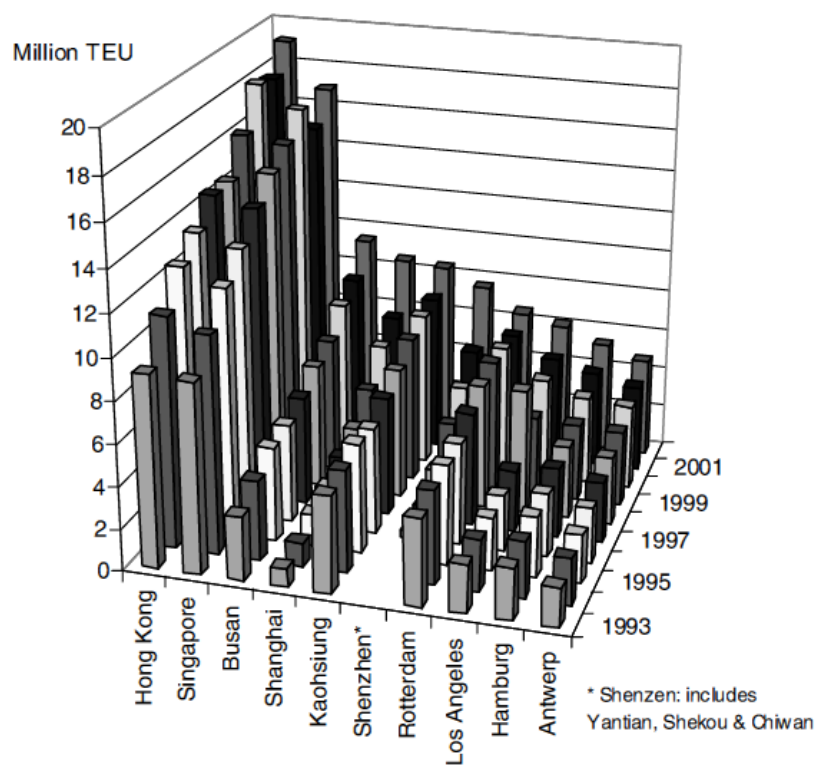

Figure 2.1 Container turnovers – The top ten largest container terminals of the world (adopted from Steenken et al, 2007)

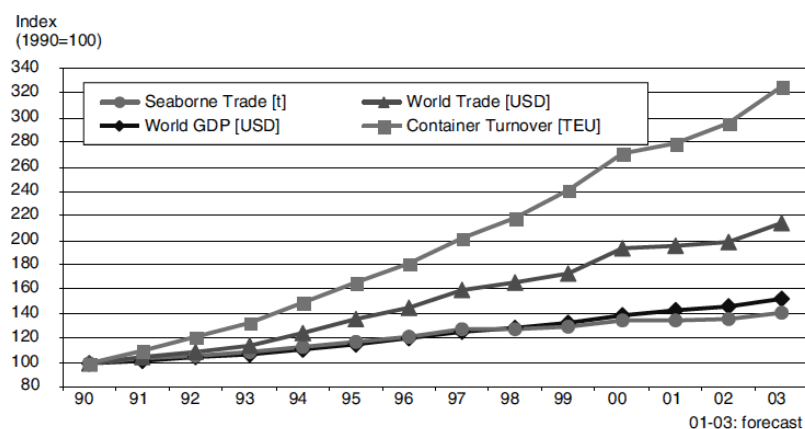

Figure 2.2 Containerization trend: High growth of container turnover (Source: Steenken et al, 2007)

Since 1980, the total international maritime trade has increased by 67% in terms of weight. Tanker cargo has increased modestly, but dry bulk cargo has increased by 85%. The “Other” dry cargo, which consists of general cargo (including

containerized cargo) and minor dry bulk commodities, has more than doubled. (Christiansen et al, 2007) See figure 2.3 below.

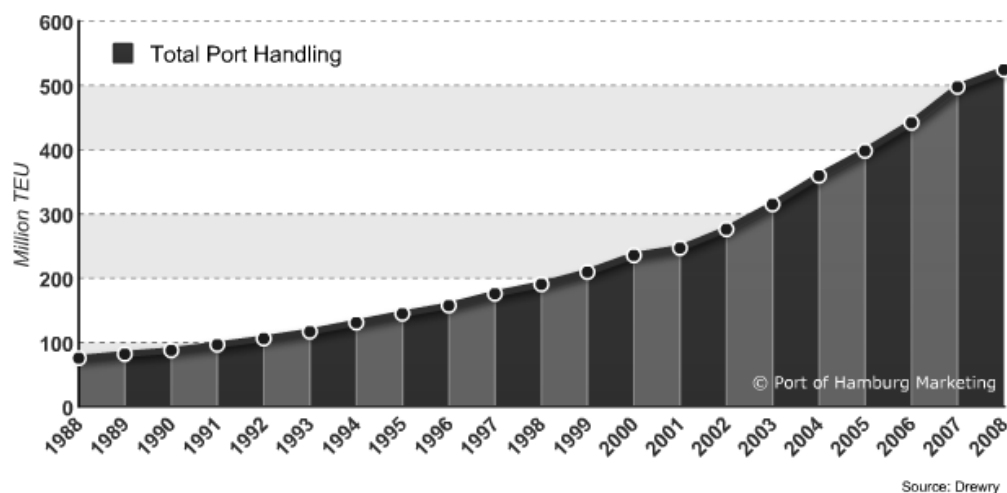

Figure 2.3 Worldwide Container Handling. (Source: <http://www.hafen-hamburg.de/node/1304>)

	1982	2007
Number of all ships > 100 GT	75,151	97,504
Number of ships 100 GT–499 GT	37,617	45,966
Number of all ships > 500 GT	37,534	51,538
Average tonnage of all ships > 100 GT	5,652	7,948
Average tonnage of ships > 500 GT	11,066	14,306

Source for 2007 data: Lloyd's Register – Fairplay, World Fleet Statistics 2007

	1958	1982
Number of all ships > 100 GT	35,202	75,151
Number of ships 100 GT–499GT	13,278	37,617
Number of all ships > 500 GT	21,924	37,534
Average GT of all ships > 100 GT	3,353	5,652
Average GT of ships > 500GT	5,231	11,066

Source: Lloyd's Register of Shipping, Notes on Statistical Tables 1982

Figure 2.4 Development of the world merchant fleet. (Source: Mansell, 2009)

The world maritime fleet has grown in parallel with the seaborne trade (See fig. 2.4 and fig. 2.5). The cargo carrying capacity of the world fleet has reached 857 million tons at the end of 2003, an increase of 25% over 1980 (Christiansen et al, 2007).

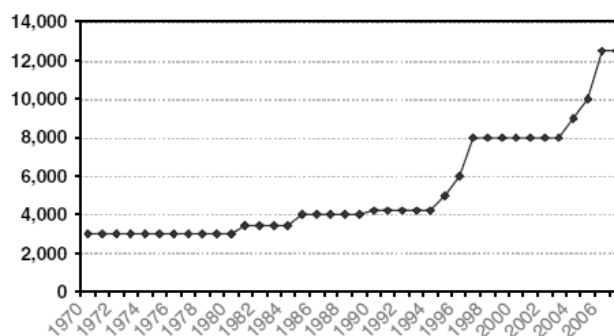

Figure 2.5 Largest available ship - TEU slot capacity in TEU (Source: Notteboom, 2009)

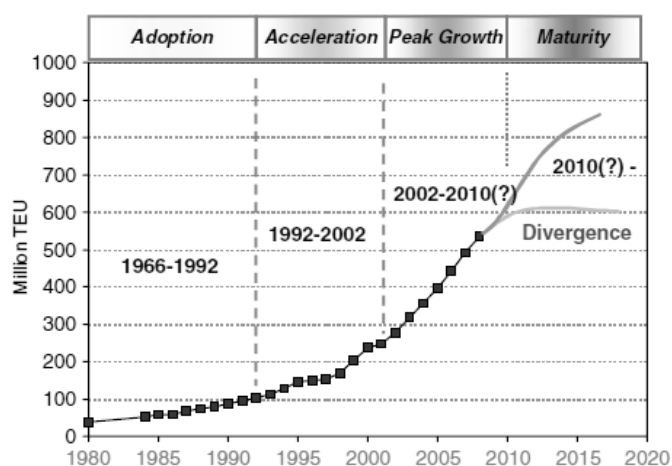
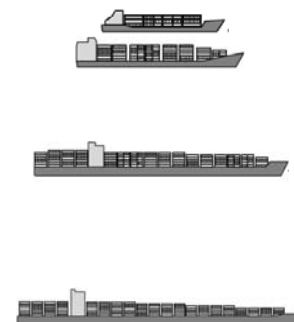

Figure 2.6 World container traffic 1980-2008 (Source: Notteboom, 2009)

Container-related transportation activities have grown remarkably over the last 10 years and the trend does not show any sign of slowing down as illustrated by the annual world container-traffic figures (see fig. 2.6), in millions of TEUs (20 feet equivalent container units). Containerized intermodal transportation supports a significant part of the international movement of goods (Crainic and Kim, 2007). See the table 2.1 below.

Table 2.1 Vessel size and capacity by generation. (Source: Meisel, 2009; Brinkmann, 2005)

Generation	Capacity (TEU)	Length (m)	Beam (m)	Draft (m)
-	<760	<120	<16	<8
1	760-1000	120-190	16-28	8-10
2	2000-2800	210-240	28	11.5
3	3000-4000	260-290	32.2	12.5
4	4000-5000	280-295	32.2	13.5
5	5000-6000	285-318	39.2-40.8	13.5
6	6000-6400	295-318	40.0-42.8	14.2
7	6400-7500	318-348	42.8-45.0	14.8-15.0
8	7500-8400	348-365	48	14.8-15.2



Recent years, the top 20 seaport terminals in the world have shown about 15% increase in demand and about 86% percent of seaport terminal operations have been reported by Notteboom (2006) as terminal operations disturbances. (See Fig. 2.7) About 21% of this figure accounts for port/terminal productivity below expectations and 65% of the figure is reported as unexpected waiting times before berthing and waiting before charge/discharge operations. Therefore, achieving optimum and quick solutions to the problems of seaport logistics operations are crucial for an improved logistics service output.

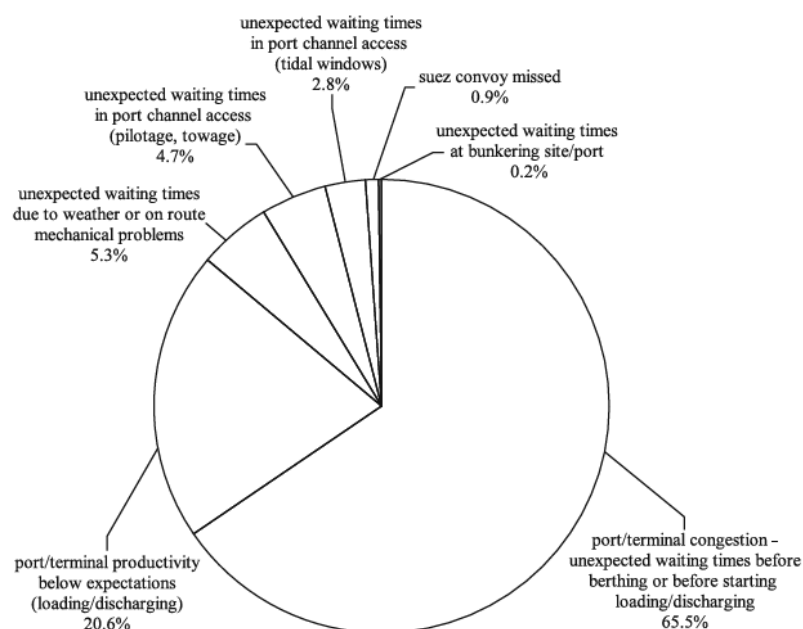

Figure 2.7 Sources of liner schedule unreliability - Survey data of East Asia – Europe relations (Source: Notteboom, 2006)

In this chapter, it is stated particularly with a detail that world maritime fleet has a great potential of growth over the next coming years and thus the demand for superior terminal operations and handling facilities is high in a globally competitive environment. Intense container traffic along with the harsh competitive environment puts the effective and efficient terminal service management at utmost important list of terminal service operators.

In the next chapter, a comprehensive literature review is made about seaport logistics operations. Then, optimization needs at seaport terminal operations are emphasized along with a literature background. In addition to the review, heuristic methods with continuous and discrete variables are also introduced.

CHAPTER THREE

LITERATURE REVIEW

This chapter provides a comprehensive literature review about seaport logistics operations. Container loading and unloading operation workflows are depicted to help readers to visualize the actual events taking place at seaport terminals. Then, the concepts of optimization and heuristic methods are given with key references from the literature. Additionally, key references to the comprehensive studies of discrete and continuous variables of algorithms are also presented.

3.1 Seaport Logistics Operations Review

In the literature, seaport logistics operations are divided mainly into three sections: seaside, yard, and landside operations. Each of these operations engages multiple joined processes, such as loading and unloading processes. Main functions of container terminals (Murty et al, 2005) can be divided into two categories. Briefly, loading/unloading containers from vessels and temporarily storing containers before they are picked for movement to their final destinations. See figure 3.1 and figure 3.2.

Three main types of handling operations are performed in a container terminal (Crainic et al, 2007):

- (1) ship operations associated with berthing, loading, and unloading container ships,
- (2) receiving/delivery operations for outside trucks and trains, and
- (3) container handling and storage operations in the yard.

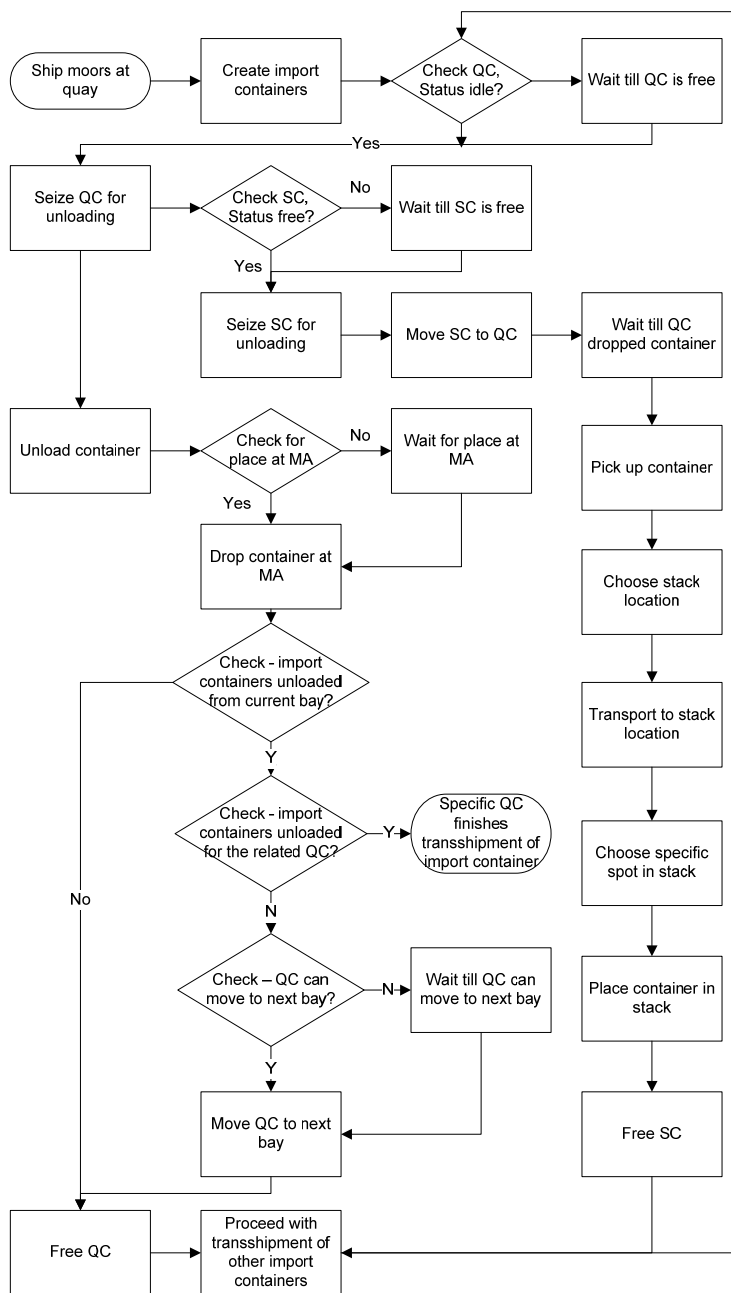

Figure 3.1 Overview model of unloading process - Adapted and modified from Vis and Anholt (2010).

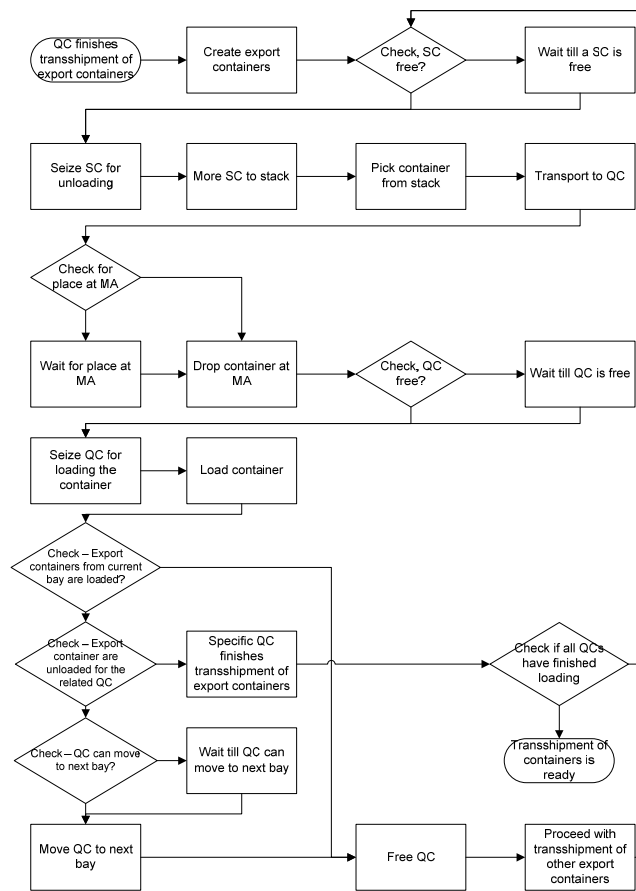

Figure 3.2 Overview model of loading process - Adapted and modified from Vis and Anholt (2010).

When a ship arrives at the container port terminal, it is assigned a berth and a number of quay cranes. Berth space is a very important resource in a container terminal (construction costs to increase capacity are very high, even when space for growth exists) and berth scheduling determines the berthing time and position of a container ship at a given quay (Crainic et al, 2007). Then, the import containers have to be taken off the ship. Quay Cranes (QCs), which take the containers off the ship's hold or off the deck do this (Vis and Koster, 2003).

On the landside, the receiving and delivery operations provide the interface between the container terminal activities and the external movements. A receiving operation starts when containers arrive at the gate of the terminal carried by one or several outside trucks or a train (Crainic and Kim, 2007). Next, the containers are transferred from the QCs to vehicles that travel between the ship and the stack. This

stack consists of a number of lanes, where containers can be stored for a certain period. The lanes are served by systems like cranes or straddle carriers (SCs). A straddle carrier can both transport containers and store them in the stack. It is also possible to use dedicated vehicles to transport containers. If a vehicle arrives at the stack, it puts the load down or the stack crane takes the container off the vehicle and stores it in the stack. After a certain period, the containers are retrieved from the stack by cranes and transported by vehicles to transportation modes like barges, deep-sea ships, trucks, or trains. This process can also be executed in reverse order, to load export containers onto a ship (Vis and Koster, 2003).

The sea and landside operations interact with the yard container handling and storage operation through the information on where the containers are or must be stacked within the yard. How containers are stored in the yard is one of the important factors that affect the turn-around time of ships and land vehicles. The space-allocation problem is concerned with determining storage locations for containers either individually or as a group (Crainic and Kim, 2007).

Within these processes, in order to have an efficient logistics service output, there exist strategic and operational bodies that vigorously necessitate optimal resource management solutions based on the changing parameters of the operating conditions. General optimization needs at seaport terminals are arranged mainly as, berth allocation, crane assignment, crane scheduling, yard management, yard traffic management, workforce planning, sheltering/warehousing, hinterland operations, and infrastructure connections i.e. intermodal connections. In this thesis, all three sections of seaport terminal operations are examined.

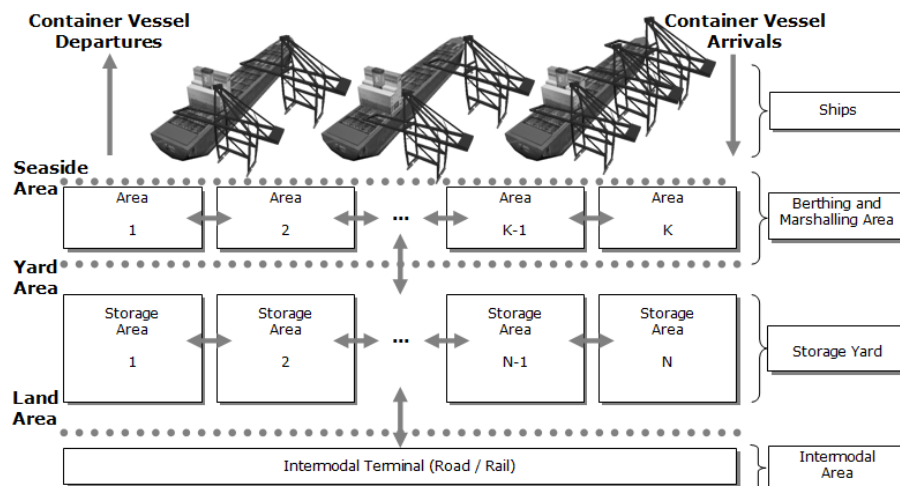

Figure 3.3 Divisions of seaport logistics operations

3.2 Optimization Needs at Seaport Terminal

Problems arising in a container terminal that draw the attention for a quantitative analysis (Caramia and Dell'Olmo, 2008):

- *Design problems* that account for the determination of, e.g., the handling equipment in the yard, the number of berths, quay cranes, yard cranes, storage areas, and human workforce.
- *Operational planning problems*; because of the scarce resource availability in the terminal (e.g., limited number of berths, quay cranes, yard cranes, yard space, and human workforce), scheduling the handling operations in container terminals has to be carried out in order to maximize the efficiency of the operations, preventing possibly costly conflicts among jobs.
- *Real-time control problems*; even if resource allocation, for resources like berths, quay cranes, and storage areas, is carried out in a planning phase preceding the usage of the resources themselves, it can happen that adjustments have to be executed in real time, especially in the case of short-term planning

One of the most important challenges in systems optimization is the reliability and the performance of the algorithm. In dynamically managed terminal operations, (e.g.

Automated Guided Vehicles (AGVs), and Automated Straddle Carriers (ASCs)), instant decisions play crucial roles in overall terminal operations (Lokuge and Alahakoon, 2004; 2007; Van Hee and Wijbrands, 1998; Liu et al, 2002; Rashidi, 2006). On the other side, at dynamically changing operating environments, such as in additional amounts of vessels waiting for service at the queue and intensified container traffic at the yard area, the computing time required for specific decisions should not go beyond a feasible time range set by as a default. Dynamically routing yard trailers to particular locations require highly organized terminal systems. Optimization of these operations involve sophisticated planning of input and output parameters and stating the optimization problems, thus, leading a way to a much complicated and long optimization problem definitions with more constraints and variables. In such situations, algorithm performance and its global search within the overall conditions for optimal values is highly important.

Some combinatorial optimization problems are NP-hard (Garey and Johnson, 1979). When $P \neq NP$ then there is no polynomial time algorithm for these kinds of problems. Thus, many efforts have been devoted by the researches to tackle with these problems. Metaheuristics (i.e. the CE) is systematic approach to obtain knowledge from during the search process of an algorithm. Therefore, algorithm provides better knowledge for the future search of a better solution.

3.3 A Background: Combinatorial Optimization and Heuristic Algorithms

A combinatorial optimization problem can be written as

$$x^* = \min_{x \in D \subseteq X} f(x), \quad (1)$$

where the objective is to find $x^* \in D \subseteq X$. X is bounded by a finite space and $D \subseteq X$ is the subspace of feasible solutions. $f : X \rightarrow R^1$ is the objective function.

To obtain solutions for the types of problems, as shown (1), there exist several approaches (Aarts and Korst, 1989; Colorni et al, 1996; Dorigo et al, 1999; Goldberg, 1989; Kim et al, 2004; Kim 2005; Kozan and Preston, 1999; Lee and

Chen, 2008; Lee et al, 2005; Legato and Mazza, 2001) and depending on the type of solution, there are in a characteristic manner three main types of algorithms: Exact, Heuristic, and Approximate (Sergienko I.V. et. al, 2009).

- The return of the optimal solution in a finite space is assured in exact algorithms. If the algorithm cannot solve the problem, an optimal solution will not present. On the other hand, exact algorithms cannot constantly be used to solve some variations of CO problems (e.g. at dynamic problems and problems with lack of clarity).
- Heuristic algorithms in many cases can provide one of a kind way of obtaining an optimal solution in a reasonable period and they are usually algorithms with absent or unknown accuracy estimates.
- Approximate algorithms (evolutionary algorithms, swarm algorithms, stochastic local search, etc.) are often based on some heuristics and if exists these algorithms return a substitute solution in a finite time and the preciseness of these solutions can be estimated.

Briefly, evolutionary algorithms originate from the biological evolution, such as, the Genetic Algorithm (GA), Memetic Algorithm (MA), etc. Swarm intelligence algorithms take advantage of a special technique used for the identification of the local interaction of scent or swarms, such as at Ant Colony Optimization (ACO), Particle Swarm Optimization (PSO), etc. Stochastic local search algorithms approach, such as Simulated Annealing (SA), exploits the development of a local search and then it employs the best solution from the neighborhood along with the worst value of the objective function.

Based on the type of decision variables, the most remarkable network design problems can be divided into discrete and continuous models (Gallo et al, 2010, Beltran et al, 2009):

- Continuous variable models were developed and formulated in papers by Dantzig et al (1979), Abdulaal and Le Blanc (1979), Marcotte (1983), Harker and Friesz (1984), Le Blanc and Boyce (1986), Suwansirikul et al (1987), Friesz et al (1992), Davis (1994), Cho and Lo (1999), Meng et al (2001), Meng and Yang (2002) and Chiou (2005).
- Discrete variable models were developed and formulated in papers by Billheimer and Gray (1973), Le Blanc (1975), Los (1979), Boyce and Janson (1980), Foulds (1981), Los and Lardinois (1982), Poorzahedy and Turnquist, (1982), Chen and Alfa (1991), Herrmann et al. (1996), Solanki et al (1998), Cruz et al (1999), Drezner and Wesolowsky (2003), Gao et al (2005), Poorzahedy and Abulghasemi (2005), Poorzahedy and Rouhani (2007) and Ukkusuri et al (2007).

For network design problems, multi-criteria technique for urban networks with the use of genetic algorithm proposed by Pattnaik et al (1998), Dhingra et al (2000), Ngamchai and Lovell (2003), Cantarella and Vitetta (2006), Russo and Vitetta (2006). Cantarella et al (2006) also proposes other methods, such as Simulated Annealing (SA), Tabu Search (TS), Path Relinking, Climbing, and Genetic Algorithms. Due to the non-convexity of the transit network design problem as reported in Newell (1979), the best and most efficient solution methods are based on heuristic procedures. For the other most remarkable works about network design, it is possible to mention studies by Baaj and Mahmassani (1992, 1995), Ceder and Israeli (1993), and Carrese and Gori (2002).

This chapter presented a comprehensive literature review about the main seaport terminal operations with optimization and heuristic methods. In each sub section, key references are provided from the literature. In the next chapter, optimization issues and key seaport terminal operation models are introduced and thereby fundamental operation models are classified into each sub sections.

CHAPTER FOUR

DEVELOPMENT OF MODELS

Pure base mathematical models for seaport logistics operations are introduced in this chapter. Key models represent the major problems at seaport terminals, and solution models to these problems vary depending on the method or algorithm used. However, as a general overview to the major problems of container terminal operations, these models can be used to present issues at seaport terminals. For more specific implementations of the key models presented here, some necessary modifications to the mathematical models are needed to match exactly the operational demand.

4.1 Seaport Terminal Problems and Mathematical Models

Human beings constantly make decisions by adopting an optimizing behavior, as the desire is to perform a given task in the best possible way with respect to some unique criterion to minimize costs or maximize benefits (Ehrigott, 2002). As this is the case for any seaport operations, including organizational and process level activities as well. Seaport logistics operations have numbers of problems. These problems are mainly in categories of scheduling, assignment, routing, allocation, shortest distance, etc.

4.1.1 Quay Crane/Yard Crane Scheduling

The scheduling problem with the assumption is that there are n jobs and m machines. Each job must be processed on all machines (i.e. cranes) in a given order. A machine (i.e. crane) can only process one job at a time, and once a job is started on any machine (i.e. crane), it must be processed to completion. The objective is to minimize the sum of the completion times of all the jobs.

Objective function

$$\text{Minimize } Z = \sum_{j=1}^n t_{j(m),j}$$

Subject to

$$t_{j(r+1),j} \geq t_{j(r),j} + P_{j(r),j} \quad \text{for } r = 1, 2, \dots, m-1 \text{ and } \forall j$$

$$t_{ij} - t_{ik} \leq -P_{ij} + U(1 - x_{ijk}) \quad \forall i, j, k$$

$$t_{ik} - t_{ij} \leq -P_{ik} + Ux_{ijk} \quad \forall i, j, k$$

$$t_{ij} \geq 0 \quad \forall i, j$$

$$x_{ijk} \in \{0, 1\} \quad \forall i, j, k$$

where parameters are

n = the number of jobs

m = the number of machines

P_{ij} = the processing time of job j on machine i

$j(r)$ = the order of machines/operations for job j (for example, job j must be processed on machine 2 first ($r=1, i=2$), and then machine 4 ($r=2, i=4$), and so on). For any job j , $r = m$ means the last operation of the job.

and variables:

t_{ij} = the start time of job j on machine i

x_{ijk} = 1 if job j precedes job k on machine i , 0 otherwise (i.e., if job k precedes job j on machine i)

Detailed studies are further investigated by Bierwirth and Meisel (2009), Chen et al. (2007), Goodchild and Daganzo (2007), Kim and Park (2004), Lee et al (2008a), Lee et al (2008b), Liang et al (2008), Lim et al (2002, 2004, 2007), Liu et al (2006), Peterkofsky and Daganzo, (1990), Tavakkoli-Moghaddam et al (2009), Zhu and Lim (2006).

4.1.2 Generalized Assignment Problem (GAP)

The problem is finding a minimal cost (or maximal profit) assignment of n tasks over m capacity-constrained servers (Cheung et al, 2002; Zhang et al, 2002), whereby each task has to be processed by only one server (Sarker, 2008).

Objective function

$$\text{Minimize } Z = \sum_{i=1}^n \sum_{j=1}^m C_{ij} x_{ij}$$

Subject to

$$\begin{aligned} \sum_{j=1}^m x_{ij} &= 1, & i = 1, \dots, n \\ \sum_{i=1}^n a_{ij} x_{ij} &\leq b_j, & j = 1, \dots, n \\ x_{ij} &\in \{0, 1\}, & i = 1, \dots, n, \quad j = 1, \dots, m \end{aligned}$$

where parameters are

- n = number of tasks
- m = number of servers
- C_{ij} = cost of assigning task i to server j
- b_j = units of resource available to server j
- a_{ij} = units of resource required to perform task i by server j

and variables

- x_{ij} = 1 if task i is assigned to server j , 0 otherwise

4.1.3 Scheduling (Employees, Stevedore, etc.)

The problem is to determine the number of employees required to meet the different daily work force necessities of seaport terminal (Li et al, 1998; Pinedo, 2002) while minimizing the general scheduling cost.

Objective function

$$\text{Minimize } Z = \sum_{i=1}^N C_i x_i$$

Subject to

$$\sum_{i \in M_j} x_i \geq R_j \quad \forall j$$

$$x_i \geq 0 \quad \forall i$$

where parameters are

N = the total number of roster type

M_j = the set of roster types that will allow working on a day j

R_j = the number of employees required on each day j

C_i = weekly cost per employee assigned to roster type i

and variables

x_i = the number of employees assigned to roster type i

4.1.4 Routing Problem at Seaport Terminals

The problem is to ascertain the operation plan satisfying the demand at various zones at minimum cost (Bish et al., 2001; Kim and Bae, 1998; Vis and De Koster, 2003).

Objective function is

$$\text{Minimize } f_{obj} = \sum_{i=1}^G \sum_{j=1}^Z \sum_{k=1}^F C_{ijk} x_{ijk}$$

Subject to

$$\sum_{i=1}^G \sum_{k=1}^F L_k x_{ijk} \geq D_j \quad \forall j$$

$$\sum_{j=1}^Z \sum_{k=1}^F L_k x_{ijk} \leq S_i \quad \forall i$$

$$\sum_{j=1}^Z L_k x_{ijk} \leq U_{ki} \quad \forall k, i$$

$$x_{ijk} \geq 0 \quad \forall i, j, k$$

where parameters are

G = Number of source locations (index i)

Z = Number of receiving nodes for containers (index j)

F = Number of trailers available (index k)

L_k = Load capacity of trailer k

S_i = Quantity of available containers for transportation from location i

D_j = Quantity of containers required by zone j

C_{ijk} = Unit cost of transporting from location i to zone j by trailer k

U_{ik} = Maximum allowable containers that can be transported from location i by trailer k in a given period

and variables

x_{ijk} = the number of trips required by trailer k from location i to zone j

4.1.5 Hinterland Operations and Landside Operations (Routing Problem)

A generic model that practitioners encounter in many planning and decision processes (Bish et al, 2001; Kim and Bae, 1998; Vis and De Koster, 2003). For instance, the delivery and collection of containers/cargos, etc.

Objective function is

$$\text{Minimize } Z = \sum_{k=1}^K \sum_{(i,j) \in A} C_{ij} x_{kij}$$

Subject to

$$\sum_{i=1}^n y_{ij} = 1, \quad j = 2, 3, \dots, n$$

$$\sum_{j=1}^n y_{ij} = 1, \quad i = 2, 3, \dots, n$$

$$\sum_{j=1}^n y_{1j} = K$$

$$\sum_{j=1}^n y_{i1} = K$$

$$\sum_{i=1}^n \sum_{j=2}^n D_j x_{kij} \leq U, \quad k = 1, 2, \dots, K$$

$$\sum_{k=1}^K x_{kij} = y_{ij} \quad \forall i, j$$

$$\sum_{(i,j) \in S \times S} y_{ij} \leq |S| - 1, \quad \text{for all subsets } S \text{ of } \{2, 3, \dots, n\}$$

$$x_{kij} = 0 \text{ or } 1 \quad \forall (i, j) \in A \text{ and } \forall k$$

$$y_{ij} = 0 \text{ or } 1 \quad \forall (i, j) \in A$$

- A fleet of M capacitated vehicles located in a depot (i=1)
- A set of target zones (of size N-1), each having a demand D_j (j=2,...,N)
- A cost C_{ij} of traveling from location i to location j
- The problem is to find a set of routes for delivering / picking up goods to/from the target zones at minimum possible cost.

The vehicle fleet is homogeneous and that each vehicle has a capacity of U units.

and variables:

x_{kij} = 1 if the vehicle k travels on the arc i to j , 0 otherwise

y_{ij} = 1 if any vehicle travels on the arc (i,j) , 0 otherwise

4.1.6 Sheltering, Storage, Warehousing Operations – Layout Design

In a warehouse, the operating staff must decide where to locate the different items of goods they receive and later where to deliver the items of goods to. The layout problem is to determine the zones for storing each of the n items that will minimize the total transportation cost between the items and the dock (Kim and Kim, 1998; Taleb-Ibrahimi et al, 1993; Zhang et al, 2003). For the convenience of modeling, the warehouse/storage/sheltering floor area is divided into m square grids of equal size, numbered from 1 to m . Each grid-square can accommodate only one pallet (Sarker, 2008).

Objective function is

$$\text{Minimize } Z = \sum_{i=1}^n \sum_{j=1}^m C_{ij} x_{ij}$$

Subject to

$$\sum_{j=1}^m x_{ij} = G_i \quad \forall i$$

$$\sum_{i=1}^n x_{ij} = 1 \quad \forall j$$

$$x_{ij} \in \{0,1\} \quad \forall i, j$$

where parameters are

G_i = the total number of grid-squares required to store item i (as an item may require more than one grid-square)

- F_i = the average number of pallet loads, for item i , received and delivered in a year
- D_j = the distance between the dock and the center of grid-square j
- P_i = the cost per pallet per unit distance incurred in transporting item i between the dock and its storage region

and decision variables

- x_{ij} = 1 if item i is stored in grid-square j , 0 otherwise

4.1.7 Intermodal Connections and Scheduling

The general problem is a timetabling and scheduling operation planning of the intermodal area where frequent mode changes occur (Gambardella et al, 2001; Stahlbock and Voß, 2008; Steenken et al, 2004).

Objective function is

$$\text{Maximize } Z = \sum_i \sum_j C_{ij} x_{ij}$$

Subject to

$$\begin{aligned} \sum_{j \in J} x_{ij} &= S_i \quad \forall i \in I \\ \sum_{i \in R_l} x_{ij} &\leq A_l \quad \forall j \in J, \quad \forall l \in L \\ \sum_{i \in T_m} x_{ij} &\leq 1 \quad \forall j \in J, \quad \forall m \in M \\ x_{ij} &\in \{0,1\} \quad \forall i \in I \quad j \in J \end{aligned}$$

where parameters are

- I = set of all intermodal groups (index i)
- J = set of time groups (index j)
- L = set of stations groups (index l)
- M = set of intermodal groups in conflict (index m)
- R_l = subset of intermodal groups that can be allocated to stations group l

- T_m = subset of intermodal groups in conflict; the m th row of the conflict matrix
 A_l = number of stations of type l
 S_i = number of materials/cargoes/container in intermodal group i
 C_{ij} = a desirability coefficient of assigning intermodal groups i to time groups j

and with decision variables

- x_{ij} = 1 if intermodal group i is assigned to time group j , 0 otherwise

In this chapter, particular problems of scheduling quay cranes, yard cranes, workforce, trailer/vehicle routing, layout of sheltering, storage, and warehousing operations are introduced. Fundamental problems of optimization, which are as well applicable to seaport terminals, are briefly described, and included from pure base models of Sarker (2008) to address fundamental seaport logistics operations. In the next chapter, innovative methods and algorithms are presented to solve complex optimization problems of logistics terminals. Key operational models are solved with innovative methods and algorithms and solution histories are presented with some further details. In addition to the problem solutions, key terminal equipment characteristic of quay crane is presented and major operational simulations and optimum resource assignment strategies of seaport terminals are presented to address key aspects of seaport terminal operations.

CHAPTER FIVE

SOLUTIONS TO SEAPORT PROBLEMS

This chapter presents comprehensive solutions to the key operational problems of a container terminal. Firstly, innovative cross entropy method is introduced with details of its background mechanism. Then, the method is applied to solve combinatorial optimization problems. Convergence of the method and solution history is provided to present the internal mechanics of the stochastic method. Secondly, another important problem of vehicle routing is introduced and some details of routing problems are presented. Then, scenario based various routing problems are tested and solved both using genetic algorithm technique and cross entropy method. Furthermore, an important seaport terminal equipment characteristics of quay crane is presented and based on the characteristics given, every single details of possible operational characteristics are depicted. Next, storage yard operations and simulation is presented with generalized yard operations. Yard operations problem is solved by using CPLEX's method and resource assignment solutions are shown by using bio-graph technique. Finally, vehicle dispatching and assignment problem is introduced and solutions are provided with distinctive algorithms with various performance results.

5.1 Shortest Distance Problems

This sub section states a key logistic problem and proposes an innovative cross-entropy (CE) algorithm for solving complex combinatorial seaport problems. Computational results exhibit that the CE algorithm is an efficient, convenient, and applicable stochastic method.

5.1.1 The Cross Entropy (CE) Method

Rubinstein developed the CE method in 1997 and it is adapted for combinatorial optimization solutions (Rubinstein 1997, 1999, 2001; Rubinstein and Kroese, 2004; Rubinstein and Melamed, 1998; Rubinstein and Shapiro, 1993). The idea behind the

CE method is to model an effective learning technique throughout the search process of the algorithm to solve combinatorial optimization problems. The method first produces a random sample from a pre-specified probability distribution function and then treats the sample to adjust the parameters of the probability distribution in order to generate a better sample in the next iteration. The stochastic optimization problem is solved by identifying the optimal *importance sampling* (IS) density that minimizes Kullback-Leibler (KL) distance regarding the original density function. KL distance is the cross entropy between the original density function and the importance sampling density function. The distance $D(g, h)$ is determined as a particular suitable criterion between densities of g and h . The KL distance (cross-entropy) is

$$D(g, h) = E_g \ln \frac{g(x)}{h(x)} = \int g(x) \ln g(x) dx - \int g(x) \ln h(x) dx \quad (2)$$

Alternatively, the Kullback-Leibler (KL) divergence of Q from P is depicted as

$$D_{KL}(P, Q) = \sum_x P(x) \log\left(\frac{P(x)}{Q(x)}\right) \quad (3)$$

$$D_{KL}(P, Q) = -\sum_x P(x) \log(Q(x)) + \sum_x P(x) \log(P(x)) \quad (4)$$

$$\text{where } D_{KL}(P, Q) = H(P, Q) - H(P)$$

$H(P, Q)$ is the cross-entropy between P and Q . $H(P)$ is the entropy of P . The minimization of the KL distance (cross-entropy) provides definition for the parameters of the density functions and generations of enhanced feasible vectors. The method aborts when it comes together into a solution in the feasible region.

A general 0-1 integer maximization problem (P) can be defined as

$$(P): \quad z^* = \max_{x \in X} f(x) \quad (5)$$

where $X \subseteq B^n$ represents the feasible region. The CE method associates a stochastic estimation problem to (P). The random vector $X = (X_1, \dots, X_n) \sim \text{Ber}(u)$, and the parameterized vector of v is u . Density function ϕ on X parameterized by a vector $u \in [0, 1]^n$. Consequently, Bernoulli density function, under the following probability density function (pdf) is

$$\phi(x, u) = \prod_{i=1}^n (u_i)^{x_i} (1-u_i)^{1-x_i} \quad (6)$$

and the stochastic estimation problem (EP) is

$$(EP): \quad P_u(f(x) \geq z) = \sum_{x \in X} I_{\{f(x) \geq z\}} \phi(x, u) \quad (7)$$

where P_u is the probability measure value that is based on a given threshold z value where X values drawn from distribution $\phi(\bullet, u)$. The stochastic problem (SP) of the interest where $f(x)$ is greater or equal to a some real number z in the probability of $\phi(x, u)$ is

$$(SP): \quad l = P_u(f(x) \geq z) = \sum_{x \in X} I_{\{f(x) \geq z\}} \phi(x, u) \quad (8)$$

Small probability (e.g. : 10^{-5}) of $l = P_u(f(x) \geq z)$ is called as a *rare event*. $I_{\{f(x) \geq z\}}$ is the indicator function and it takes two values 1 or 0 based on the threshold value of z :

$$I_{\{f(x) \geq z\}} = \begin{cases} 1, & f(x) \geq z \\ 0, & \text{otherwise,} \end{cases} \quad (9)$$

The unbiased estimator of l obtained by drawing a random sample X_1, \dots, X_N from the probability distribution function (pdf) $\phi(\bullet, u)$, by using the crude Monte-Carlo (cMC) simulation, is

$$\hat{l} = \frac{1}{N} \sum_{i=1}^N I_{\{f(x) \geq z\}} \quad (10)$$

where plain definition of cMC is, drawing from a distribution of s of m samples as such s_1, s_2, \dots, s_m , the estimate of $E(f)$ is

$$\hat{E}_m(f) = \frac{1}{m} (f(s_1) + f(s_2) + f(s_3) + \dots + f(s_m))$$

And with probability of 1, $\hat{E}_m(f)$ equals to $E_m(f)$ as such,

$$\lim_{m \rightarrow \infty} \hat{E}_m(f) = E_m(f)$$

The error component ε is calculated as,

$$\varepsilon = \hat{E}_m(f) - E_m(f)$$

The expected value of $E_\phi(f)$ over a distribution ϕ is defined as,

$$E_{\phi}(f) = \int_{\Theta} f(s)\phi(s)ds$$

when the value of f is non-zero with a minor probability, to generate a satisfactory result in terms of relative error ε , cMC method necessitates large numbers of samples. To continue from (10), in case of *rare event* (e.g. $:10^{-5}$) situations for ($f(x) \geq z$) cMC can raise some acute problems. Thus, as an alternate, a random sample X_1, \dots, X_N from an *importance sampling* (IS) can be taken with a density θ on X :

$$\hat{l} = \frac{1}{N} \sum_{i=1}^N I_{\{f(X_i) \geq z\}} \frac{\phi(X_i, u)}{\theta(X_i)} \quad (11)$$

thus, the expected value of the new estimate $E_{\theta}(f)$ is,

$$\begin{aligned} E_{\theta}(f(s_i) \frac{\phi(s)}{\theta(s)}) &= \int_{\Theta} f(s) \frac{\phi(s)}{\theta(s)} \theta(s) ds \\ &= \int_{\Theta} f(s) \phi(s) ds = E_{\phi}(f) \end{aligned}$$

At (11), \hat{l} is the *likelihood ratio* (LR) or the *importance sampling* (IS) estimator.

The reference vector (p) is estimated by

$$\hat{p} = \arg \max_p \frac{1}{N} \sum_{i=1}^N I_{\{f(X_i) \geq z\}} \ln \phi(X_i, p) \quad (12)$$

and the solution of the reference vector \hat{p} is obtained by taking the partial differentiation with respect to p_j :

$$\frac{\partial}{\partial p_j} \frac{1}{N} \sum_{i=1}^N I_{\{f(X_i) \geq z\}} \ln \phi(X_i, p) = 0 \quad (13)$$

this gives the optimal updating rule:

$$\hat{p}_j = \frac{\sum_{i=1}^N I_{\{f(X_i) \geq z\}} X_{ij}}{\sum_{i=1}^N I_{\{f(X_i) \geq z\}}}, \quad j = 1, \dots, n \quad (14)$$

The objective of the algorithm is to increase z threshold values in each iteration (z^0, z^1, \dots) and then converge z into a value near global optimum or a global optimum value z^* . With an initial p^0 vector, at each iteration τ , a new value of z^τ involves for the creation of new $p^{\tau+1}$ vector. $p^{\tau+1}$ vector is then used to draw sample population to generate $z^{\tau+1}$. At each iteration, better p vectors (p^0, p^1, \dots) are created and each of these vectors are used to generate better z (z^0, z^1, \dots) values. Algorithm will stop when z converges to a global optimum value z^* or the vector p converges to a vector in X .

The pseudo-code for the cross-entropy algorithm is,

1. Let p^0 be an initial probability transition matrix;

$$p^0 = \begin{bmatrix} 0 & p_{(1,2)} & \cdots & p_{(1,n)} \\ p_{(2,1)} & 0 & \cdots & p_{(2,n)} \\ \vdots & \vdots & \vdots & \vdots \\ p_{(n-1,1)} & p_{(n-1,2)} & 0 & p_{(n-1,n)} \\ p_{(n,1)} & p_{(n,2)} & \cdots & 0 \end{bmatrix}$$

where the probability $p_{(r,s)}$ matches the transition from the node r to the node s .

Assume $r \neq s$ and $p_{(r,s)} \neq 0$

N is the sample size, ρ is the cutoff constant for quality observations, α is the smoothing constant, k is the iteration limit; is the total iterations limit.

2. Sample size is controlled by ρ , so **set** $\rho = 0.01$;
3. $f(x^*) = 0$
4. **Set** $t = 0$ and $t' = 0$
5. **while** ($t' < k$ and $t < K$) {

6. Generate a sample of size N , where the probability that $x_j^s = 1$ is p_j^t , for $j = 1, \dots, n-1, n$ and for $s = 1, \dots, N-1, N$
7. Order the sample $f(x^1) \geq f(x^2) \geq f(x^3) \geq \dots \geq f(x^N)$, $\forall s$
8. Compute vector $v_j = \frac{\sum_{s=1}^{\rho N} x_j^s}{\rho N}$, for $j = 1, \dots, n-1, n$
9. Update $p_j^t = \alpha v_j + (1 - \alpha) p_j^{t-1}$, for $j = 1, \dots, n-1, n$, smoothed by α value.
10. **if** ($f(x^*) \geq f(x^1)$) {
11. increment t' value by 1, **set** $t' = t' + 1$
12. } **else** {
13. **set** $x^* = x^1$ and **set** $f(x^*) = f(x^1)$
14. **set** $t' = 0$
15. }
16. increment t value by 1, **set** $t = t + 1$
17. }

5.1.2 Applying the Cross Entropy (CE) Method – Shortest Distance Problem

Among operational problems, for testing purposes of the algorithm, shortest distance problem at one short time fraction with an intense terminal traffic conditions and dynamically assigned distance nodes scenario has been considered. Multiple vessels are serviced at the terminal. Quay cranes charges and/or discharges containers at berthing and marshaling area (See Fig. 5.1, 5.2). A typical loading and unloading operation of containers at seaport terminals involve quay cranes in charging or discharging operation, multiple-trailers with loaded/unloaded containers, and stacking/gantry cranes at yard area for delivering containers to/from stacking area.

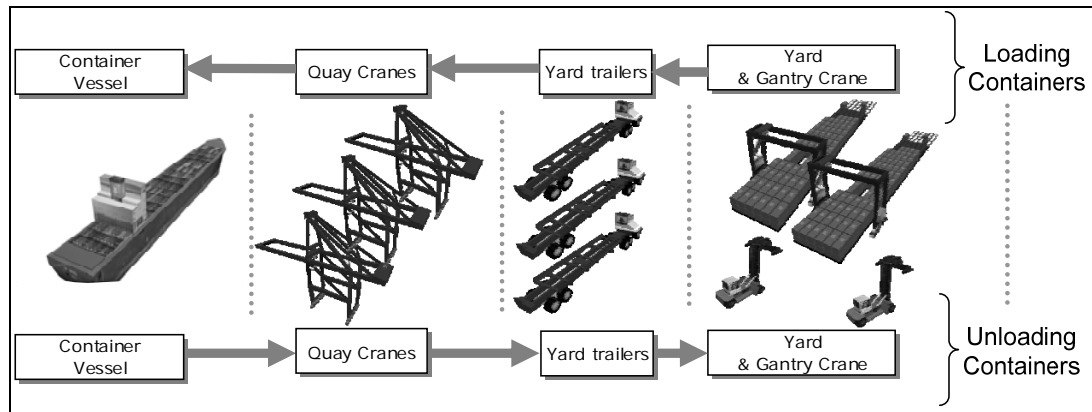
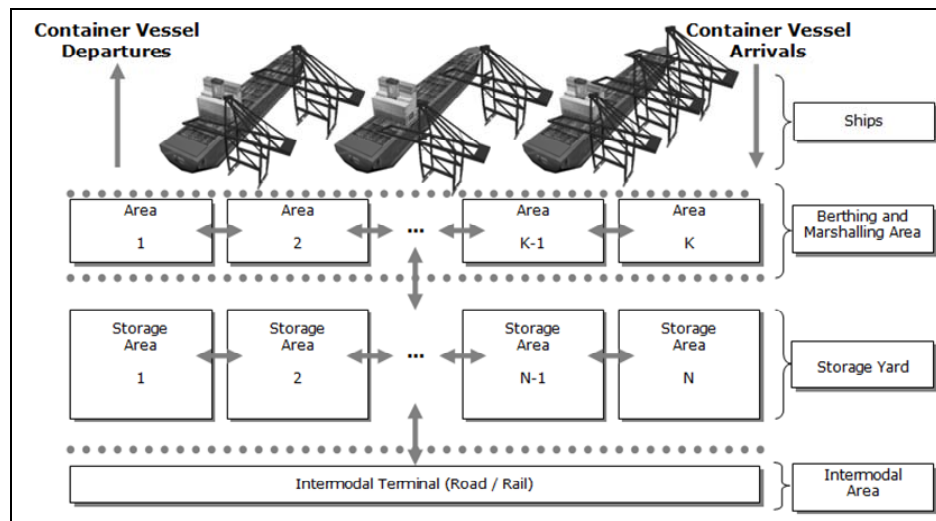
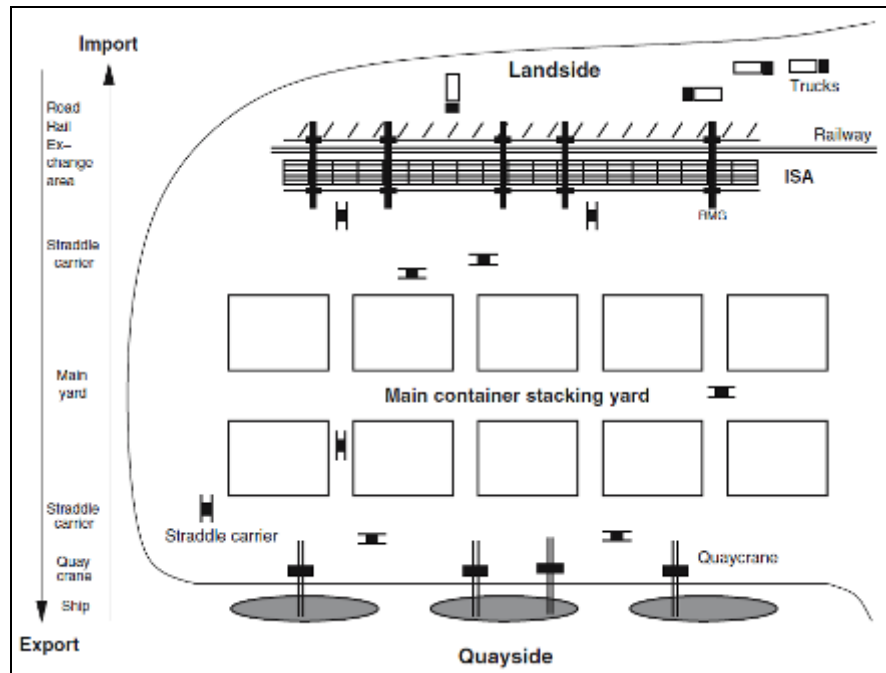

Figure 5.1 Seaport terminal operations – Seaside and yard area

In a dynamically managed seaport *seaside* and *yard side* operations, multiple-trailers pick up containers from quay cranes (QCs) in discharging operation. Then, trailers deliver containers at the yard area to the assigned stack area for discharged containers. After the delivery operations, trailers can visit another quay crane in discharging and/or trailers can visit assigned stack area at yard for export containers. As such, dynamic routes increase productivity for terminal services.



(a)



(b)

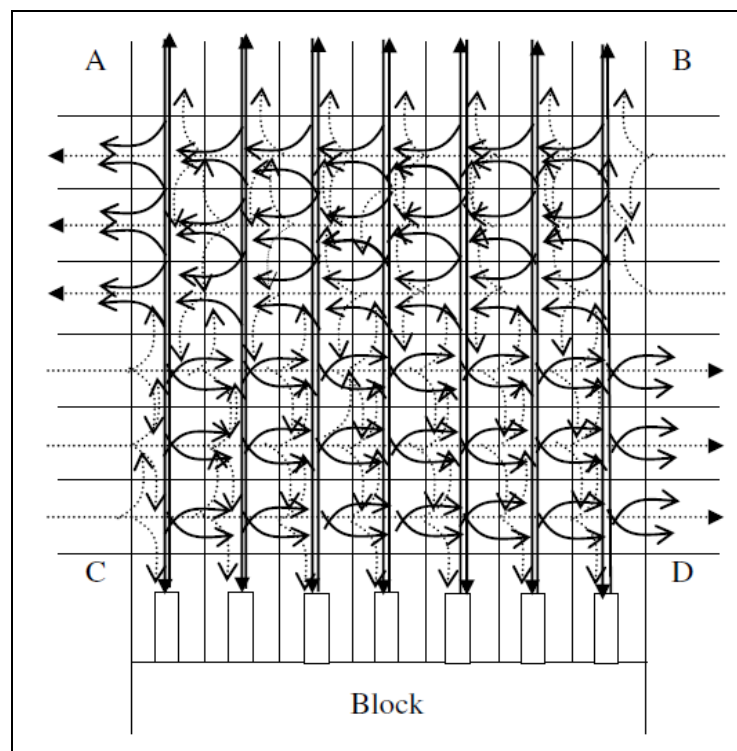

(c)

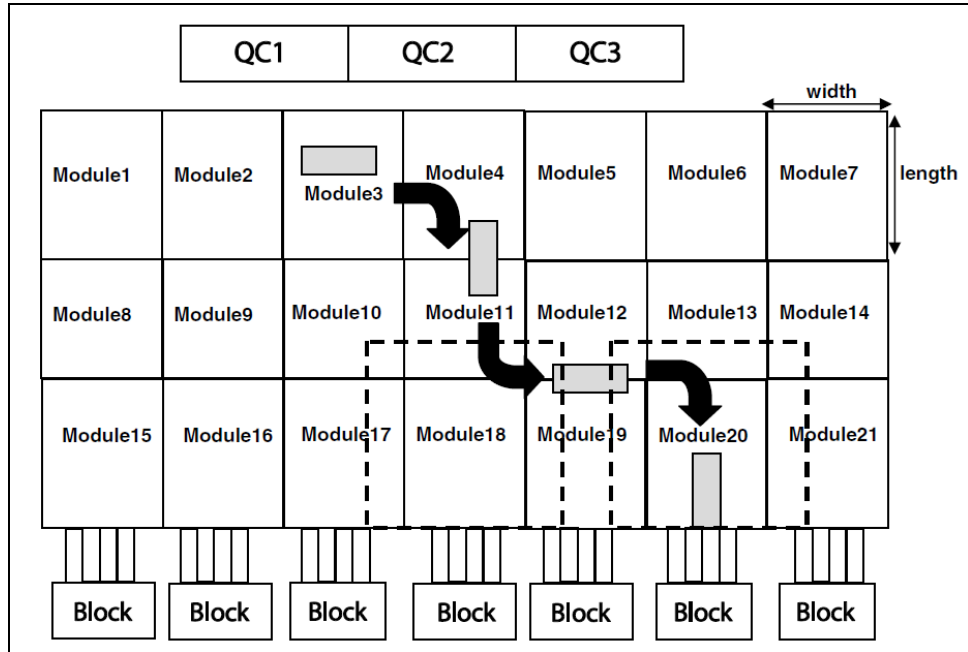

(d)

Figure 5.2 (a) Seaport terminal operations – Yard and land area (b) Seaport terminal operations – Yard and land area (Source: Froyland et al., 2008) (c) Travel routes models in front of a block (Source: Kim et al., 2006) (d) Partitioning the traveling into modules (Source: Kim et al., 2006)

Shortest distance problem at one short time fraction with an intense terminal traffic conditions and thus, dynamically assigned path nodes for dynamic yard operations (nodes network) can be modeled by a graph $G = (V, E)$ where it comprises a set of vertices or nodes V and a set of E of edges or lines. A tour at the yard area within the dynamically assigned path nodes can be represented via a permutation $\tau = (\tau_1, \tau_2, \dots, \tau_n)$. The shortest distance at yard area is formulated as,

Objective function is

$$\text{Minimize } Z = \sum_{(i,j) \in A} C_{ij} x_{ij}$$

Subject to

$$\sum_{\{j:(j,i) \in A\}} x_{ji} - \sum_{\{i:(i,j) \in A\}} x_{ij} = -1 \text{ if } i = s, 0 \text{ if } i \neq s \text{ or } d \quad \forall i \in N, 1 \text{ if } i = d$$

$$x_{ij} \geq 0 \quad \forall (i, j) \in A$$

where

- N set of number of nodes at seaport terminal (seaside nodes and yard area/stacking area nodes)
- A set of existing arcs (i,j)
- C_{ij} arc length (or arc cost) united with each arc (i,j)
- $i = s$ for source node, or $i = d$ for destination node
- x_{ij} is the flow from node i to node j

The objective function is to minimize the total distance that is dynamically defined on the seaside and yard area. Constraints ensure that the every point (nodes) visited only once and all these points are included in a tour. (Fig. 5.3)

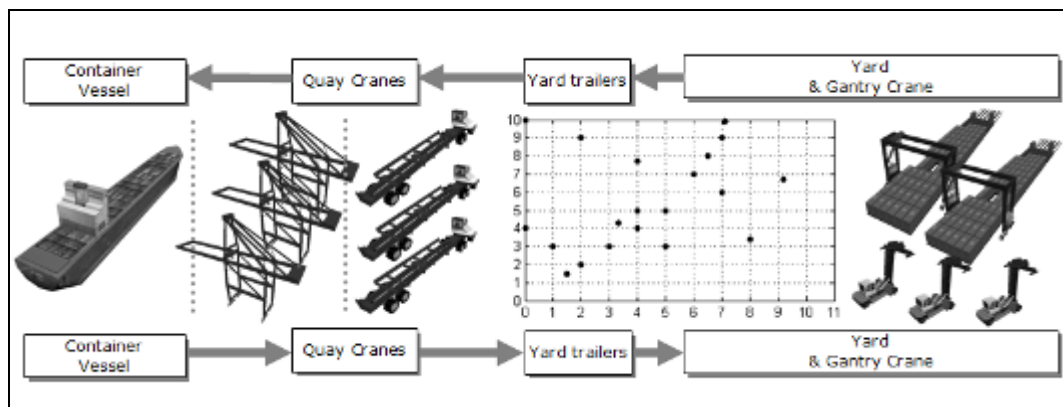

(a)

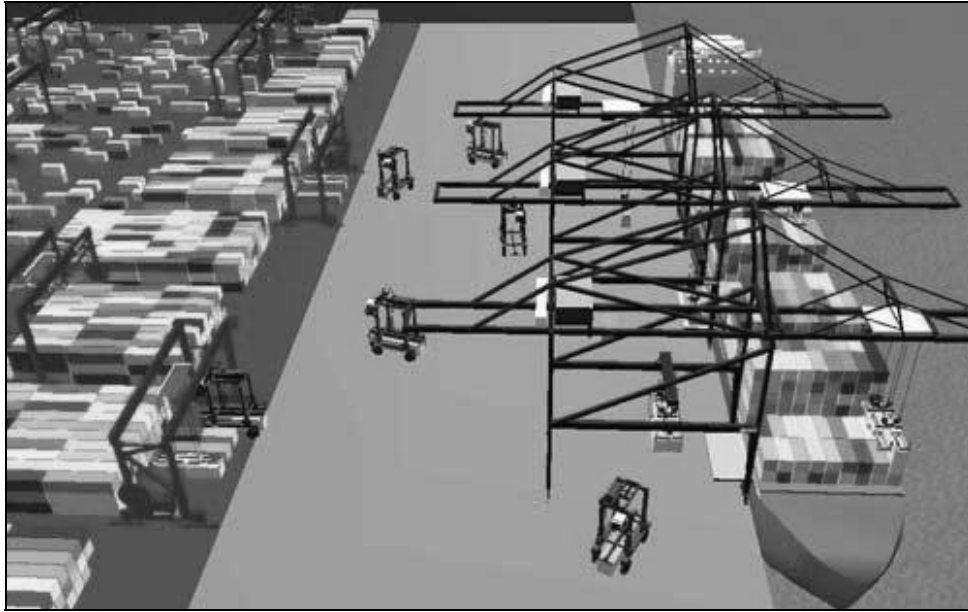

(b)

Figure 5.3 (a) Seaside and yard area with dynamically assigned sample nodes at a fraction of time and at intense traffic conditions on yard area for charge/discharge and transfer operations. (b) Charge/discharge and transfer operations. (Simulation image source: Kalmar Industries, 2009)

To solve the optimization problem, as an example; 22 nodes (x, y pairs) are chosen randomly on a Cartesian coordinate system (xy plane) (See Fig. 5.4) where x, y pairs two-dimensionally represents the seaside and yard area charging/discharging locations of seaport terminal. Y -axis on the fig. 5.4 represents the berthing area and nodes on the y -axis are location of cranes with charging/discharging containers.

$X = [5.0, 1.5, 2.0, 3.0, 4.0, 5.0, 6.0, 7.0, 4.0, 7.0, 0.0, 1.0, 6.0, 4.0, 2.0, 0.0, 4.0, 3.3, 9.2, 8.0, 7.1, 6.5]$
 $Y = [3.0, 1.5, 2.0, 3.0, 4.0, 5.0, 7.0, 9.0, 5.0, 6.0, 4.0, 3.0, 7.0, 4.0, 9.0, 10.0, 7.7, 4.3, 6.7, 3.4, 9.9, 8.0]$

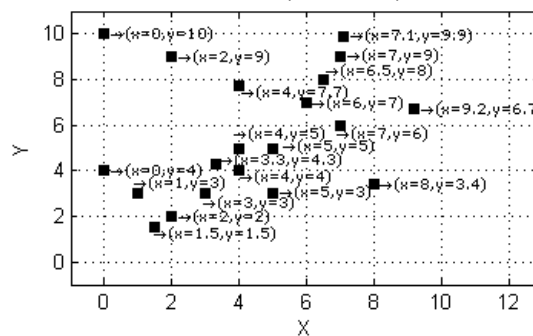

Figure 5.4 Location of the sample nodes (x, y pairs) on seaside and yard area (xy plane).

In Euclidean system, if two points are $p = (p_1, p_2)$ and $q = (q_1, q_2)$, then the distance $d(p, q)$ between p and q is

$$d(p, q) = \sqrt{(p_1 - q_1)^2 + (p_2 - q_2)^2}$$

For each node (x,y pairs) a distance (cost) matrix L is generated. At fig. 5.5, the distance matrix has been displayed as a rectangular array of gray-toned cells. Apart from the dark cross sectional line (which indicates zero distances between identical nodes), darker cells depict longer distances between two nodes, and lighter cells depict nearby distances between two nodes.

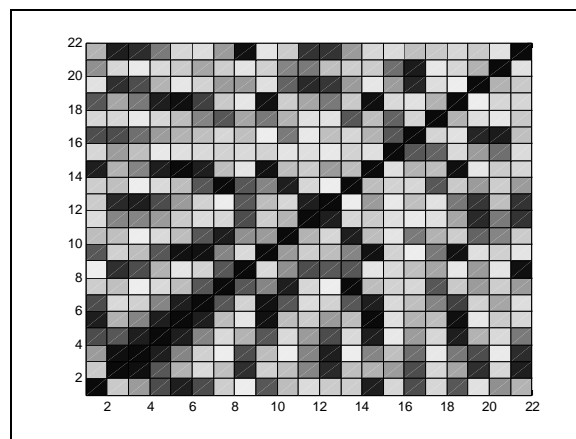

Figure 5.5 The distance matrix of XY pairs - between sample nodes of x,y pair

```
% Initial values used for the CE algorithm at MatLab(R).
rho = 0.03      % threshold for selecting the best rho*N paths
alpha = 0.8    % weight for updating transition matrix - smoothing parameter (0,1)
beta = 0.9     % keeping the fraction of Nrho*N in each iteration
% (22 sample nodes) Coordinates of the nodes on xy plane (nodes at seaport yard area)
V = [5.0 3.0   1.5 1.5   2.0 2.0   3.0 3.0   4.0 4.0   5.0 5.0
     6.0 7.0   7.0 9.0   4.0 5.0   7.0 6.0   0.0 4.0   1.0 3.0
     6.0 7.0   4.0 4.0   2.0 9.0   0.0 10.0  4.0 7.7   3.3 4.3
     9.2 6.7   8.0 3.4   7.1 9.9   6.5 8.0];
```

Figure 5.6 Initial parameters used for testing the CE method on solving the shortest distance problem (at MatLab®)

At first, generating the initial transition matrix p^0 for 22 sample nodes in the form shown below,

$$p^0 = \begin{bmatrix} 0 & p_{(1,2)} & \cdots & p_{(1,22)} \\ p_{(2,1)} & 0 & \cdots & p_{(2,22)} \\ \vdots & \vdots & \vdots & \vdots \\ p_{(21,1)} & p_{(21,2)} & 0 & p_{(21,22)} \\ p_{(22,1)} & p_{(22,2)} & \cdots & 0 \end{bmatrix}$$

where p^0 has zeros in the diagonal and all the remaining elements are equal, as calculated by $1/(N-1)$ which is $1/(22-1)=0.0476$. Rows and columns of the matrix (22X22 matrix) add up to 1. Thus, any route at first has equal likelihood (See Fig. 5.7) to be generated:

$$p^0 = \begin{bmatrix} 0 & 0.0476_{(1,2)} & \cdots & 0.0476_{(1,22)} \\ 0.0476_{(2,1)} & 0 & \cdots & 0.0476_{(2,22)} \\ \vdots & \vdots & \vdots & \vdots \\ 0.0476_{(21,1)} & 0.0476_{(21,2)} & 0 & 0.0476_{(21,22)} \\ 0.0476_{(22,1)} & 0.0476_{(22,2)} & \cdots & 0 \end{bmatrix}$$

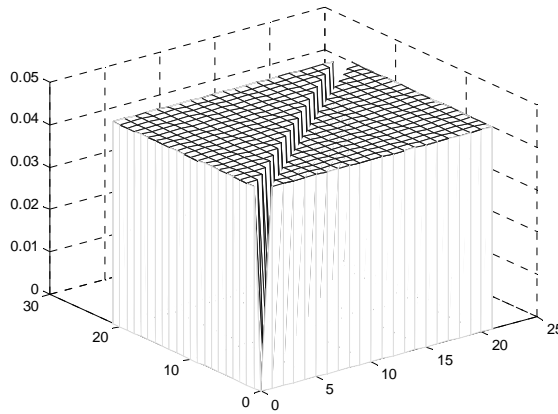

Figure 5.7 Initial probability transition matrix p^0 generated for 22 chosen sample nodes (22X22).

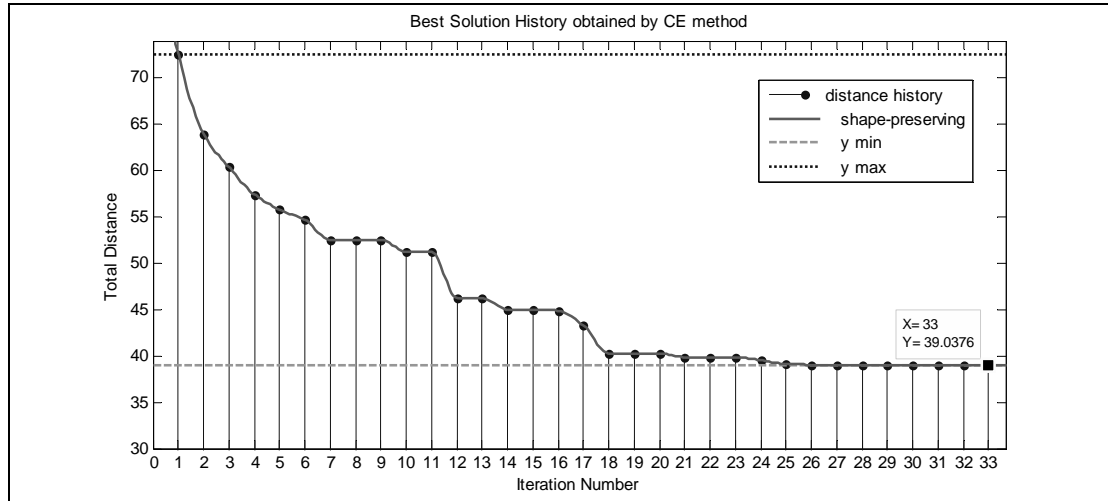

Figure 5.8 The best solution history obtained by the CE method.

Table 5.1 The best solution history obtained by the CE method.

Iter.No.	Total Distance	Iter.No.	Total Distance	Iter.No.	Total Distance	Iter.No.	Total Distance	Iter.No.	Total Distance
1	72,51	8	52,51	15	45,03	22	39,87	29	39,04
2	63,94	9	52,51	16	44,88	23	39,87	30	39,04
3	60,39	10	51,23	17	43,26	24	39,53	31	39,04
4	57,43	11	51,23	18	40,26	25	39,11	32	39,04
5	55,77	12	46,24	19	40,26	26	39,04	33	39,04
6	54,66	13	46,24	20	40,26	27	39,04		
7	52,51	14	45,03	21	39,87	28	39,04		

As in the dynamics of the CE algorithm, at each iteration, better p vectors (p^0, p^1, \dots) are created and each of these vectors are used to generate better z (z^0, z^1, \dots) values. See at table 1, iterations 1 through 33. Algorithm stops when z converges to a global optimum value z^* . Thus, the total distance reduces gradually. Optimal solution was found at the last (i.e. 33rd) iteration (See fig. 5.8 and table 5.1), and optimal tour was obtained at the end of the last iteration.

Fig. 5.9 depicts the dynamics of CE algorithm at each iteration, as sequence of matrixes for the shortest distance problem with generated matrixes of $\hat{P}_0, \hat{P}_1, \hat{P}_2, \dots$ where, at the last iteration optimal tour (minimum distance) has been reached.

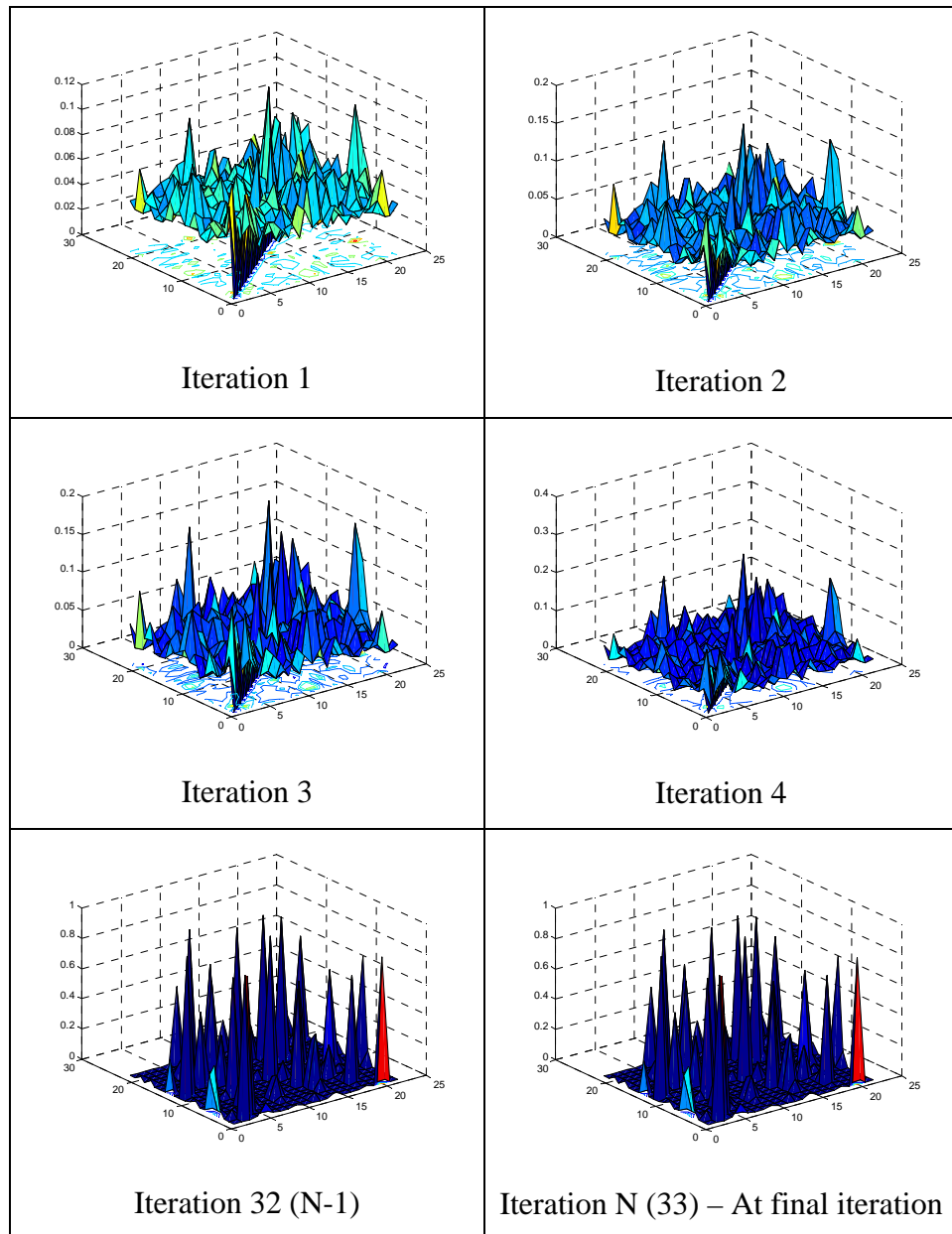

Figure 5.10 Transition probabilities matrix (nxn)

5.1.3 About the CE Method

Comparison of algorithms from different theoretical and empirical categories is a complicated task. Owing to the fact that there is not a specific empirical baseline, that enables unbiased comparison among algorithms. For instance, the CE method and the genetic algorithm (GA) method are in the same population-based heuristic methods. The CE uses an effective learning method throughout the search, whereas the GA method enhances the created samples from generation to generation. GA

method uses genetic encoding which is suited to a particular use of some problems and its processing time is much longer while solving small-scale problems.

Other metaheuristic algorithms (Aarts and Korst, 1989; Goldberg, 1989; Dorigo et al., 1999; Ehrgott, 2002) such as simulated annealing (SA), tabu search (TS), ant colony optimization (ACO), particle swarm optimization (PSO), memetic algorithms (MA) and many others are quite common in solving numerous kinds of problems. On the other hand, there are important differences among them. These differences originate from theoretical and empirical grounds of algorithms. For instance, the main distinction between the CE method and SA is that SA can be considered as a local search algorithm while on the contrary, CE is a global search one. This means that CE method continuously seeks the global optimal solution across the big picture; on the other side, SA method may fail to provide the global optimal and be unable to progress with the task by trapping to the state or condition of a local optimal solution.

Based on the number and complexity of seaport processes, obtaining optimal solutions with heuristic methods is a non-deterministic polynomial-time (NP) hard problem and computational time exponentially increases depending on the number of resources involved in the problem. It is described particularly with detail in this chapter that the CE algorithm's approach provides solid stable solutions by discovering optimal values. By utilizing and integrating the proposed high performing CE algorithm for the problems of seaport terminals, it is apparent that there will be significant improvements in seaport terminal services.

In this chapter, cross-entropy (CE) approach is proposed for solving seaport terminal problems. CE is a modern and an innovative metaheuristic method introduced by Rubinstein in 1997. The method transforms the deterministic problem into a stochastic one and then uses rare event simulation techniques to solve the problem. The method involves an iterative procedure with two stages. Based on a specified mechanism, it first generates a random data sample and then it updates the parameters of the random mechanism based on the data to produce better sample for

the next iteration (Rubinstein, 1999). Recently, cross-entropy method has been receiving a great deal of attention from researchers, as this method has an ability to deal effectively with combinatorial optimization problems. This method has been successfully applied to complicated combinatorial optimization problems.

5.2 Solutions to Trailer Routing Problems

The container truck transportation is a very important problem. Although, in comparison to maritime transportation of containers, container truck transportation is relatively short, but road transportation implies higher costs. There are usually three types of sites: The container terminal, depot, and customer (See Fig. 5.10). In this section, network design problems for container truck transportation are considered with various possible scenarios.

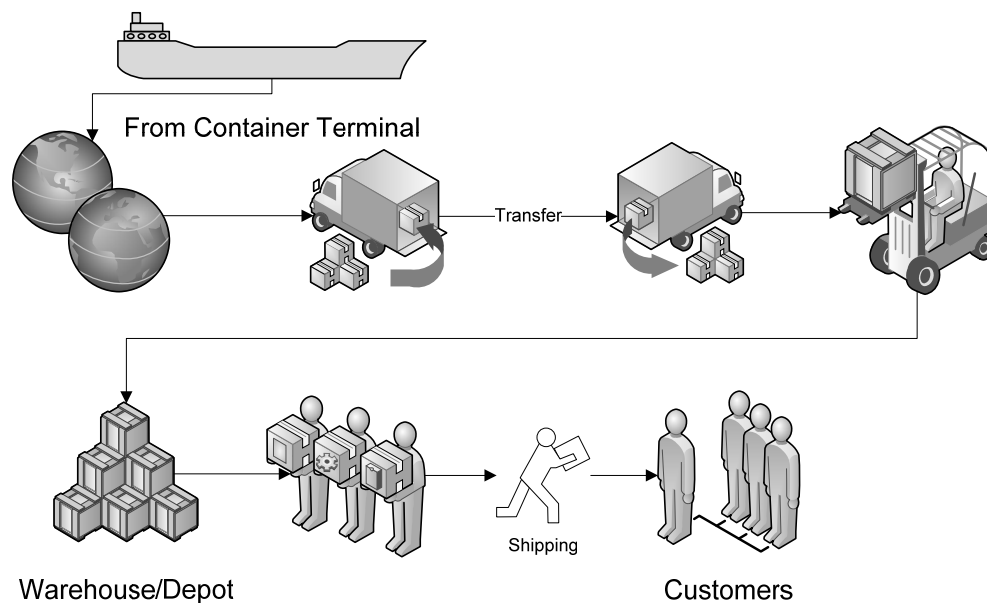

Figure 5.10 The transfer of packages: The container terminal, depot, customer

There are four major decision areas in supply chain management, and there are both strategic and operational elements in each of these areas: location, production, inventory, transportation — distribution (Pardalos, 2002). The distribution of commodities, known by the generic name vehicle routing problem, is one of the most important components of supply chain. The vehicle routing problem, which is a hard combinatorial problem, has therefore attracted considerable research attention and a number of algorithms have been proposed for its solution (Pardalos, 2002).

5.2.1 Problem Statement

The network design problem is known to be a very complicated problem, for three reasons (Kutz, 2003): the combinatorial nature of the problem, the perspective on the design objectives and the strong relationship between the demand for transport networks and transport networks themselves. See fig. 5.11 – Simple vehicle routing graph.

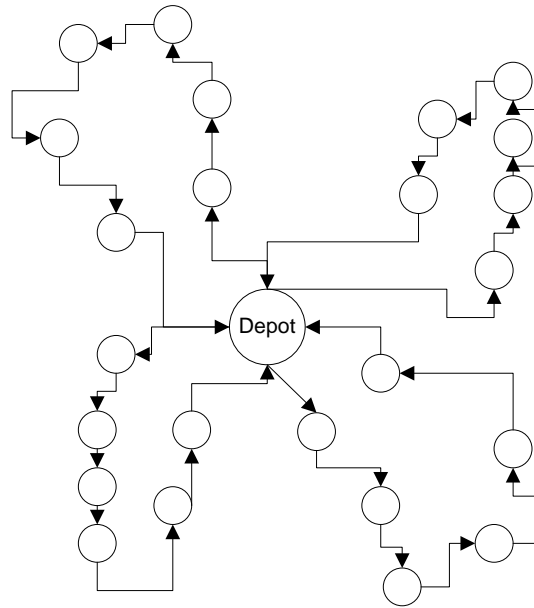

Figure 5.11 Vehicle routing graph – i.e. One central location and delivery nodes

- First, there is the combinatorial nature of the problem. Given a set of access nodes the number of possible link networks connecting all access nodes increases more than exponentially with the number of access nodes. Therefore, there are no efficient methods available for solving large-scale network design problems.
- Second, the perspective on the design objectives might be very different. The key conflict is that between the network user, i.e., the traveler, and the investor or network builder. The traveler prefers direct connections between all origins and destinations, while the investor favors a minimal network in space.
- Third, there is a strong relationship between the demand for transport networks and transport networks themselves. Changes in transport networks

lead to changes in travel behavior, and changes in travel behavior set requirements for the transport network.

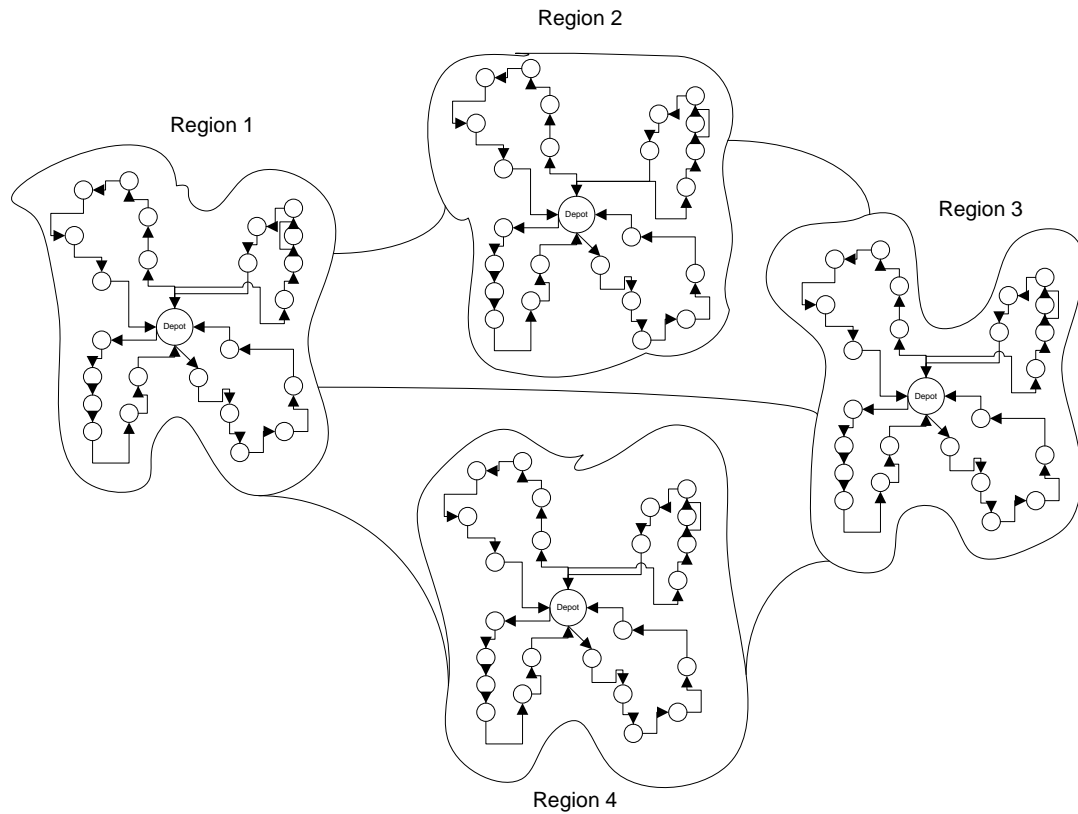

Figure 5.12 Typical container truck transport network

Shortest distance problem solution for transportation nodes (See fig. 5.12 for a sample network.) network can be modeled by a graph $G = (V, E)$ where it comprises a set of vertices or nodes V and a set of E of edges or lines. A tour can be represented via a permutation $\tau = (\tau_1, \tau_2, \dots, \tau_n)$ with $\tau_1 = 1$. Shortest distance for transportation nodes network is formulated as,

Objective function is

$$\text{Minimize } Z = \sum_{(i,j) \in A} C_{ij} x_{ij}$$

Subject to

$$\sum_{\{j:(j,i) \in A\}} x_{ji} - \sum_{\{i:(i,j) \in A\}} x_{ij} = -1 \text{ if } i = s, 0 \text{ if } i \neq s \text{ or } d \quad \forall i \in N, 1 \text{ if } i = d$$

$$x_{ij} \geq 0 \quad \forall (i, j) \in A$$

where

- N set of number of nodes
A set of existing arcs (i,j)
C_{ij} arc length (or arc cost) united with each arc (i,j)
i = s for source node, or i = d for destination node
x_{ij} is the flow from node i to node j

Routing problem I: The problem is to ascertain the operation plan satisfying the demand at various zones at minimum cost.

Objective function is

$$\text{Minimize } f_{obj} = \sum_{i=1}^G \sum_{j=1}^Z \sum_{k=1}^F C_{ijk} x_{ijk}$$

Subject to

$$\sum_{i=1}^G \sum_{k=1}^F L_k x_{ijk} \geq D_j \quad \forall j$$

$$\sum_{j=1}^Z \sum_{k=1}^F L_k x_{ijk} \leq S_j \quad \forall i$$

$$\sum_{j=1}^Z L_k x_{ijk} \leq U_{ki} \quad \forall k, i$$

$$x_{ijk} \geq 0 \quad \forall i, j, k$$

where parameters are

- G = Number of source locations (index i)
Z = Number of receiving nodes for containers (index j)
F = Number of trailers available (index k)

L_k = Load capacity of trailer k

S_i = Quantity of available containers for transportation from location i

D_j = Quantity of containers required by zone j

C_{ijk} = Unit cost of transporting from location i to zone j by trailer k

U_{ik} = Maximum allowable containers that can be transported from location i by trailer k in a given period

and variables

x_{ijk} = the number of trips required by trailer k from location i to zone j

Routing Problem II: A generic model that practitioners encounter in many planning and decision processes. For instance, the delivery and collection of containers/cargos, etc.

Objective function is

$$\text{Minimize } Z = \sum_{k=1}^K \sum_{(i,j) \in A} C_{ij} x_{kij}$$

Subject to

$$\sum_{i=1}^n y_{ij} = 1, \quad j = 2, 3, \dots, n$$

$$\sum_{j=1}^n y_{ij} = 1, \quad i = 2, 3, \dots, n$$

$$\sum_{j=1}^n y_{1j} = K$$

$$\sum_{j=1}^n y_{i1} = K$$

$$\sum_{i=1}^n \sum_{j=2}^n D_j x_{kij} \leq U, \quad k = 1, 2, \dots, K$$

$$\sum_{k=1}^K x_{kij} = y_{ij} \quad \forall i, j$$

$$\sum_{(i,j) \in S \times S} y_{ij} \leq |S| - 1, \quad \text{for all subsets } S \text{ of } \{2, 3, \dots, n\}$$

$$x_{kij} = 0 \text{ or } 1 \quad \forall (i, j) \in A \text{ and } \forall k$$

$$y_{ij} = 0 \text{ or } 1 \quad \forall (i, j) \in A$$

- A fleet of M capacitated vehicles located in a depot (i=1)
- A set of target zones (of size N-1), each having a demand D_j (j=2,...,N)
- A cost C_{ij} of traveling from location i to location j
- The problem is to find a set of routes for delivering / picking up goods to/from the target zones at minimum possible cost.

The vehicle fleet is homogeneous and that each vehicle has a capacity of U units.

and variables:

x_{kij} = 1 if the vehicle k travels on the arc i to j, 0 otherwise

y_{ij} = 1 if any vehicle travels on the arc (i,j), 0 otherwise

For other detailed studies refer to Bish et al (2001), Kim and Bae (1998), Vis and De Koster (2003).

To determine the robustness of the network, various possibilities are open, such as (Kutz, 2003):

- Calculating the effects of fluctuations in demand and/or supply (e.g., as a result of the occurrence of an incident) and
- Temporarily restricting the capacity of one or more links in a network allows the effects of this on the quality of the traffic flow to be calculated.

5.2.2 Genetic Algorithm (GA)

The term genetic algorithm, abbreviated nowadays to GA, was first used by Holland, whose book *Adaptation in Natural and Artificial Systems* of 1975 was instrumental in creating what is now a flourishing field of research and application that goes much wider than the original GA (Reeves, 2002). The genetic algorithm is an optimization technique that simulates the phenomenon of natural evolution (as first observed by Charles Darwin). In natural evolution, species search for increasingly beneficial adaptations for survival within their complex environments (Tim, 2003).

The genetic algorithm, instead of trying to optimize a single solution, works with a population of candidate solutions that are encoded as chromosomes. Within the chromosome are separate genes that represent the independent variables for the problem at hand (Tim, 2003). (See fig. 5.13)

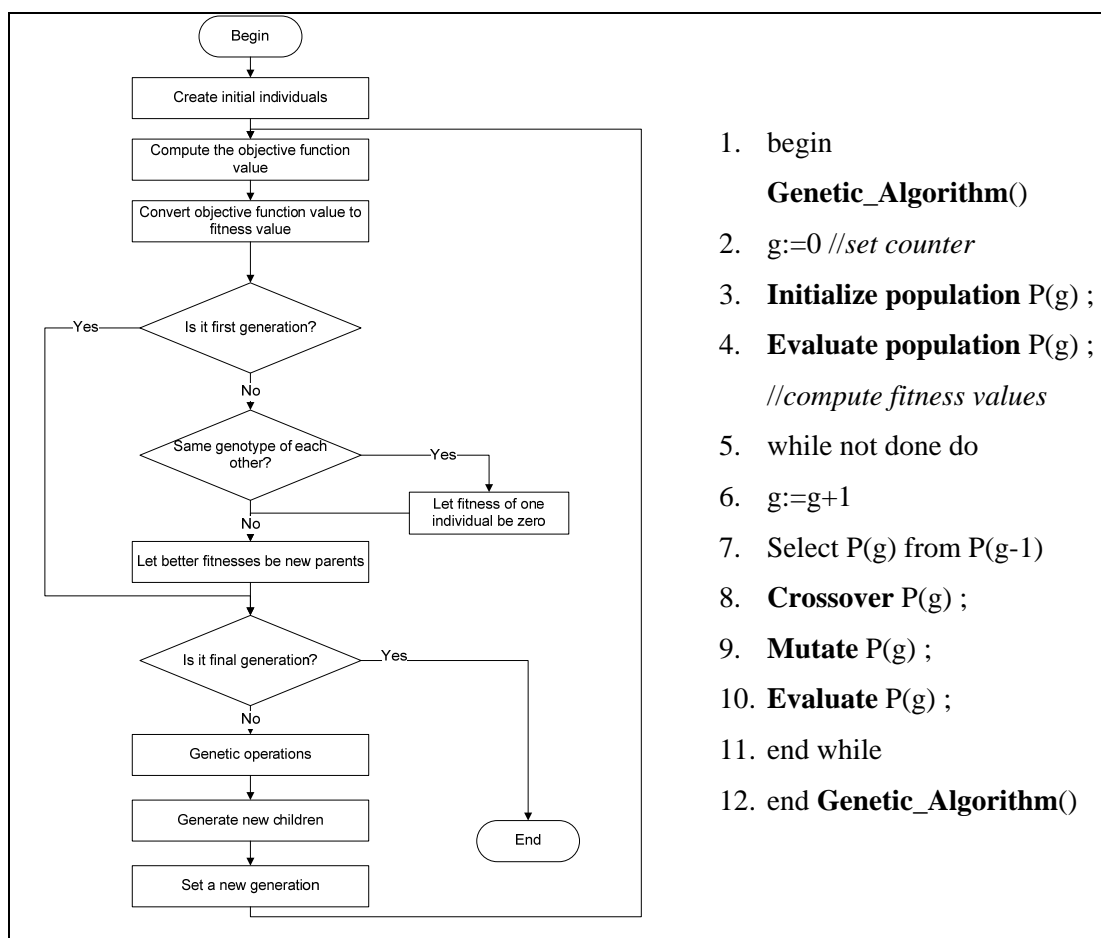

Figure 5.13 Flowchart of the genetic algorithm (Goldberg, 1989) and pseudo-code for genetic algorithm

Genetic algorithms operate on populations of strings, with the string coded to represent the underlying parameter set. Selection (reproduction), crossover, and mutation are applied to string populations to create new string population (Sivanandam et al, 2008).

By referring to the GA description made by Claudio et al in 2007; GAs are one of the most popular heuristic algorithms that represent a powerful and robust approach for developing heuristic for complex and large-scale combinatorial optimization problems (Claudio et al, 2007):

- A GA can be described as a probabilistic search, which imitates the process of natural selection and evolution to evolve a population of initial solutions.
- Each solution of a problem is treated as an individual, whose fitness is governed by the corresponding objective function value and some penalization to infeasibility.
- Pairs of individuals of a given population are selected to act as parents and reproduce to generate the next population of better individuals through a structured yet randomized information exchange known as crossover operator.
- Diversity is added to the population by randomly changing some genes (mutation operator).
- As new “offspring” are generated, unfit individuals in the population are replaced using the concept of survival of the fittest.
- This evaluation–selection–reproduction cycle is repeated until a satisfactory solution is found or other stopping criteria are met

The genetic algorithm can be used in a variety of optimization problems. Since the usefulness of the genetic algorithm depends most highly on the representation of the solution, any number of numerical and symbolic problems can be optimized (Tim, 2003).

5.2.3 *Various Scenarios and Network Configurations*

In this section, some various possible scenarios are taken into consideration while designing a transport network. On randomly distributed locations, *how heuristics methods can be applied to satisfy specific transport network design needs* are considered. Developed scenarios are based on a theoretical assumption that city locations are all accessible from every direction without geographical limitation, other constraints, and route affecting factors. Thus, based on the assumption, five scenarios are introduced. Scenarios 1 through 4 are developed using genetic algorithm and the last scenario developed by the cross entropy method. Both GA and CE network designs are generated and simulated by utilizing Matlab® codes. For more information about the details of the Matlab® GA and CE algorithm methods and codes, refer to appendix section.

Scenario 1

In this scenario, closed loop transportation networks for 20 locations with 4 trucks are considered. Randomly distributed locations on an XY plane and fixed number of vehicles, e.g. 4 trucks, are given a task to visit all of their assigned locations as such that the total distance travelled by these vehicles will be at minimum.

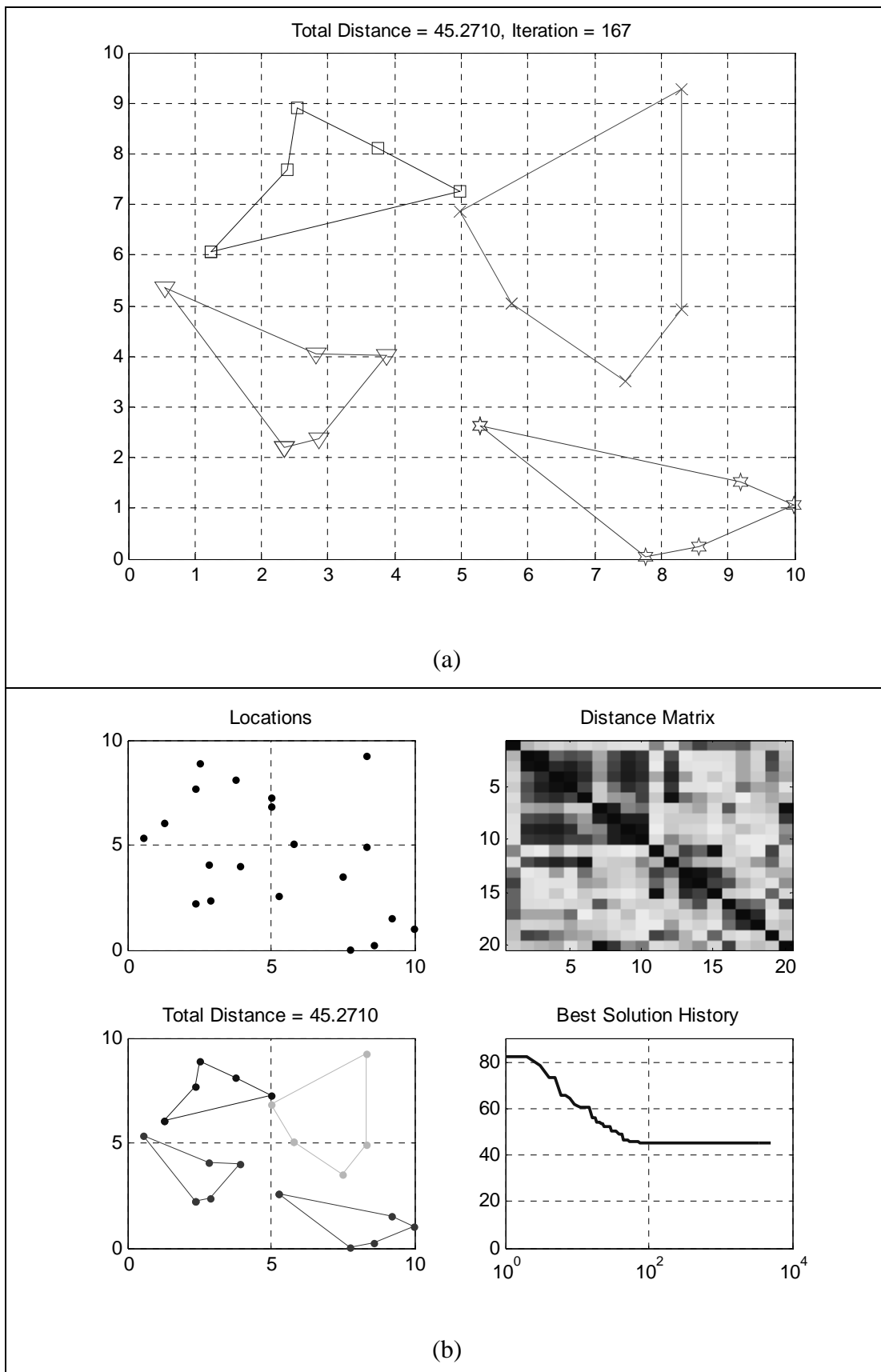
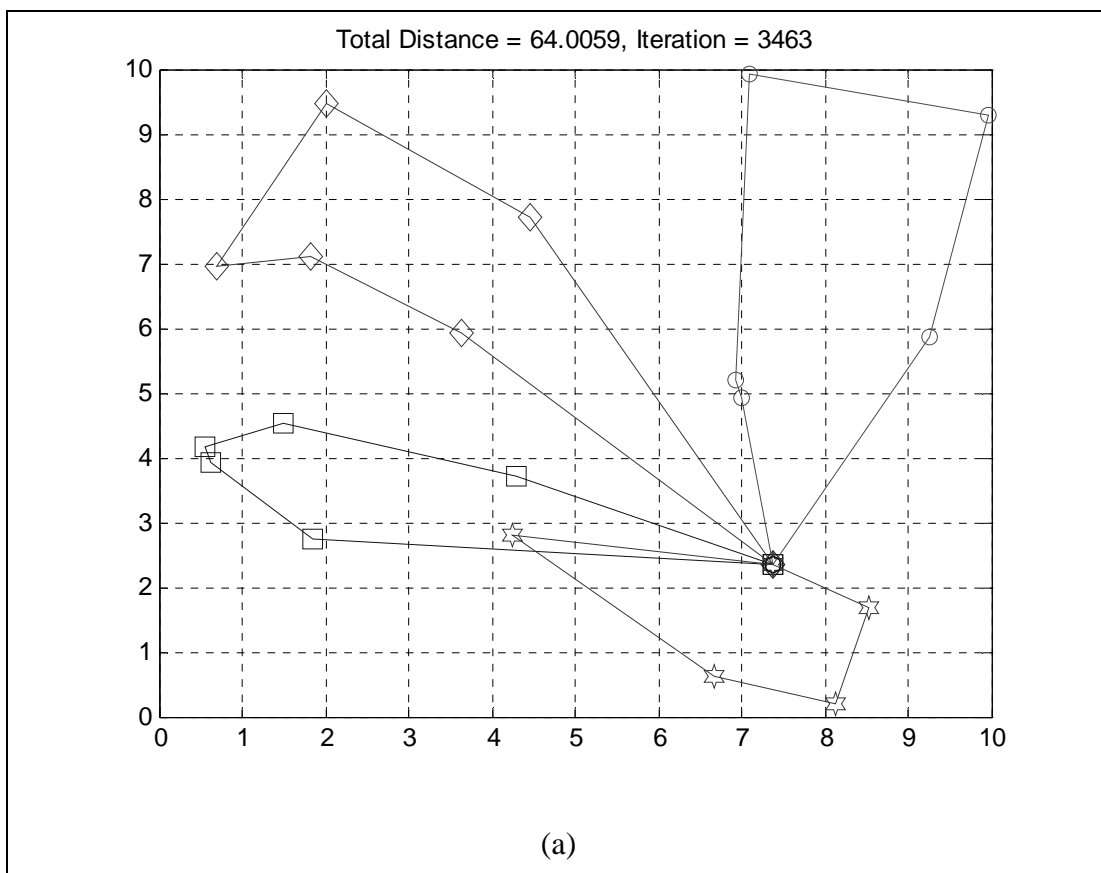

Figure 5.14 (a) and (b) Four trucks travel at minimum possible total distance. All locations visited.

To minimize the total distance, GA method is utilized to determine the assigned locations for each vehicle and to keep the travelled distance for these vehicles at minimum. Based on the algorithm's outcome, minimum total distance for four vehicles can only be achieved by the network configuration shown at fig.5.14a. The solution network design (fig. 5.14a) is based on the predetermined locations (see top left of the fig. 5.14b). The best solution history or the objective function (bottom right of fig. 5.14b) is the gradual reduction of the total distance at each iteration.

Scenario 2

In this scenario, transportation networks for 20 locations with four trucks are considered with a fixed start node. On randomly distributed locations, vehicles are assigned to specific locations by the GA algorithm to minimize the total travelling distance of the vehicles.



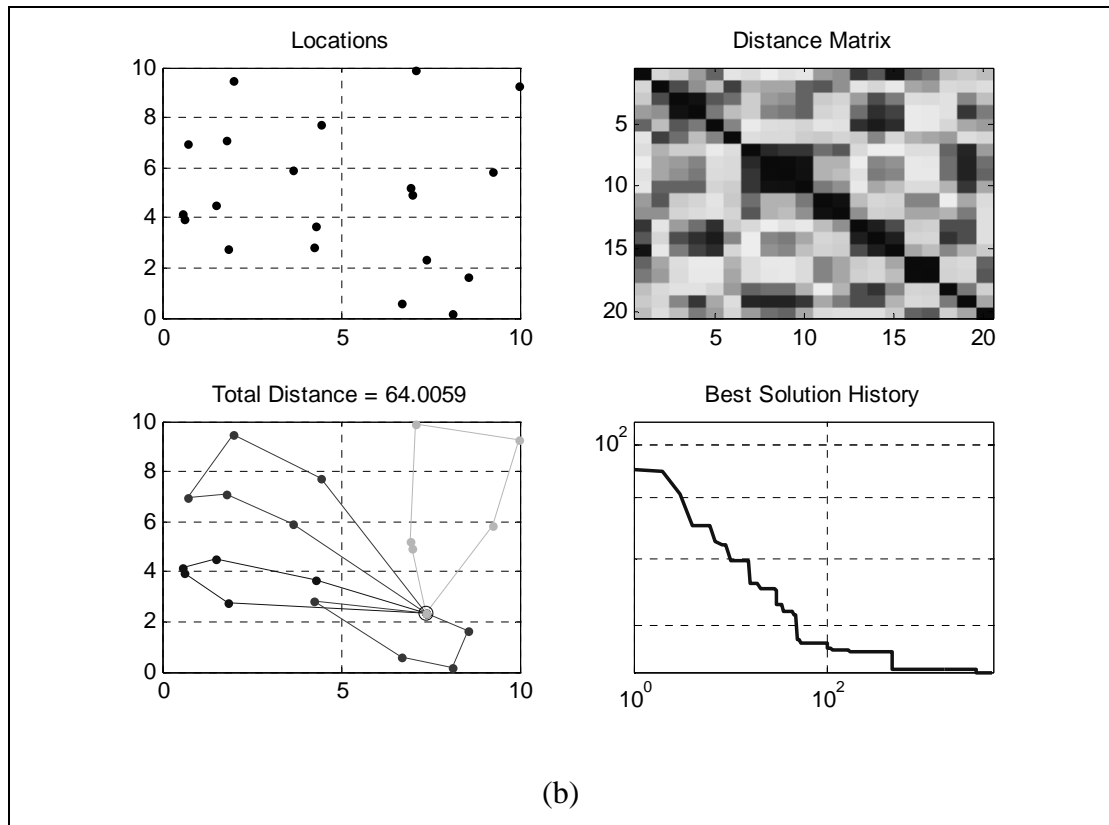

Figure 5.15 (a) and (b) Four trucks, starting from a fixed location, travel at minimum possible total distance. All locations visited.

A closed loop network for each vehicle has been generated. The total distance can only be minimized by the configuration shown at fig. 5.15a. At each iteration of the algorithm, the total distance reduces to a global minimum as shown at the best solution history (see bottom right of the fig. 5.15b).

Scenario 3

A scenario of a fixed start point with open ends for three trucks of 20 randomly distributed locations is considered. All locations are covered on the transportation network. Minimum total distance can only be achieved by the network configuration shown at the fig. 5.16a.

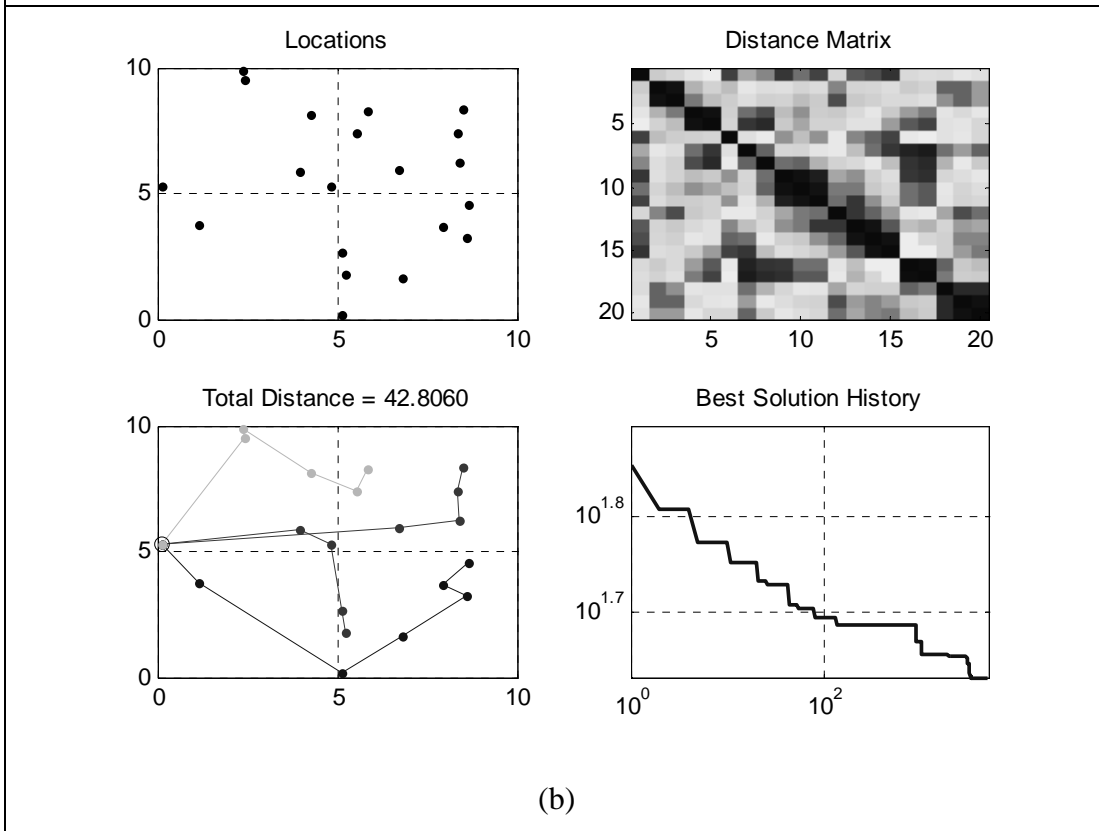
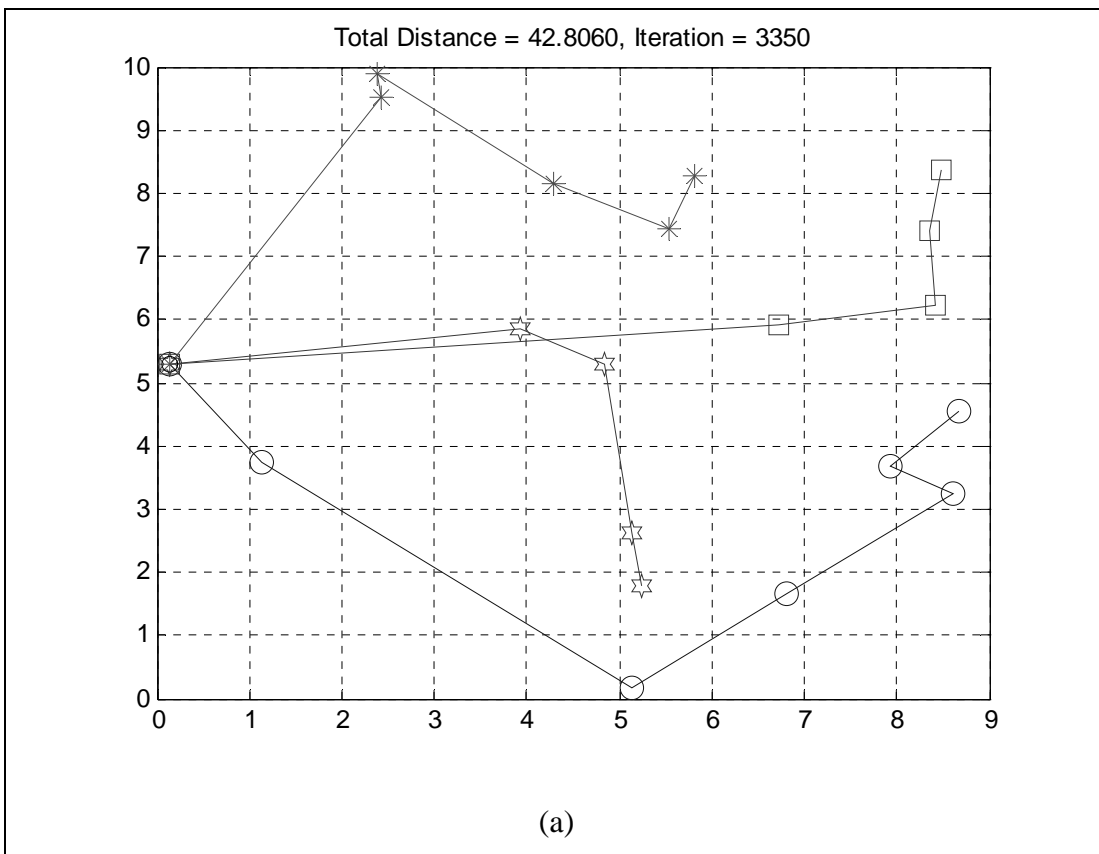
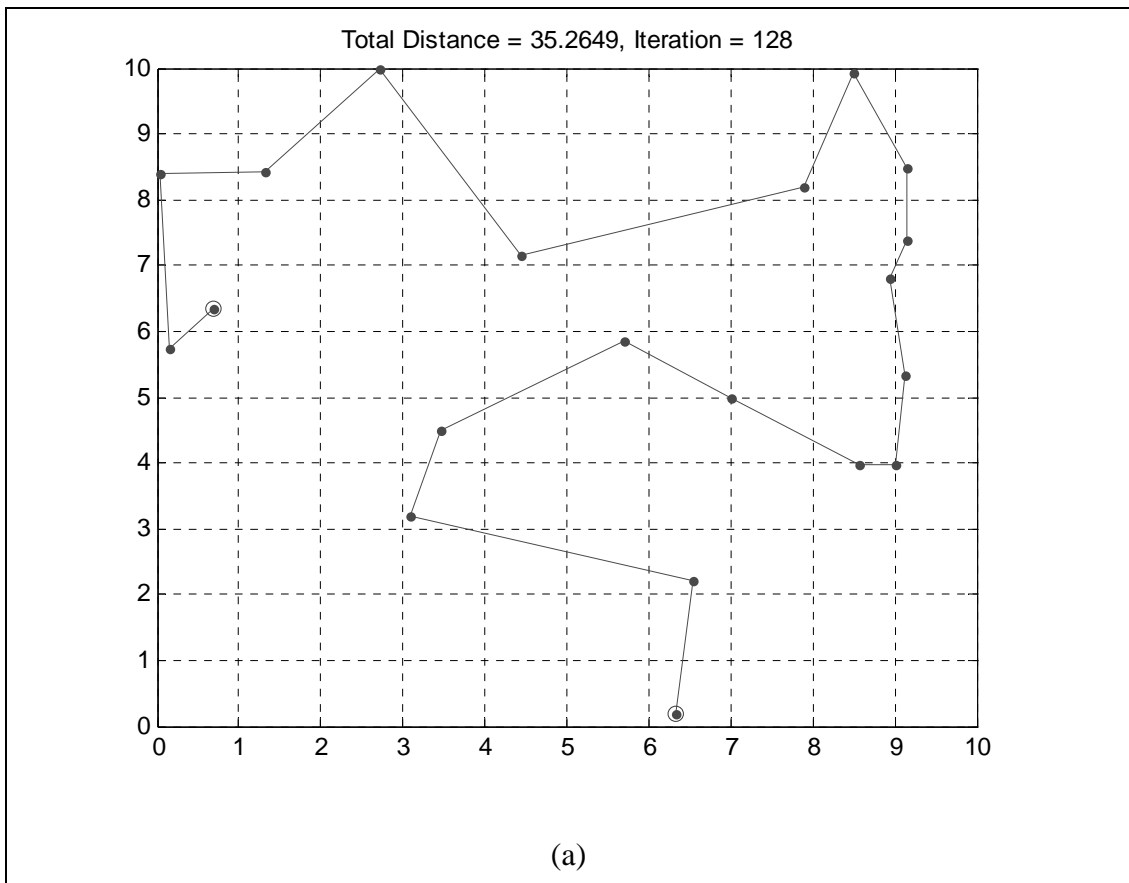

Figure 5.16 Four trucks, starting from a fixed location, travel at minimum possible total distance. All locations visited.

“Fixed start-open ends” configuration shown at the fig 5.16a provides the minimum possible total distance for all the vehicles. Other details of the configuration can be seen at the fig. 5.16b.

Scenario 4

This scenario covers the basic minimum total distance for fixed start and fixed end location for a travelling vehicle. Minimum total distance by visiting all the locations can only be achieved by following the route shown at the fig. 5.17a.



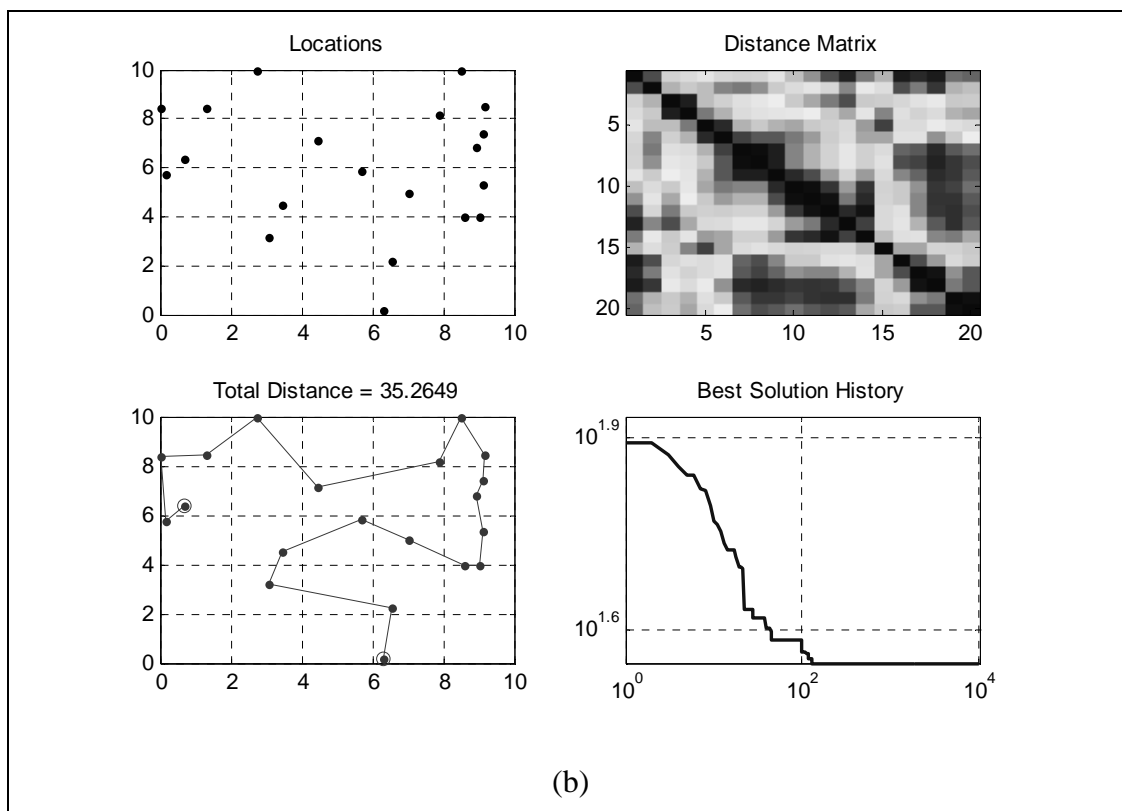

Figure 5.17 Minimum possible total distance by covering all locations on the route. 1 vehicle with a fixed start and fixed end locations.

All locations are visited with a minimum total distance. Other details of the configuration can be seen at the fig. 5.17b.

Scenario 5

Another technique is utilized in this scenario to achieve the minimum total distance. The CE method is used to solve the closed loop network design. City locations are randomly selected and the algorithm achieves minimum possible total distance (See fig. 5.18a). The best solution history diagram is shown in fig. 5.18b.

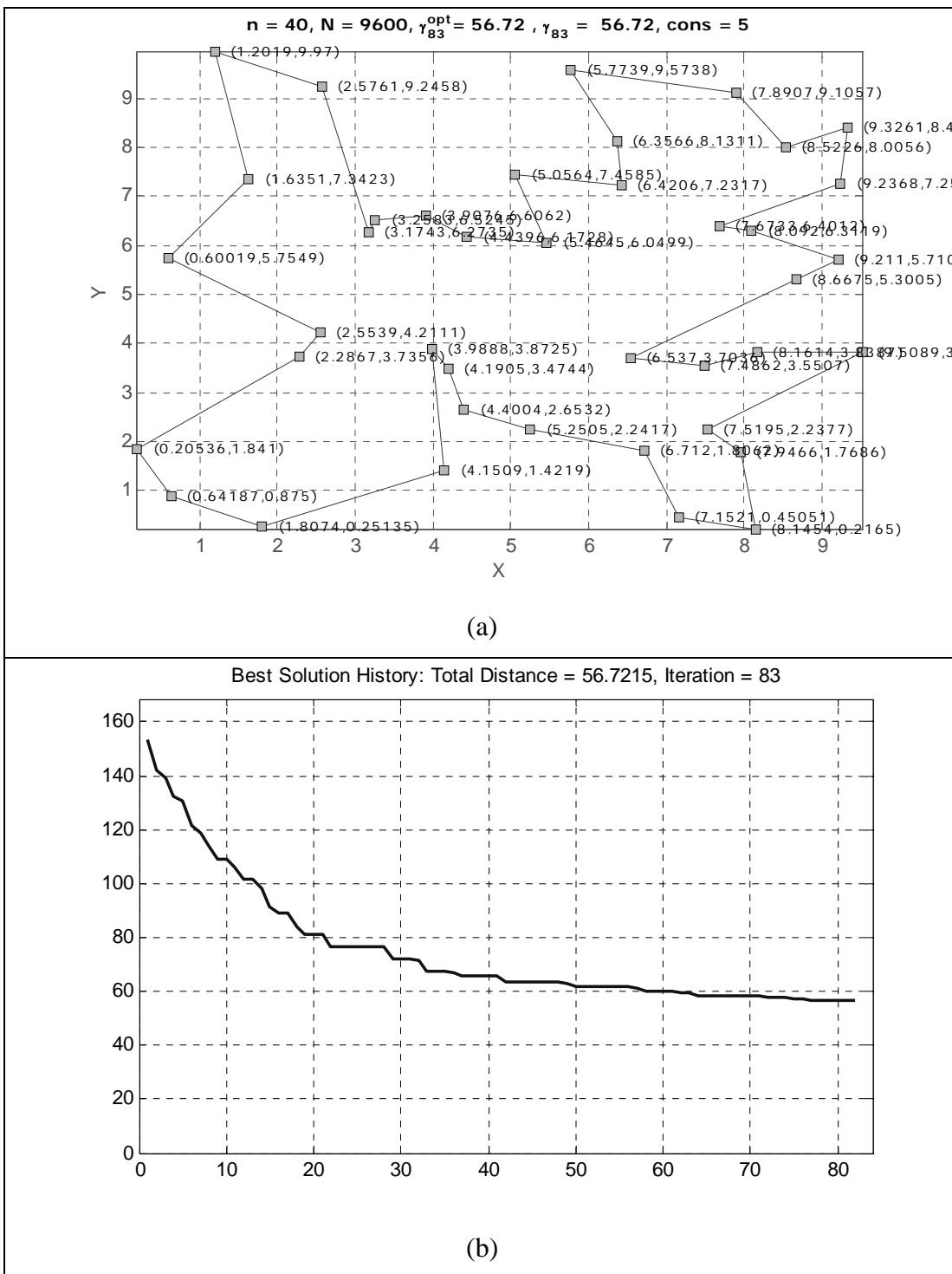

Figure 5.18 Minimum possible total distance by covering all locations on the route of a closed loop network and best solution history.

At each iteration of the CE algorithm, total distance gradually reduces and optimal distance is achieved at the last iteration (See fig. 5.18b.). Transition probabilities matrix of CE method is shown at the fig. 5.19.

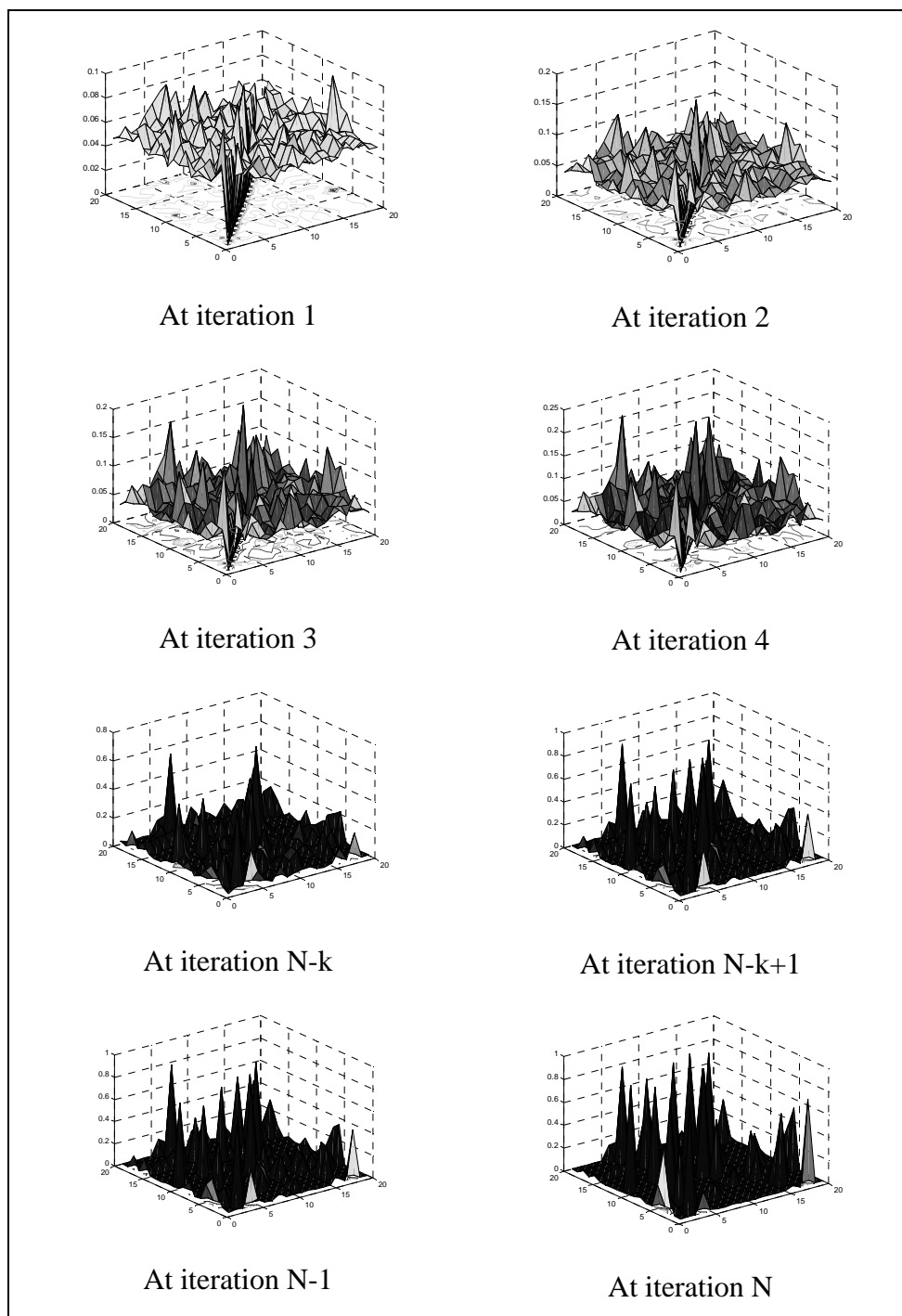

Figure 5.19 Transition probabilities matrix ($n \times n$)

In the dynamics of the CE algorithm, at each iteration, better p vectors (p^0, p^1, \dots) are created and each of these vectors are used to generate better z (z^0, z^1, \dots) values. Algorithm stops when z converges to a global optimum value z^* . Thus, the total

distance reduces gradually. Optimal solution was found at the last (N) iteration (See fig. 5.19, and fig. 5.18a, 5.18b), and optimal tour obtained at the end of the last iteration.

Fig. 5.19 depicts the dynamics of CE algorithm at each iteration, as sequence of matrixes for the shortest distance problem with generated matrixes of $\hat{P}_0, \hat{P}_1, \hat{P}_2, \dots$ where, at the last iteration optimal tour (minimum possible distance) has been reached.

5.2.4 About Optimal Solutions by Heuristics Methods

In this section, some selected algorithms for solving shortest distance problems coded with the same programming languages (C++ and Matlab®) have been tested. Selected algorithms for solving shortest distance problems are namely; CE for cross-entropy method, GA for genetic algorithm, NN for nearest-neighbor method. These algorithms are tested on an Intel® Core™2 Quad CPU Q6600 @2.4GHz and 3.5GB RAM personal computer with MS Windows® XP™ Professional operating system. (See Table 5.2) It is important to note that with different types of problems and constraints, selected algorithms (CE, GA, and NN) will have dissimilar returns of optimal values (or depending on the type of problem, no return at all) and varying CPU times. In such cases, the *reliability* and *stability* of an algorithm becomes crucial while obtaining optimal solutions among different kinds of problems with different constraints.

Table 5.2 The best solution obtained by the heuristic methods.

Complexity of the problem (Matrix – Rows x Columns)	CE		GA		NN	
	Result	Ave. CPU Time (sec.)	Result	Ave. CPU Time (sec.)	Result	Ave. CPU Time (sec.)
50 x 50	55.9	9.6	58.4	107.4	64.0	0.03
100 x 100	81.0	136.1	84.5	198.4	89.7	0.13
150 x 150	102.7	1303.7	103.3	283.7	106.8	0.33

Table 5.2 shows *output comparison* of tested heuristic methods, namely Cross Entropy (CE), Genetic Algorithm (GA), and Nearest Neighbor (NN). Matrix probabilities (nxn) generated randomly for testing purposes. Since the aim is to obtain the minimum value for a discrete function with constraints,

$$x^* = \min_{x \in D \subseteq X} f(x)$$

the lower the result, better the algorithm's performance. The method with a lower value is better. (See Fig. 5.20, 5.21, 5.22)

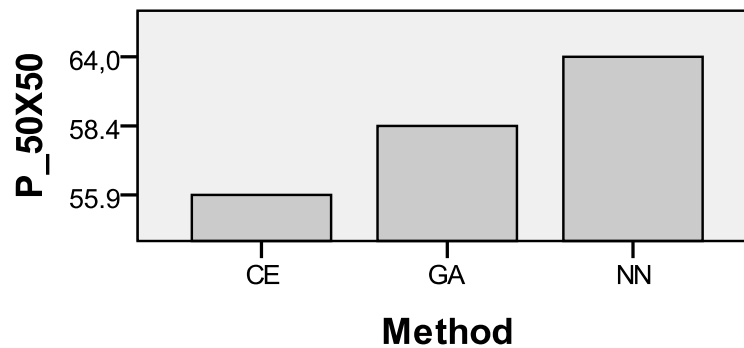

Figure 5.20 Optimal solution for a problem with 50X50 Matrix probabilities

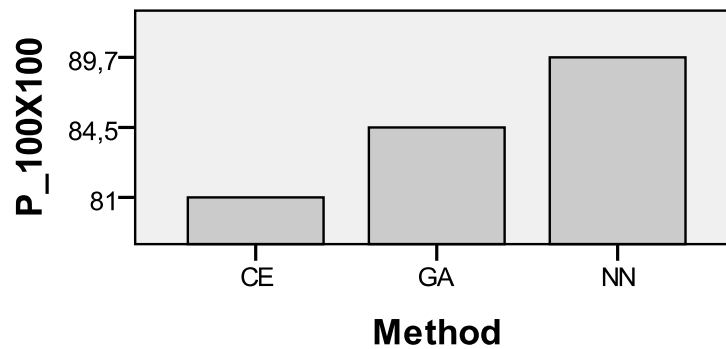

Figure 5.21 Optimal solution for a problem with 100X100 Matrix probabilities

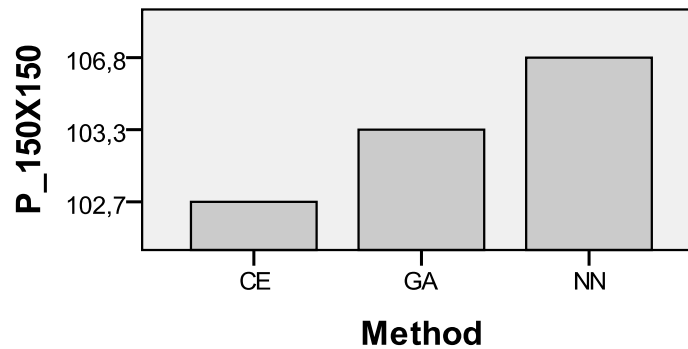

Figure 5.22 Optimal solution for a problem with 150X150 Matrix probabilities

Interestingly, the NN method seems to provide results so much faster than the other methods do, however it traps into local optimal all the time and does not give desired optimal values for a given problem, though the NN method quickly gets closer to optimum values but not any further. As a result, the CE method outperforms all the other tested heuristic methods by finding minimum possible output value.

5.3 Quay Crane Operation Characteristics

Quay Cranes (QCs) play important role in container operations. QCs are responsible for loading and unloading operations of containers from/to vessels (See fig. 5.23). QC services containership by shifting on a rail to reach the assigned stowage within the same ship and to move from one ship to a successive ship once the first one has been completed (Bielli et al, 2006). Cranes have direct effect on the operational cost of container terminals and thus, they must operate smoothly and continuously. Usually loading and unloading operation of one container at terminals are expected to be completed in less than 2 minutes per quay and per container. Based on the operational characteristics of quay cranes, trailers must be available on time under the QC.

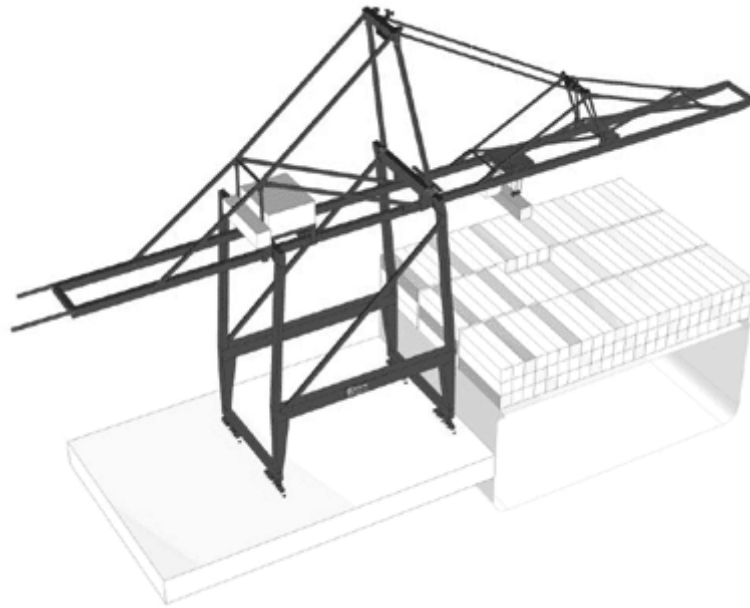

Figure 5.23 Quay crane (Source: Kalmar Industries 2009)

To unload a ship, one or several (even up to 5 or 6 for largest containerships of latest generation) quay cranes pick up containers from the ship and put them on shuttle trucks that move them to the assigned yard positions within the terminal storage area. (See fig. 5.24) To load a ship the quay crane unloads a container from a shuttle and puts it on the ship (Bielli et al, 2006).



Figure 5.24 Quay crane and various seaside operations. Source: Kalmar industries 2009

5.3.1 Quay Crane Characteristics

In this section, typical operational characteristics of quay cranes are examined. Table 5.3 shows typical time-dependent processes of a quay crane in operation. Depending on the capacity of the container ship, the average time for loading/unloading a single container to/from vessel varies. Typical unloading and loading operation of container takes about less than 2 minutes. For feeder vessel types, the average time is around 80-100 seconds. Quay cranes have six concurrent processes for unloading/loading operation of a container. These processes are namely “coupler”, “lifting”, “translation”, “going down”, “release”, and “return”. The “return” process consumes the most of the operational time. Next, depending on the size of a container ship, the second most time consuming processes are “lifting” and “going down”. These small and time dependent values make the whole operational time for loading/unloading an entire vessel. Thus, the performance of a single quay crane operation directly affects the entire operational time.

Table 5.3 Quay-crane average operations time (s) per container (1 TEU). (Source: Caramia and Dell’Olmo, 2008)

Type of Operation	Load		Unload	
	Panamax	Feeder	Panamax	Feeder
Coupler (sec.)	9-13	9-13	9-13	-
Lifting (sec.)	18-24	12-16	18-24	-
Translation (sec.)	17-21	11-14	17-21	-
Going Down (sec.)	18-25	12-16	18-25	-
Release (sec.)	8-12	8-12	8-12	-
Return (sec.)	45-53	31-38	45-53	-
Average (sec.)	116-148	83-109	116-148	-

There are various types of quay cranes in operation at container terminals. These are namely “Single-trolley QC”, “Double-trolley QC”, “Tandem-lift QC”, and “Tandem double-trolley QC” (See figure 5.25). For smooth QC operation, containers must be available before the lifting process. Therefore, it is also a common practice to make available a buffer zone for a number of containers. Thus, QCs can operate without any interruptions or waiting for container availability. Table 5.3 shows brief information about QC types.

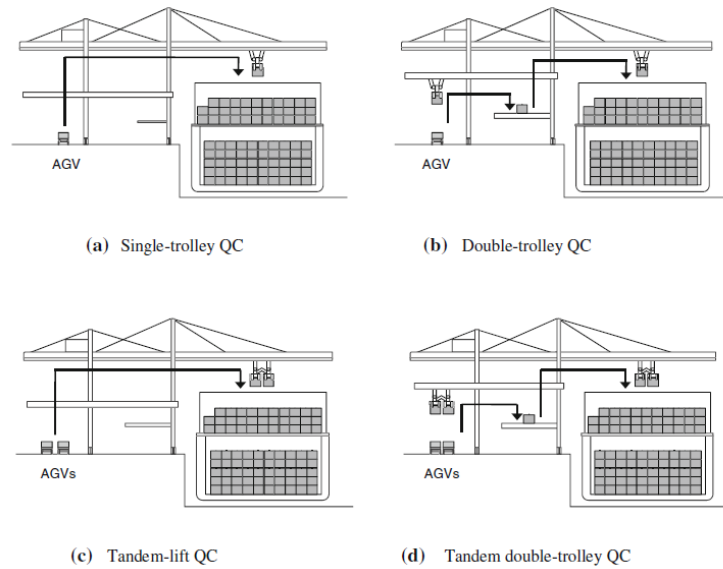

Figure 5.25 Various types of quay cranes (Source: Bae et al, 2009)

The most efficient type of QC is “Tandem double-trolley QC”, as it can carry two containers at a time with a container buffer zone on the QC. It can load about 75 containers per hour and it can discharge about 85 containers per hour at around 90 seconds. As this type of QC can load and unload containers quicker than the other types of QCs, it is important to supply, or make available, more containers on time for the Tandem double-trolley QC.

Table 5.4 Various types and productivity of quay cranes (Source: Bae et al, 2009).

QC types	Throughput (boxes/h)		Cycle time (sec.)	
	Discharging	Loading	Discharging	Loading
Single-hoist single-trolley QC	31	31	115.0	115.0
Double-trolley QC	42	38	83.7	91.5
Tandem-lift QC	62	62	115.6	115.6
Tandem double-trolley QC	85	75	84.3	92.1

Figure 5.26 shows typical QC processes for loading and unloading operation of containers.

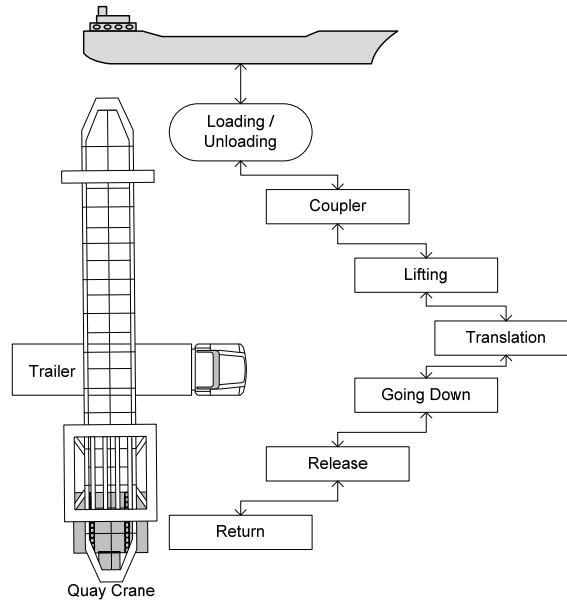

Figure 5.26 Typical QC processes

In order to visualize QC processes for unloading/loading operations of containers, a simulation model is developed by using Rockwell Arena software. The simulation model for QC operations is developed by taking into account of the model shown in figure 5.26. This model assumes that containers are always available on vessels board and the QC processes run concurrently without any interruptions. Figure 5.5 is a general model for QC discharge operation. The model than transferred to Arena simulation, see figure 5.27.

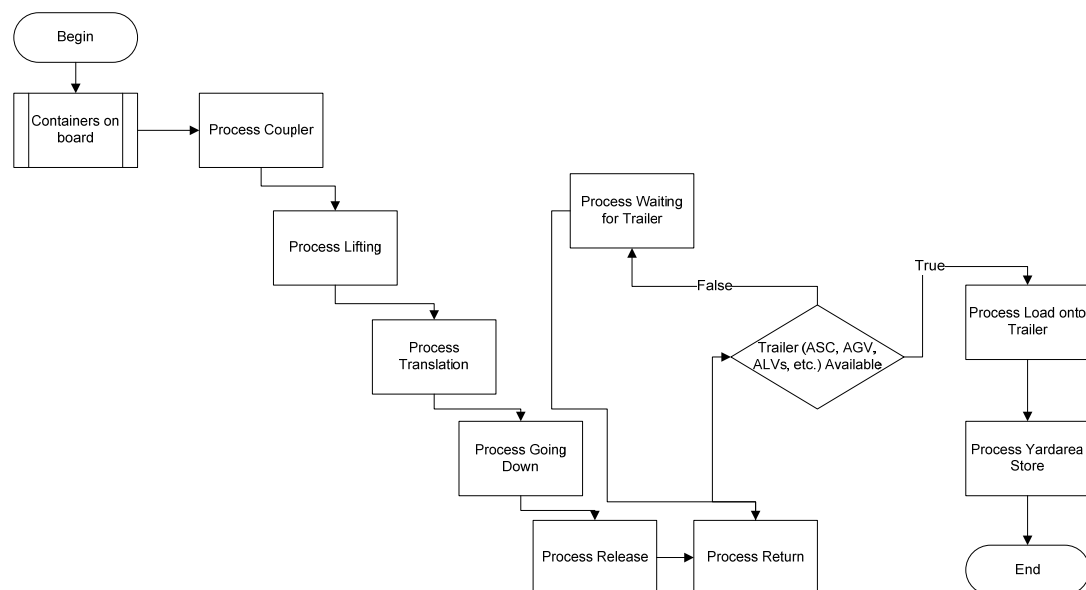

Figure 5.27 Quay Crane (QC) discharge operation

5.3.2 Quay Crane Characteristics and Processes

Simulations run on the supplied data or run on the data based on the estimated probability of similar real-world cases. As the aim is to simulate real-world cases, it is important to have knowledge about all characteristics of each process (See fig. 5.28).

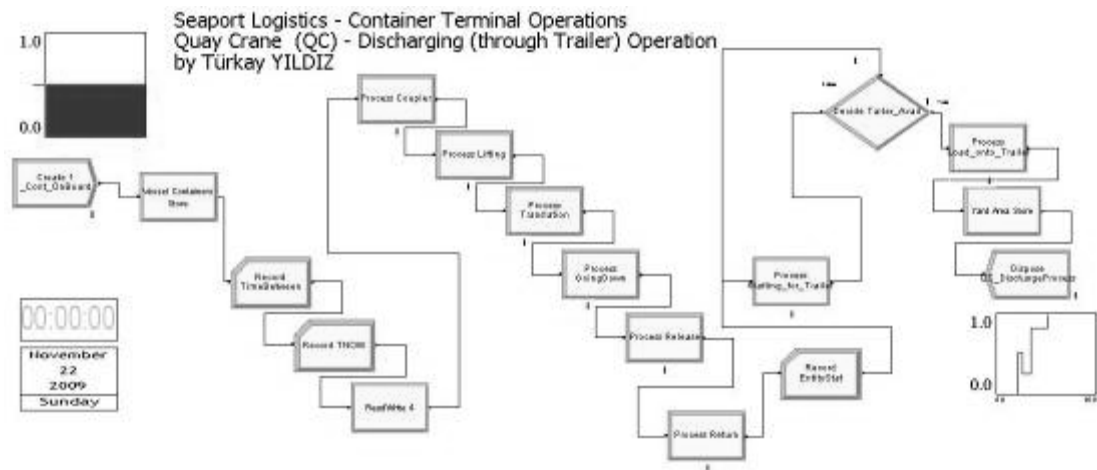
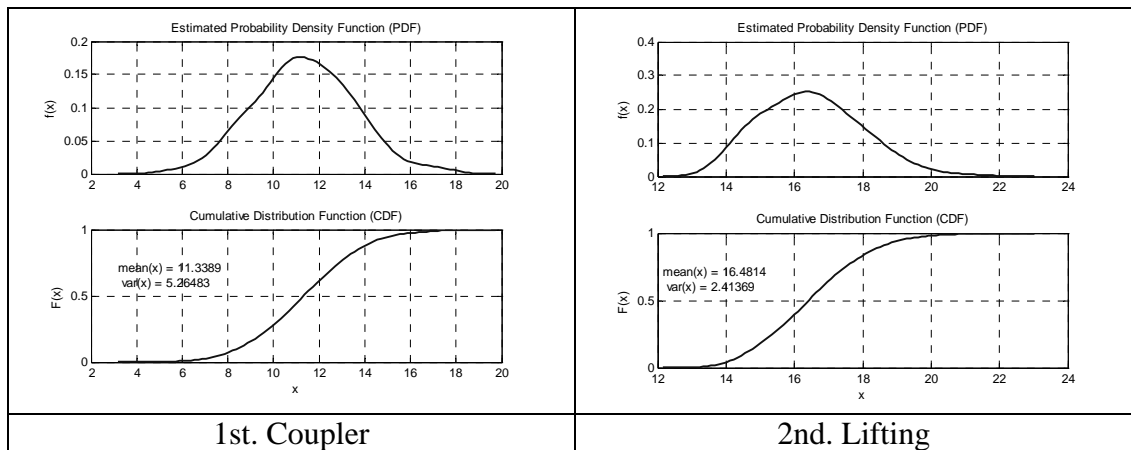
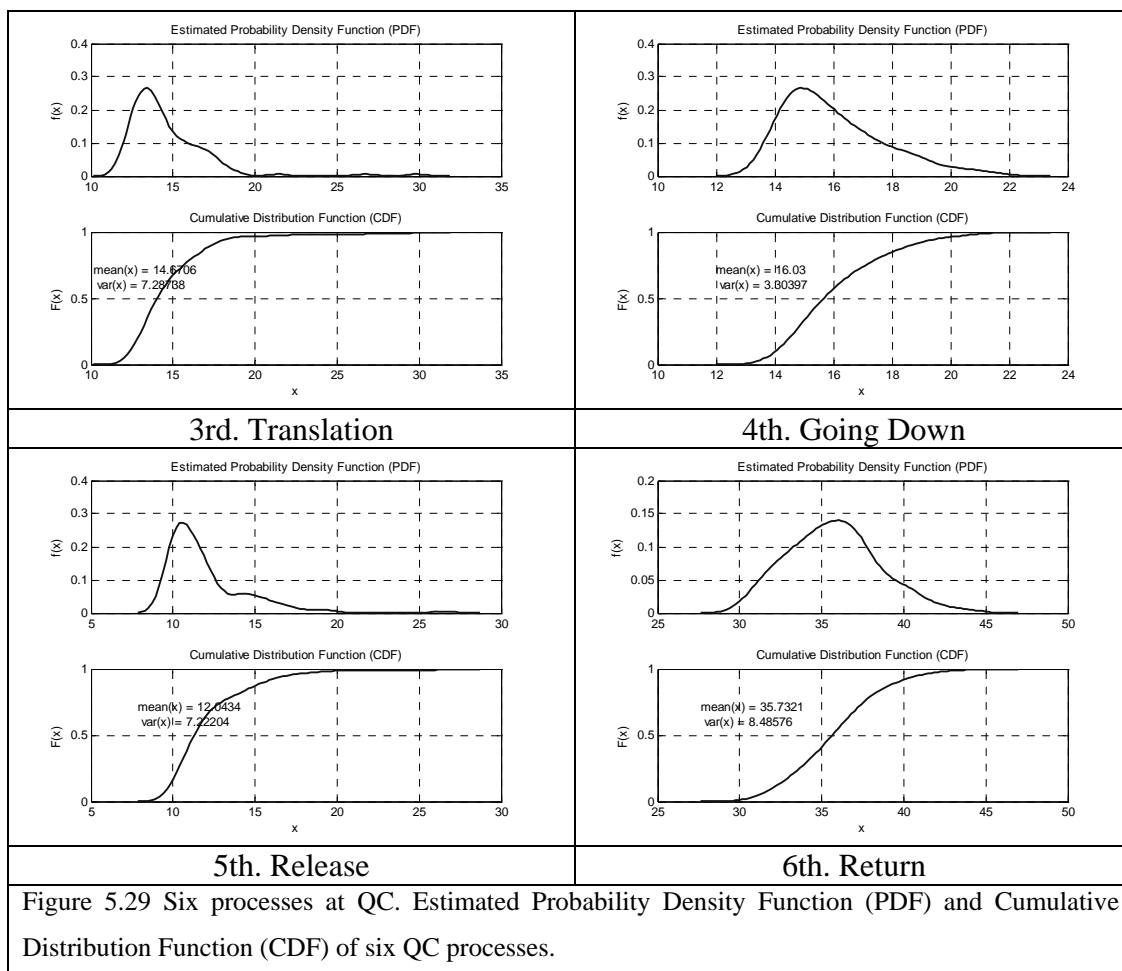

Figure 5.28 Arena simulation – Container discharging operation

In this section, characteristics of QC processes are considered. QCs have six processes, namely “coupler”, “lifting”, “translation”, “going down”, “release”, and “return”. The timing of all these six processes is based on different probability distributions (See figure 5.29).





For instance, “Coupler” process has characteristics of Normal distribution function.

Moreover, the normal distribution probability distribution function is defined as,

$$f_{pdf}(x) = \frac{1}{\sqrt{2\pi\sigma^2}} e^{-\frac{(x-\mu)^2}{2\sigma^2}}$$

and cumulative distribution function for coupler process is,

$$f_{cdf}(x) = \frac{1}{2} \left[1 + \operatorname{erf} \left(\frac{x-\mu}{\sqrt{2\sigma^2}} \right) \right]$$

Estimated probability density function and the cumulative distribution function can be seen on figure 5.30.

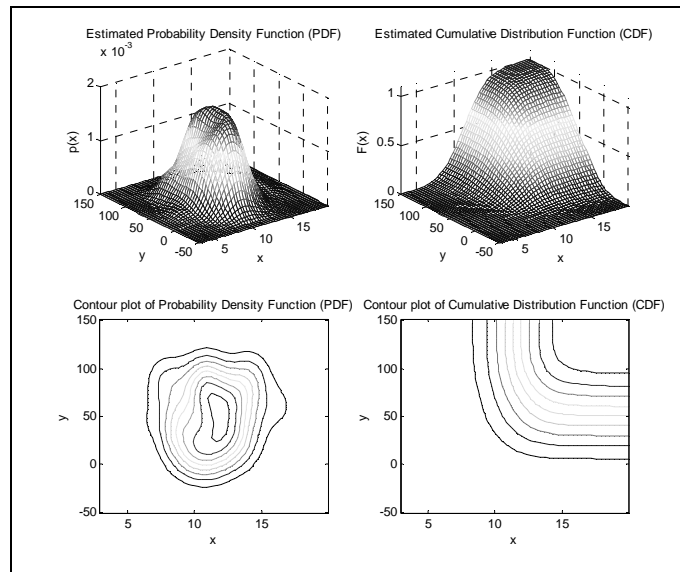

Figure 5.30 Coupler process characteristics

The normal distribution function has the best fitting for the coupler process of QC. On the other hand, “Lifting” process has different distribution characteristics, which fits better as a Rayleigh distribution (See figure 5.31). The Rayleigh distribution function is

$$f_{pdf}(x) = \frac{x e^{\left(\frac{-x^2}{2\sigma^2}\right)}}{\sigma^2}, x \in [0; \infty)$$

and Rayleigh cumulative distribution function for lifting process is

$$f_{cdf}(x) = 1 - e^{\left(\frac{-x^2}{2\sigma^2}\right)}, x \in [0; \infty)$$

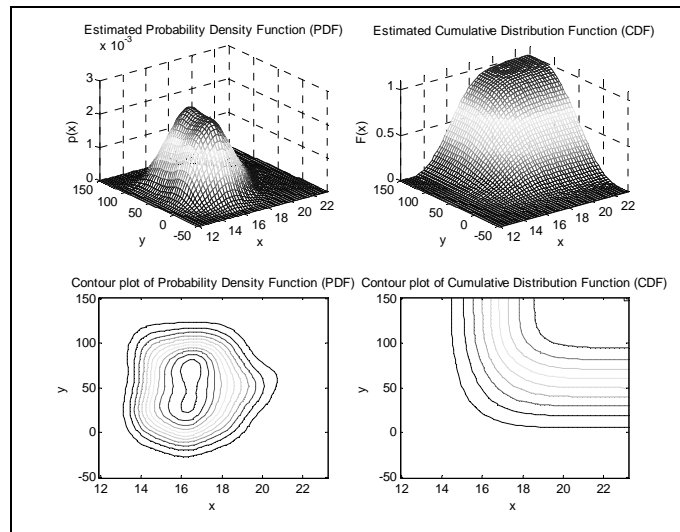

Figure 5.31 Lifting process characteristics

Other than the lifting process distribution characteristics, the “Translation” process of QC is considered as having a distribution that fits well as a log-normal distribution. The lognormal probability distribution function is

$$f_{pdf}(x) = \frac{1}{x\sqrt{2\pi\sigma^2}} e^{-\frac{(\ln x - \mu)^2}{2\sigma^2}}$$

and cumulative distribution function is

$$f_{cdf}(x) = \frac{1}{2} + \frac{1}{2} \operatorname{erf} \left[\frac{\ln x - \mu}{\sqrt{2\sigma^2}} \right]$$

Estimated probability function and cumulative density function for “Translation” process of QC operation is shown in figure 5.32.

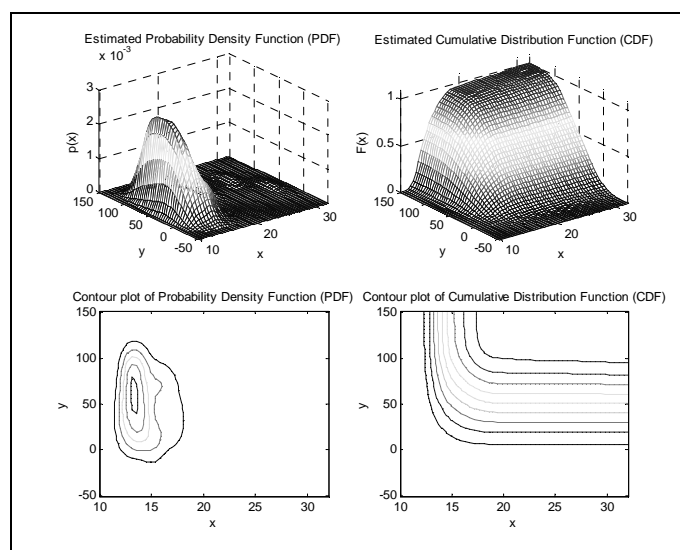

Figure 5.32 Translation process characteristics

Exponential distribution probability distribution function is

$$f_{pdf}(x) = \lambda e^{-\lambda x}, x \in [0, \infty)$$

cumulative distribution function is

$$f_{cdf}(x) = 1 - e^{-\lambda x}, x \in [0, \infty)$$

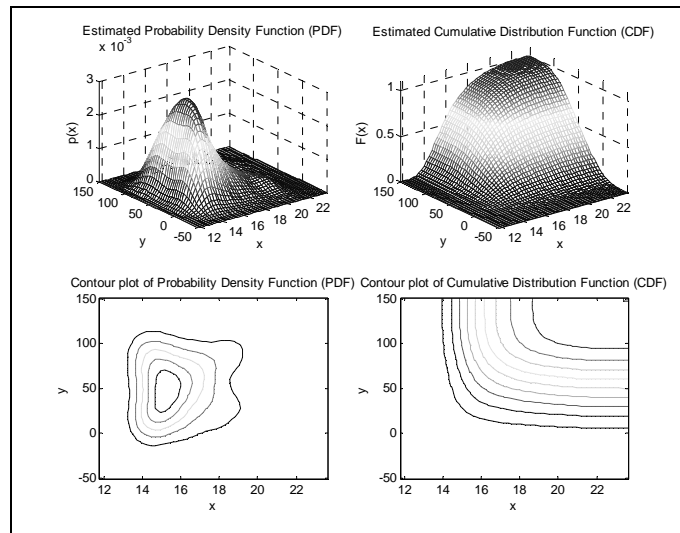

Figure 5.33 Going Down process characteristics

Chi-square probability distribution function is

$$f_{pdf}(x) = \frac{1}{2^{k/2} \Gamma(k/2)} x^{(k/2)-1} e^{-x/2}, x \in [0; +\infty)$$

Chi-square cumulative distribution function is

$$f_{cdf}(x) = \frac{1}{\Gamma(k/2)} \gamma(k/2, x/2), x \in [0; +\infty)$$

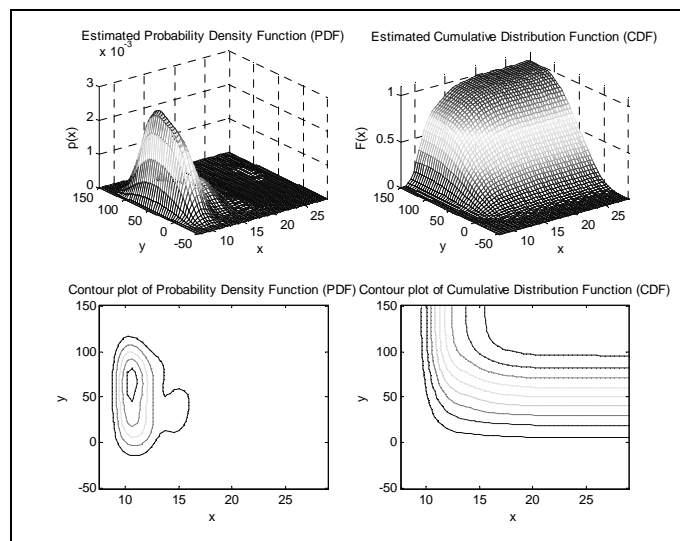

Figure 5.34 Release process characteristics

Normal distribution function is

$$f_{pdf}(x) = \frac{1}{\sqrt{2\pi\sigma^2}} e^{-\frac{(x-\mu)^2}{2\sigma^2}}$$

cumulative distribution function is

$$f_{cdf}(x) = \frac{1}{2} \left[1 + \operatorname{erf} \left(\frac{x-\mu}{\sqrt{2\sigma^2}} \right) \right]$$

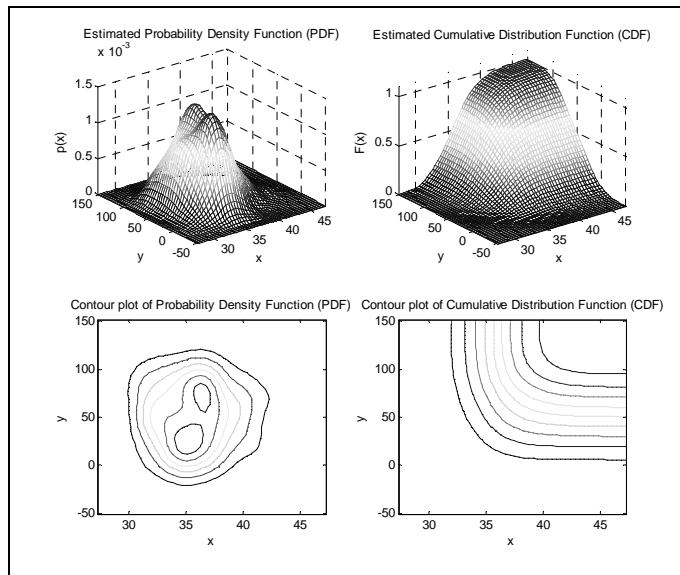

Figure 5.35 Return process characteristics

Estimated probability density functions of each process play important roles at simulation models. Therefore, before constructing a simulation model, it is a necessary step to investigate all characteristics information of every process (See figures 5.33, 5.34, 5.35).

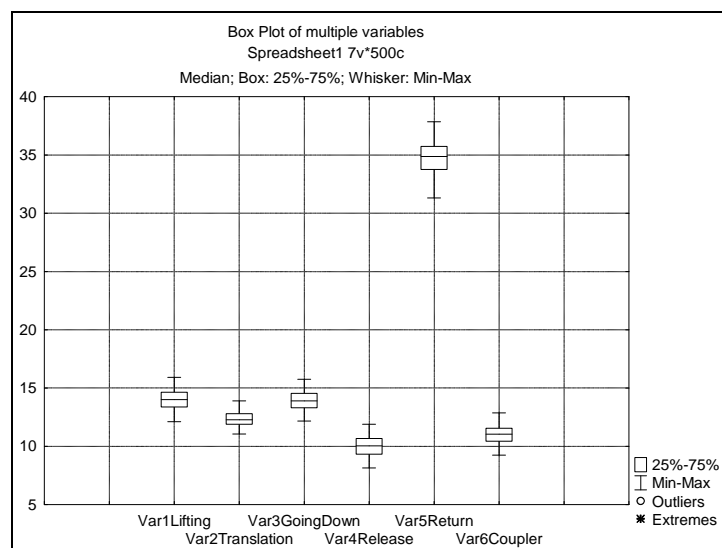

Figure 5.36 Box plot of QC processes

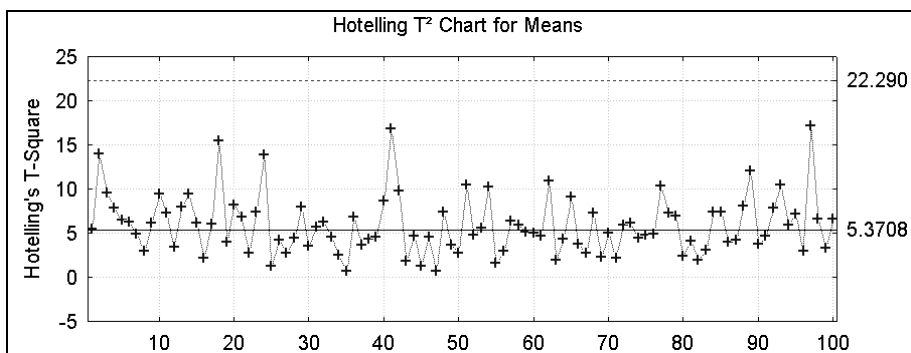

Figure 5.37 Multivariate analysis of QC processes

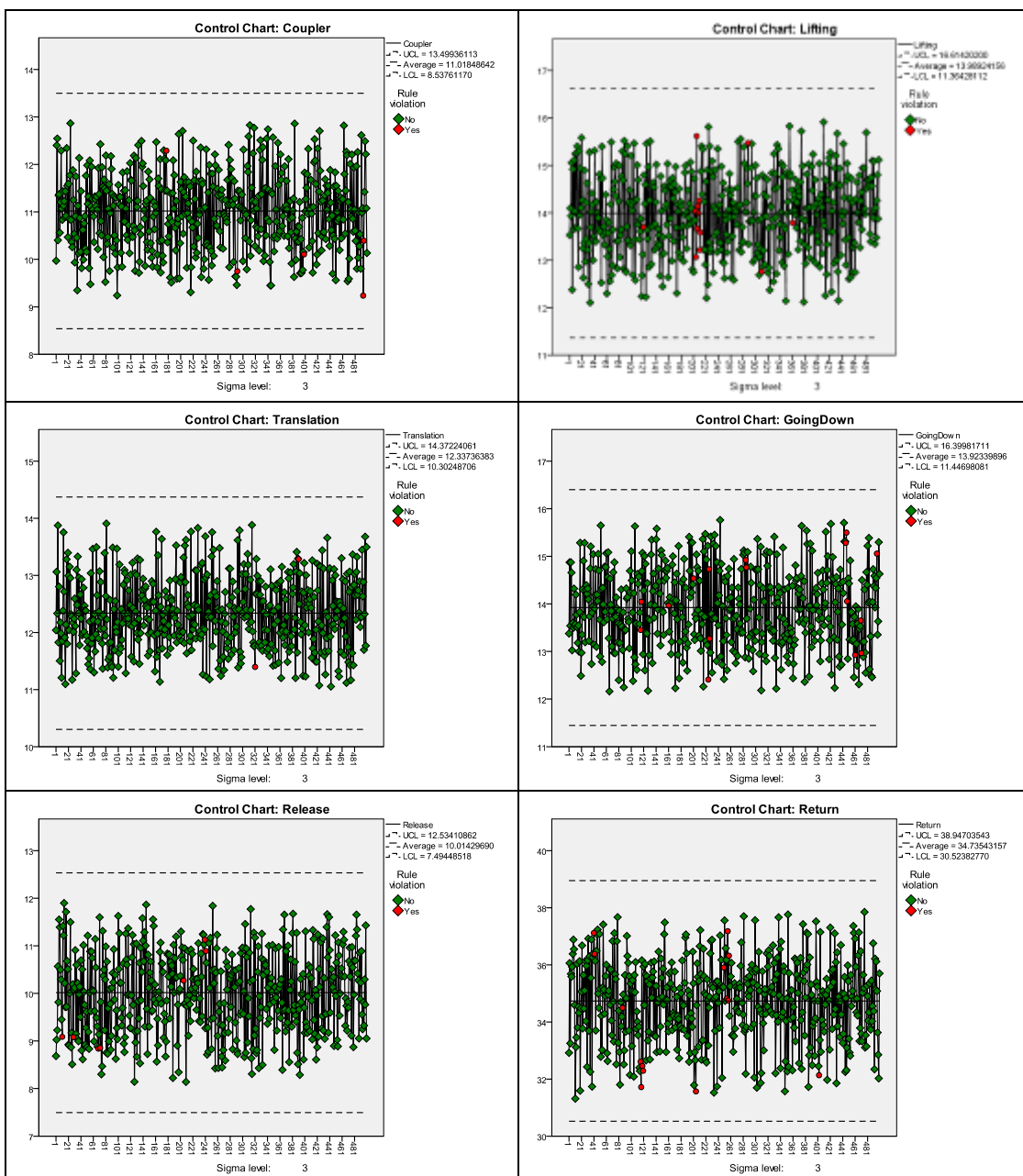

Figure 5.38 Raw time data of QC processes

5.3 Storage Yard Operations and Simulation

One of the important areas of terminal operations is the storage yard operations. Yard operations cover relatively long distances and wide areas at CTs. Because these operations cover long distances and wide areas at CTs, operations planning and task distributions among trailers for loading and unloading of containers at specified yard blocks need to be carefully designed. Typical yard trailer operation begins with QC's lift of a container on vessel's board and its loading onto the trailer. Figure 5.39 shows typical processes and their relations with the other processes of yard trailer operation.

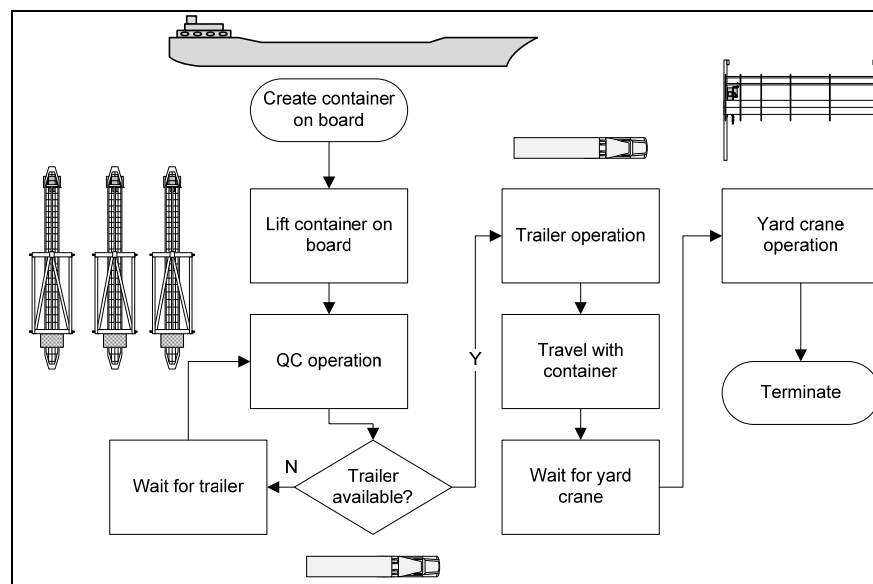

Figure 5.39 Trailer operations

Yard trailer operations are expected to be in a harmony to improve service quality and to reduce total operational costs. Therefore, yard trailers must be available on time under the QC. Moreover, after a short travelling, the trailer arrives transfer point of yard block with an available yard crane. The trailer assigned to the yard block needs to be available on time and yard crane must lift container from trailer on time without a delay.

To visualize the effects of yard operations for the loading and unloading operations, a simulation has been developed. Typical processes involved in trailer-yard operations put into the Rockwell Arena simulation software and the simulation shown in figure 5.40 run successfully.

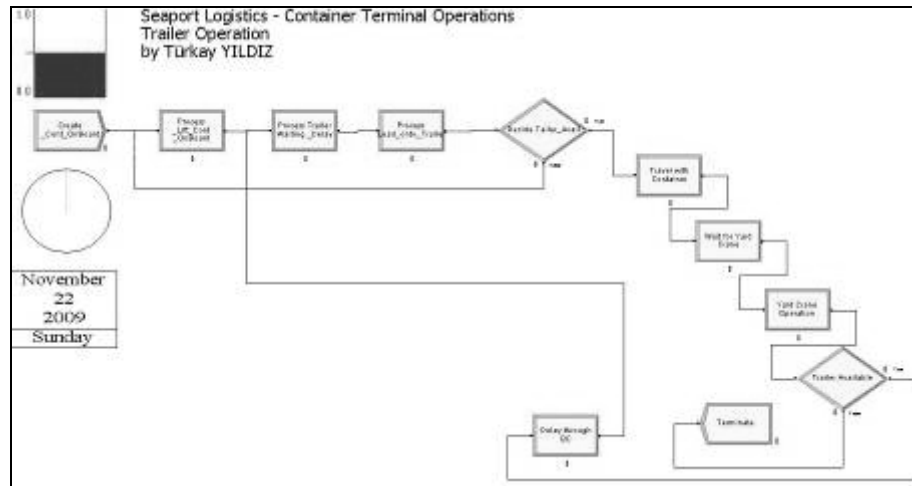

Figure 5.40 Trailer operation modeled in Rockwell Arena simulation software

Unexpected delay times have adverse effects on the yard operations. As it can be seen from the figure, 5.40 and 5.41, processes are connected concurrently and thus container loading/unloading depends on all the other processes of the system. Thus, small inoperative parts have negative effects on the total operation.

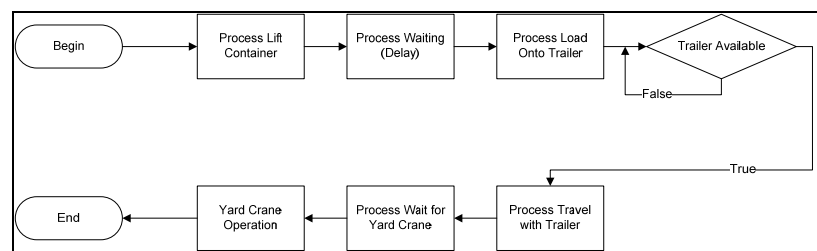

Figure 5.41 Trailer operation at yard area

There can be various designs for yard operations depending on the geographical location of container terminal and the physical constraints of the terminal. Usually a storage yard is divided into rectangular regions, which are called storage blocks, yard blocks, or blocks. A typical block at container terminals has seven rows. Six of these rows are used for storing containers in columns and the seventh row is used for yard trailer/truck's passing. Typically, each row at yard block consists of twenty 20-ft container stacks (Murty et al, 2005). Figure 5.42 shows container stacks and yard block with unmanned gantry cranes.



Figure 5.42 Unmanned gantry cranes (RTGs) at yard area. Source: Kalmar industries 2009

Operations in the storage yard are more flexible than quay crane operation. In a storage yard, yard gantry crane, top-pick loader, or straddle carriers are used to stack containers. Primarily yard gantry cranes carry out the container stacking procedure. The yard gantry cranes operate similarly to the quay cranes, in that a suspended container carriage is used to place and to retract containers (Bielli et al., 2006).



Figure 5.43 Unmanned straddle carrier/stacking crane at yard area. Source: Kalmar industries 2009

Yard gantry cranes are responsible for container stacking procedure. On the other hand, yard trailers, straddle carriers, AGVs, or trucks are responsible for container carriage from berth area (from/to QCs) to yard blocks, and vice a versa. Figure 5.43 shows typical unmanned straddle carrier operations at yard area. SCs operations procedure needs to be at productive and optimal levels at yard area operations.

5.4.1 Trailer and Intermodal Area Operations

Quay crane unloads ships and places containers on shuttle trucks, which move them to storage locations in the yard. This operation forms a closed loop that is traveled by shuttles servicing a ship (see Figure 5.44). Containers, which are stored in the storage yard, leave the terminal by input/output trucks to reach their final destinations.



Figure 5.44 Transfer area. Source: Kalmar industries 2009.

At “truck and train” area, mode changes occur. Containers are loaded onto trains at this area. This area’s operations are also similar to the operations at yard blocks area, instead the containers leaves the area on trains and empty trains are continuously supplied to carry containers, and vice versa. Figure 5.45 shows typical container terminal operations with five functional areas. These functional areas are namely Quay area, Transport area I, Yard area, Transport area II, and Truck and train area. Trucks, straddle carriers, ALVs can directly transfer containers between “Quay area” and “Truck and train area”.

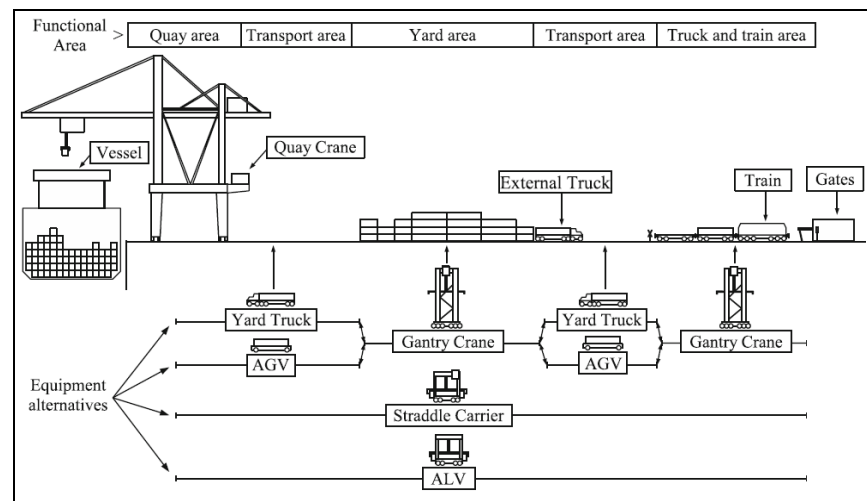

Figure 5.45 Container terminal operations. Source: Frank Meiser, 2009; Brinkmann 2005

Typical berth with quay cranes and yard with cranes configuration is shown in figure 5.45. In this configuration, there are predefined routes between yard and berth

areas. Containers loaded onto trailers at berth area are transferred to the specific yard block at the yard area using the transfer point at the yard block. See fig. 5.46.

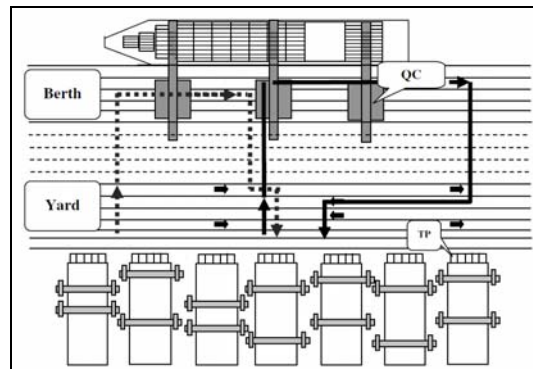

Figure 5.46 Container terminal – Berth and Yard routes (Source: Kim et al., 2006)

Another possible configuration of berth and yard area is made and run successfully with FlexSim CT simulation software as shown in figure 5.47. In this case, yard block are not perpendicular to the berth area, it is deigned as being parallel to the berth.

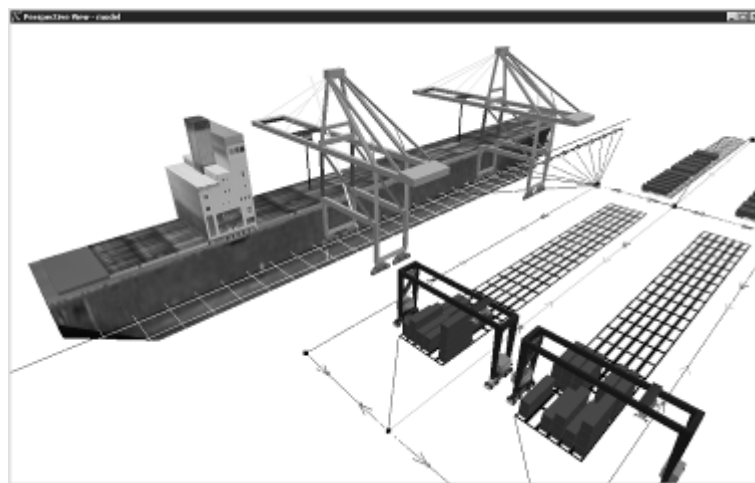

Figure 5.47 Perspective view from Flexsim simulation of container terminal berth and yard operations.

The simulation developed using FlexSim CT and run to visualize possible berth-yard operations. Figure 5.48 shows orthographic view of yard blocks with some containers stacked. Gantry cranes continuously operate and stores containers at yard blocks. Yard trailers can be forwarded to other yard blocks depending on the availability of gantry cranes on time. This storage procedure improves efficiency and productivity at container terminals.

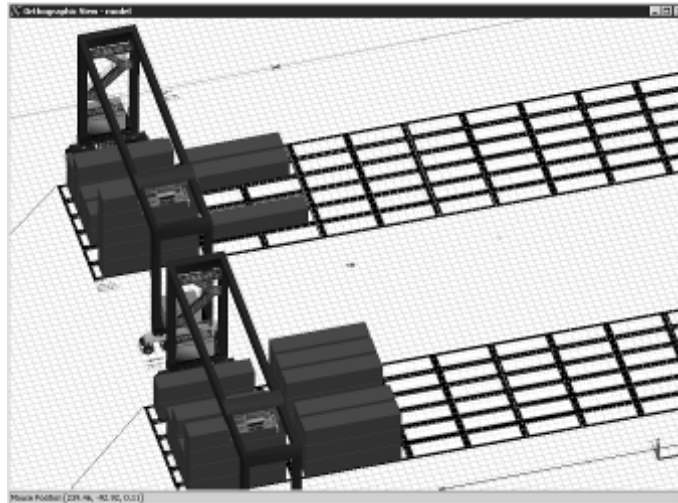

Figure 5.48 Orthographic view from Flexsim simulation of container terminal yard area operations.

Figure 5.49 and figure 5.50 shows statistical output of the simulation with one berth area with numerous container vessels arriving and several yard blocks to store containers temporarily.

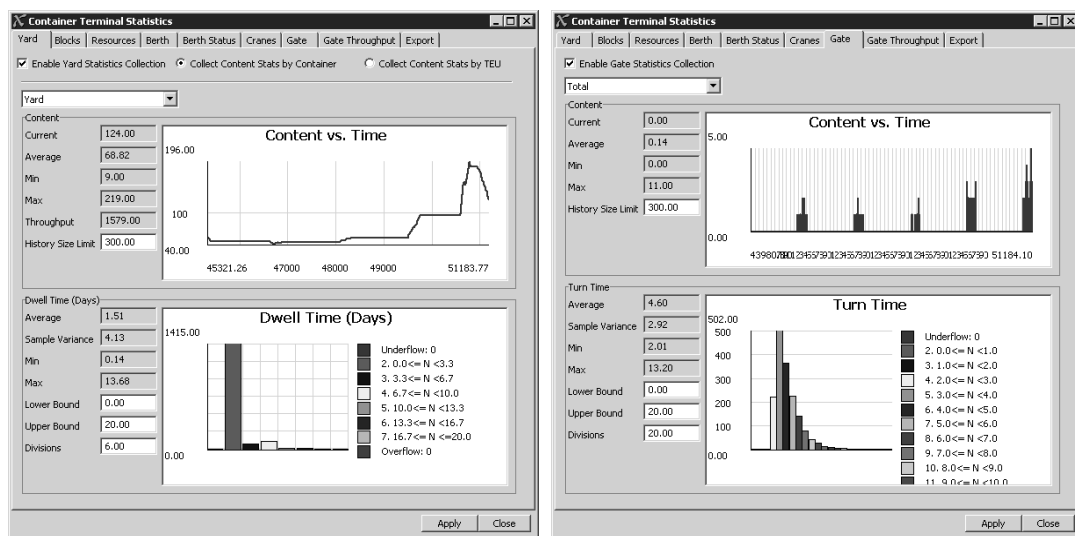

Figure 5.49 Yard and gate statistical figures.

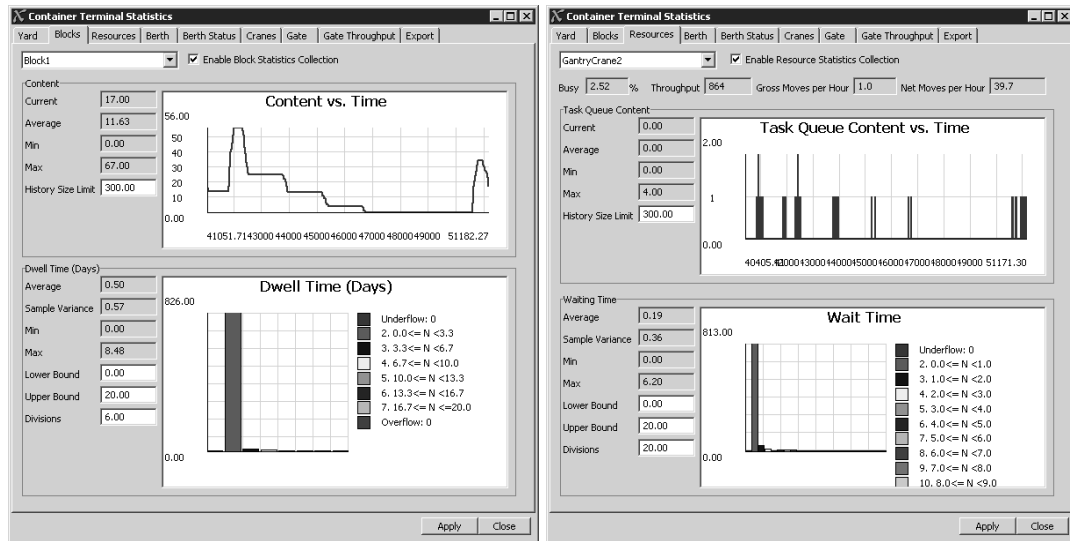

Figure 5.50 Blocks and resources statistical figures.

When a container vessel arrives, loading and unloading operations intensifies between yard and berth area. Therefore, activity level peaks occur. See figures 5.49 and 5.50.

5.4.2 Generalized Yard Operations Model and Solutions

In this section generalized yard operations model is considered. The aim is to reduce total cost (i.e. total time travel, etc.) of yard operations done by trailers (or AGVs, SCs, ALVs, trucks, etc) and their assigned yard blocks with limited capacity of availability. The objective function is to minimize the total cost of C_{ij} , travelling from location i to j where i is the trailer id and the j is the yard block id.

The model is represented by the Z function and the objective function is to:

$$\text{Minimize } Z = \sum_{k=1}^K \sum_{(i,j) \in A} C_{ij} x_{kij}$$

Subject to

$$\sum_{i=1}^n y_{ij} = 1, \quad j = 2, 3, \dots, n$$

$$\sum_{j=1}^n y_{ij} = 1, \quad i = 2, 3, \dots, n$$

$$\sum_{j=1}^n y_{1j} = K$$

$$\sum_{j=1}^n y_{i1} = K$$

$$\sum_{i=1}^n \sum_{j=2}^n D_j x_{kij} \leq U, \quad k = 1, 2, \dots, K$$

$$\sum_{k=1}^K x_{kij} = y_{ij} \quad \forall i, j$$

$$\sum_{(i,j) \in S \times S} y_{ij} \leq |S| - 1, \quad \text{for all subsets } S \text{ of } \{2, 3, \dots, n\}$$

$$x_{kij} = 0 \text{ or } 1 \quad \forall (i, j) \in A \text{ and } \forall k$$

$$y_{ij} = 0 \text{ or } 1 \quad \forall (i, j) \in A$$

- A fleet of M capacitated trailers (i=1)
- A set of target zones (yard blocks) (of size N-1), each having a demand D_j ($j=2, \dots, N$)
- A cost C_{ij} of traveling from trailer location i to yard block j
- The problem is to find a set of routes for delivering / picking up containers to/from the target zones at minimum possible cost.

The vehicle fleet is homogeneous and that each vehicle has a capacity of U units and variables:

$$x_{kij} = 1 \text{ if the trailer } k \text{ travels on the arc } i \text{ to } j, 0 \text{ otherwise}$$

$$y_{ij} = 1 \text{ if any trailer travels on the arc } (i,j), 0 \text{ otherwise}$$

The figure 5.51 shows a typical configuration of a container terminal with trailers (or trucks, SCs, ALVs, AGVs, etc) and yard blocks with their designated ids. The problem is to minimize the Z (the cost or time) by finding the matching clients (trailers) and servers (yard blocks) with their fixed costs and capacity constraints.

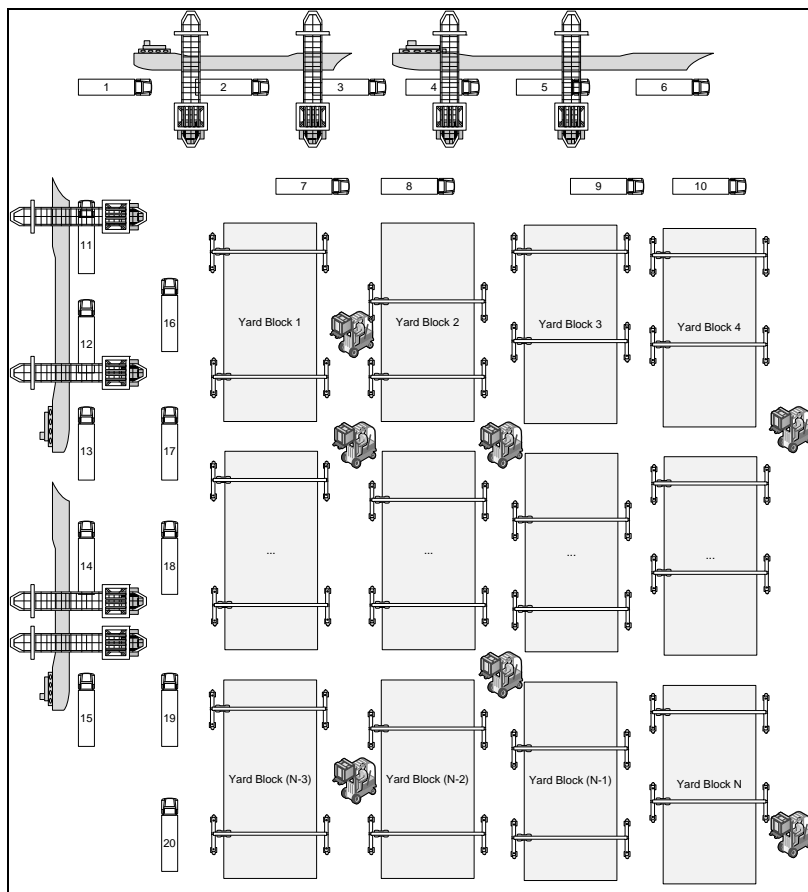

Figure 5.51 Yard area operations – N number of trailers and N numbers of yard blocks

Capacity availability distribution (data 1) of yard block is shown in figure 5.52. At a specific time fraction, yard blocks are not always available to serve unlimited number of yard trailers, otherwise, in front of yard blocks; there would be long trailer queues, which could cause deadlocks or traffic congestions. Therefore, in real case, each yard block has limited number of availability to serve yard trailers. This availability of yard blocks with gantry cranes at transfer points is called “capacity”. At a fraction of time, the distribution of availability to serve trailer capacities of yard blocks is shown at figure 5.52. On an average, a yard block is available to serve two or three trailers at a time.

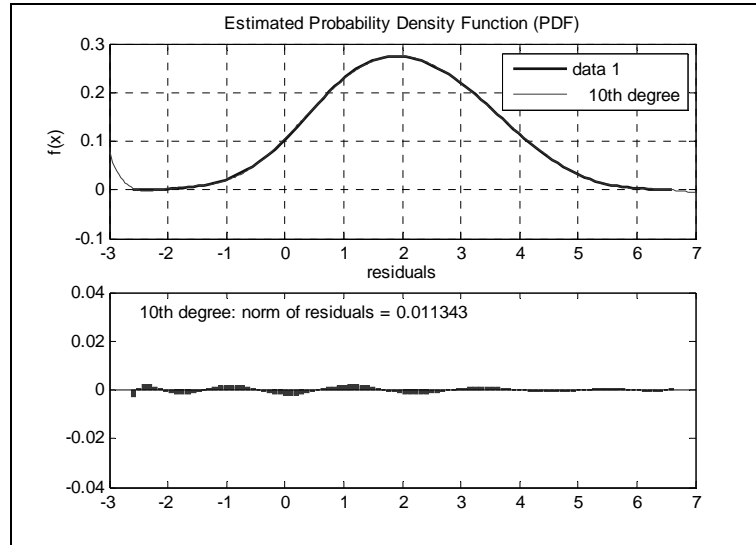

Figure 5.52 Capacity distribution with 10th degree polynomial fitting

The fitting function of the distribution is shown with 10th degree polynomial function of $\varphi_{Capacity}(\xi)$ with coefficient π :

Fitting capacity function:

$$\begin{aligned} \varphi_{Capacity}(\xi) = & \pi_1 \xi^{10} + \pi_2 \xi^9 + \pi_3 \xi^8 + \pi_4 \xi^7 + \\ & \pi_5 \xi^6 + \pi_6 \xi^5 + \pi_7 \xi^4 + \pi_8 \xi^3 + \\ & \pi_9 \xi^2 + \pi_{10} \xi^1 + \pi_{11} \end{aligned}$$

Coefficients:

$$\begin{aligned} \pi_1 &= 1.1042 \varepsilon - 007, \pi_2 = -2.9952 \varepsilon - 006, \pi_3 = 3.0598 \varepsilon - 005, \pi_4 = -0.00012295 \\ \pi_5 &= -0.00012672, \pi_6 = 0.0025424, \pi_7 = -0.0032526, \pi_8 = -0.02184 \\ \pi_9 &= 0.021301, \pi_{10} = 0.12331, \pi_{11} = 0.10569 \end{aligned}$$

$$\text{Norm of residuals} = 0.011343$$

The plot of residuals is also shown in figure 5.52. The small norm value of residuals (0.011343) guarantees that the 10th degree polynomial function fits well into capacity distribution (data 1).

The distribution of the “fixed cost” (See figure 5.53) based on the current locations and availability of trailers versus yard blocks’ capacity.

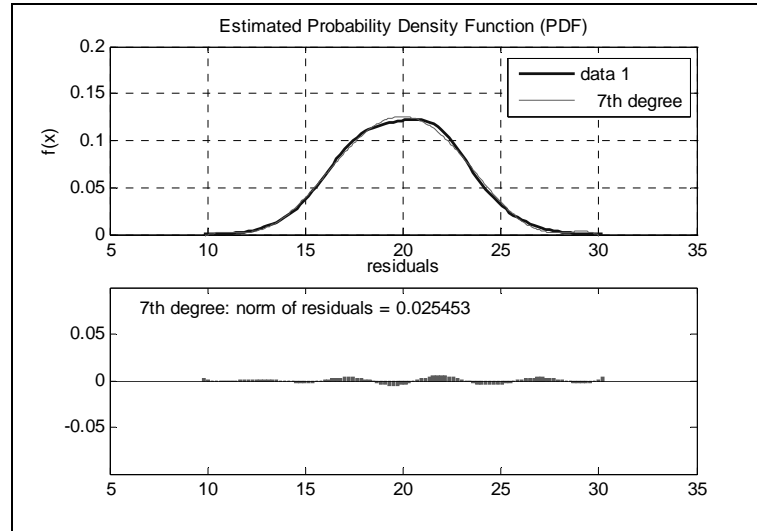

Figure 5.53 Fixed Cost distribution

The fitness function with 7th degree polynomial $\varphi_{Fixed\ Cost}(\xi)$ with a residual plot is shown in figure 5.53.

Fitting fixed cost function:

$$\varphi_{Fixed\ Cost}(\xi) = \pi_1 \xi^7 + \pi_2 \xi^6 + \pi_3 \xi^5 + \pi_4 \xi^4 + \pi_5 \xi^3 + \pi_6 \xi^2 + \pi_7 \xi^1 + \pi_8$$

Coefficients:

$$\pi_1 = -2.9937 \times 10^{-9}, \pi_2 = 1.1168 \times 10^{-7}, \pi_3 = 1.2136 \times 10^{-5}$$

$$\pi_4 = -0.0009765, \pi_5 = 0.028469, \pi_6 = -0.40733$$

$$\pi_7 = 2.8666, \pi_8 = -7.9317$$

$$\text{Norm of residuals} = 0.025453$$

The problem is based on the fixed cost, capacity, number of trailers (clients) and number of available yard blocks to serve. The problem is solved using IBM[®] ILOG's CPLEX on Matlab[®] software. The sample solution is calculated using 20 trailers (clients) and 20 yard blocks (servers). Therefore, the fixed cost is a square matrix of [20x20].

The output of CPLEX results are shown at table 5.5 through 5.10. CPLEX uses branch and cut algorithm for the solution of the problem. Table 5.5 shows the initial state of the CPLEX algorithm for the mixed integer programming (MIP) problem.

Table 5.5 Initial state of CPLEX solution

Tried aggregator 1 time.
MIP Presolve eliminated 1 rows and 21 columns.
Reduced MIP has 39 rows, 399 columns, and 779 nonzeros.
Reduced MIP has 399 binaries, 0 generals, 0 SOSs, and 0 indicators.
Presolve time = 0.00 sec.
Clique table members: 286.
MIP emphasis: balance optimality and feasibility.
MIP search method: dynamic search.
Parallel mode: deterministic, using up to 4 threads.
Root relaxation solution time = 0.00 sec.

Table 5.6 shows the initial near optimal value of 1197.0 at 56th iteration with relatively high gap of 5.48%.

Table 5.6 Initial CPLEX solution

Nodes			Cuts/				
Node	Left	Objective	IInf	Best Integer	Best Node	ItCnt	Gap
0	0	1131.4167	7		1131.4167	56	
*	0+	0		1197.0000	1131.4167	56	5.48%

The algorithm repeats the resolved problem at table 5.7 with further initializations. The result is 1171.0 at 190th iteration with a gap of 2.55% at table 5.8.

Table 5.7 Repeat of presolve

Repeating presolve.
Tried aggregator 1 time.
MIP Presolve eliminated 0 rows and 137 columns.
Reduced MIP has 39 rows, 262 columns, and 505 nonzeros.
Reduced MIP has 262 binaries, 0 generals, 0 SOSs, and 0 indicators.
Tried aggregator 1 time.
Represolve time = 0.00 sec.
Clique table members: 213.
MIP emphasis: balance optimality and feasibility.
MIP search method: dynamic search.
Parallel mode: deterministic, using up to 4 threads.
Root relaxation solution time = 0.00 sec.

Table 5.8 Solution table

Nodes			Cuts/				
Node	Left	Objective	IInf	Best Integer	Best Node	ItCnt	Gap
*	0+	0		1197.0000	1131.4167	112	5.48%
	0	0	1131.4167	7	1197.0000	112	5.48%
*	0+	0		1176.0000	1131.4167	112	3.79%
	0	2	1131.4167	7	1176.0000	112	3.79%
*	44+	15		1171.0000	1141.0833	190	2.55%
Cover cuts applied: 9							

Table 5.9 is the general overview of the processing time (0.03 second) of branch and cut algorithm of CPLEX solution.

Table 5.9 Processing time for achieving a solution

Root node processing (before b&c):	
Real time	= 0.03
Parallel b&c, 4 threads:	
Real time	= 0.00
Sync time (average)	= 0.00
Wait time (average)	= 0.00

Total (root+branch&cut)	= 0.03 sec.
Default variable names x1, x2 ... being created.	
Default row names c1, c2 ... being created.	

The final output and best available solution for achieving the minimal cost is shown at table 5.10.

Table 5.10 Final solution table

Minimum Cost: 1171.000000
Yard Block 3 serves the following AGVs, yard trailers, carriers: 2
Yard Block 5 serves the following AGVs, yard trailers, carriers: 17
Yard Block 8 serves the following AGVs, yard trailers, carriers: 13 18 19
Yard Block 9 serves the following AGVs, yard trailers, carriers: 5 11
Yard Block 11 serves the following AGVs, yard trailers, carriers: 9 15
Yard Block 13 serves the following AGVs, yard trailers, carriers: 14
Yard Block 14 serves the following AGVs, yard trailers, carriers: 3 10 20
Yard Block 17 serves the following AGVs, yard trailers, carriers: 12
Yard Block 18 serves the following AGVs, yard trailers, carriers: 4 7
Yard Block 19 serves the following AGVs, yard trailers, carriers: 6
Yard Block 20 serves the following AGVs, yard trailers, carriers: 1 8 16
Solution status = integer optimal solution

Based on the table 5.10 values, the best possible option for trailer and yard block association is shown in figure 5.54. The graph is the interpretation of the table 5.10, which client (yard trailer) is served by which server (yard block).

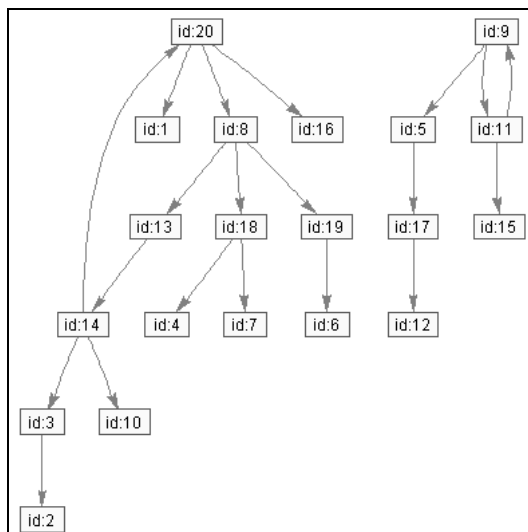

Figure 5.54 – The final yard operation graph for (20x20) matrix: the final map for minimum total cost

By following the developed methodology for yard area operations, various possible graphs for sample yard operations are also generated by utilizing CPLEX algorithm. See figures 5.55 and 5.56. The *yard_area()* function used in the calculation of associations is also shown at figure 5.57.

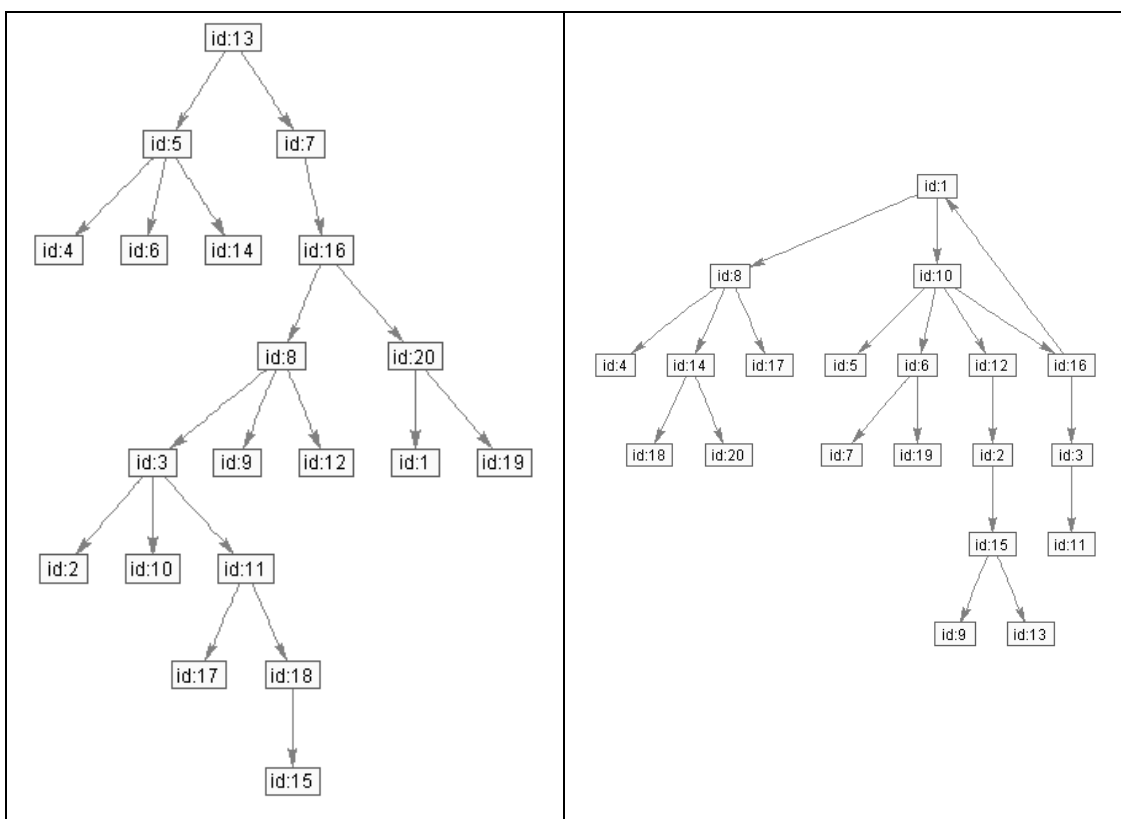

Figure 5.55 The two-solution graph of 20x20 matrix. (Clients x Servers or Trailers x Yard Blocks)

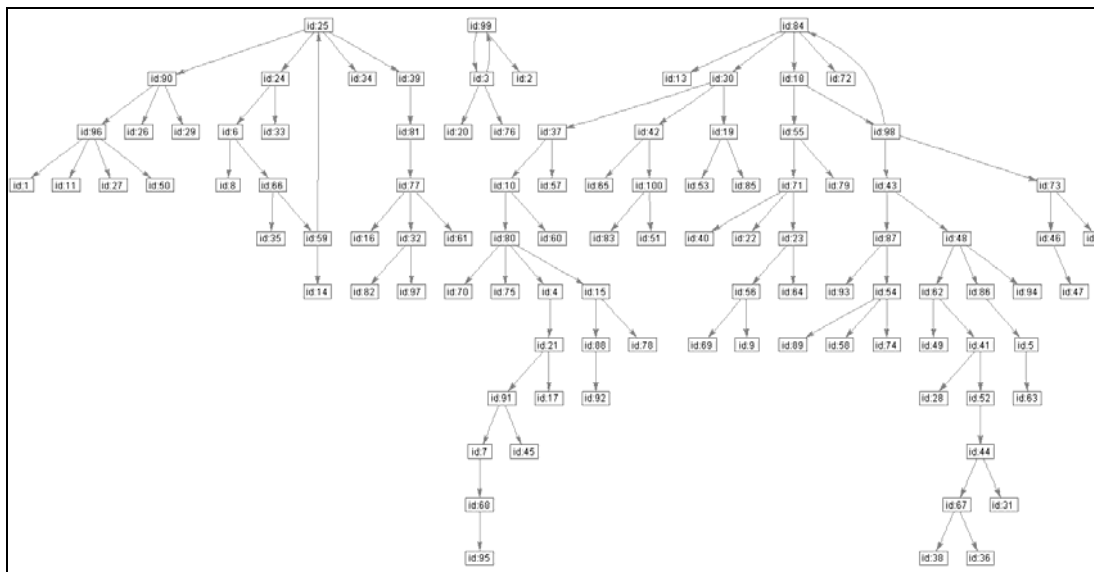

Figure 5.56 The solution graph of 100x100 matrix. (Clients x Servers or Trailers x Yard Blocks)

```

function yard_area ()
try
    capacity = inputdata ('capacity.dat');
    figure; gkdeb(capacity(:,1)); %PDF function
    fixedCost = inputdata ('fixedcost.dat');
    figure; gkdeb(fixedCost(:,1)); %PDF function
    cost = inputdata ('cost.dat');
    cost = reshape (cost', 10000, 1);
    nbLocations = length (capacity);
    nbClients = length(cost) / nbLocations;
    cplex = Cplex('fc');
    cplex.Model.sense = 'minimize';

    obj = [fixedCost;cost];
    lb = zeros (nbLocations + nbLocations*nbClients, 1);
    ub = ones (nbLocations + nbLocations*nbClients, 1);
    ctype = char (ones (1, (nbLocations + nbLocations*nbClients))*('B'));

    cplex.addCols(obj, [], lb, ub, ctype);
    for i = 1:nbClients
        supply = zeros (1, nbLocations + nbLocations*nbClients);
        supply((i*nbLocations+1):(i*nbLocations+nbLocations)) = ...
            ones (1, nbLocations);
        cplex.addRows(1, supply, 1);
    end
    for i = 1:nbLocations
        v = zeros (1, nbLocations + nbLocations*nbClients);
        v(i) = -capacity(i);
        v(i + nbLocations:nbLocations+i+nbClients*nbLocations) = ...
            ones(1, nbClients);
        cplex.addRows(-inf, v, 0);
    end
    cplex.solve();
    cplex.writeModel('fc.lp');
    % Display solution
    if cplex.Solution.status == 101
        fprintf ('\nMinimum Cost: %f \n', cplex.Solution.objval);
        open = cplex.Solution.x(1:nbLocations);
        supply = reshape (cplex.Solution.x(nbLocations+1:end), nbLocations,
nbClients);

        for i = 1:nbLocations
            if open(i) ~= 0

```

```

        fprintf ...
        ('Yard Block %d serves the following AGVs, yard trailers,
carriers:\n', i);
        for j = 1:nbClients
            if supply(i,j) >= cplex.Param.mip.tolerances.integrality.Cur
                fprintf ('%d ',j);
            end
        end
        fprintf ('\n');
    end
    end
    %Biograph begins.
    for k = 1:nbLocations
        str_comb=strcat('id:',num2str(k));
        bio_id(k) = {str_comb};
    end
    tree_CM = supply;
    bgInViewer = view(biograph(tree_CM,bio_id));
    %Biograph ends
    fprintf ('\nSolution status = %s\n', cplex.Solution.statusstring);
end
catch m
    disp (m.message);
end
end
end

```

Figure 5.57 The yard_area() funtion code at Matlab with utilization of CPLEX algorithm.

5.5 Vehicle Dispatching and Assignment Problem

In this section, an important aspect of vehicle dispatching and assignment problem at container terminals is considered. Many applications of the general assignment problem exist for container terminals. At fully automated container terminals, it is expected that all resources utilized efficiently and effectively without leaving behind redundant resources.

For instance, nowadays, at competitive container terminals, it is a common practice to update dynamically the exact location of container vehicles by GPS and wireless signals, such as for Straddle Carriers (SCs), ALVs, AGVs, and so on. For example, unmanned SCs operate freely at container terminal's yard area and pick up containers from/to yard blocks or from/to quay cranes. Specific job queues are assigned to container vehicles and the vehicles (manned or unmanned) follow procedure appearing on their screen on their computers' memory. Some container vehicles operate close to their given tasks. As such, some containers are near container vehicles (SCs, AGVs, etc.) and some are further away from them. Therefore, forcing operating container vehicles to complete the task or operating procedure whether or not the container is near or far from the vehicle cause higher

costs or consumption of enormous valuable time at the overall terminal operation. Solutions to such problems are known as terminal vehicle dispatching and assignment. The assignment problem, in such scenarios as mentioned above, considers minimizing the total costs (i.e. distance, time, etc.) while completing the task at an optimal possible level.

5.5.1 General Assignment Problem: Concepts

The generalized assignment problem (GAP) is finding a minimal cost (or maximal profit) assignment of n tasks over m capacity-constrained servers, whereby each task has to be processed by only one server (Sarker, 2008). The general assignment problem has wide range of applicable domains. For instance, one of these domains is the situation that arouses in container terminals (Cheung et al, 2002; Zhang et al, 2002). Given an n tasks over m capacity-constrained servers can be considered as assignment of n number of straddle carriers (SCs) or trailers to specific containers in order to minimize total time (t) consumed or cost (c) while handling the containers.

The general assignment problem can be described as,

Objective function

$$\text{Minimize } Z = \sum_{i=1}^n \sum_{j=1}^m C_{ij} x_{ij}$$

Subject to

$$\begin{aligned} \sum_{j=1}^m x_{ij} &= 1, & i &= 1, \dots, n \\ \sum_{i=1}^n a_{ij} x_{ij} &\leq b_j, & j &= 1, \dots, m \\ x_{ij} &\in \{0, 1\}, & i &= 1, \dots, n, \quad j = 1, \dots, m \end{aligned}$$

where parameters are

n = number of tasks

m = number of servers

C_{ij} = cost of assigning task i to server j

b_j = units of resource available to server j

a_{ij} = units of resource required to perform task i by server j

and variables

x_{ij} = 1 if task i is assigned to server j , 0 otherwise

Various algorithms exist for the solution of general assignment problem. For solving assignment problems in container terminal, two algorithms, namely the Hungarian and Jonker-Volgenant algorithms are considered. Both algorithms provide same solutions and the solutions are considered as the best possible optimal solutions for the given probability matrix.

The general assignment problem is also known as the maximum weighted bipartite matching problem. Given a bipartite graph $G(V,U,E)$ where V and U are two partitions and E edges between two partitions, the problem is the selection of a subset of the edges with maximum sum of weights such that each node $v \in V$ or $u \in U$ is connected to at most one edge.

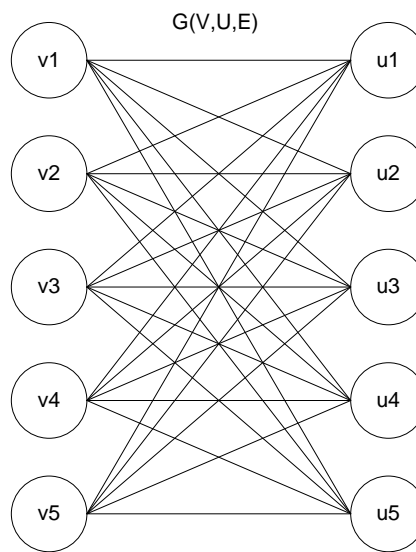

Figure 5.58 A sample Bipartite graph $G(V,U,E)$

5.5.2 Solutions to Assignment Problems

Solution to the assignment problem is given by the Hungarian or Kuhn-Munkres algorithm or, as an alternative algorithm by Jonker-Volgenant's algorithm.

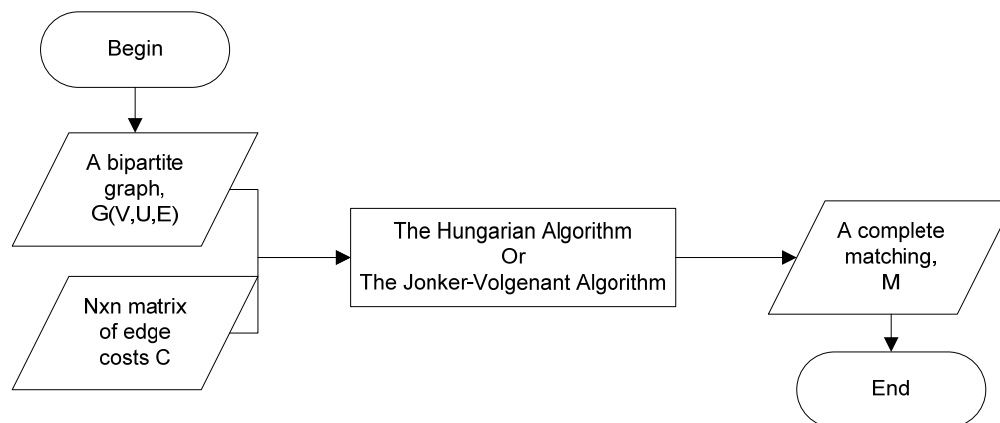

Figure 5.59 Flowchart for assignment algorithm

The solution pattern for the Hungarian algorithm is shown in fig. 5.60. The larger the assignment problem, the more time is required to return a solution. The time required for a solution exponentially increases.

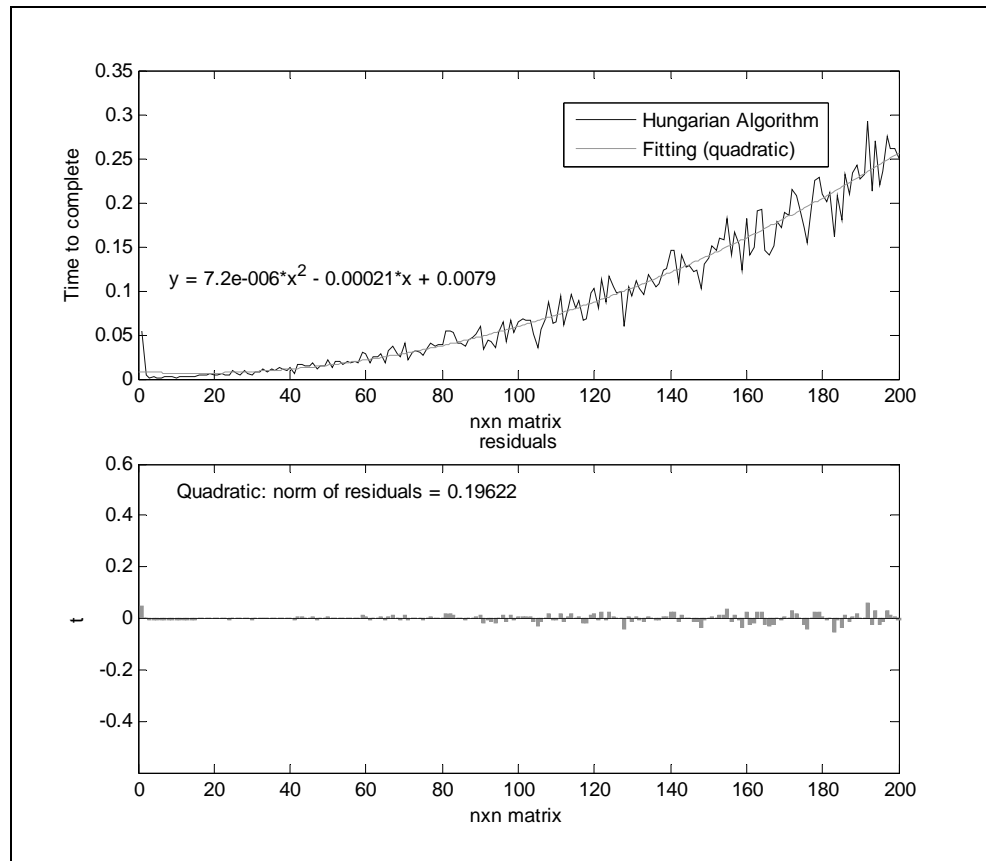

Figure 5.60 The Hungarian algorithm's *time to complete performance* based on nxn matrix with a quadratic fitting function and residuals

The Jonker-Volgenant algorithm also provides the same solutions for assignment problems. Just like the Hungarian algorithm, the time required for a solution also exponentially increases in JV algorithm. See fig. 5.60.

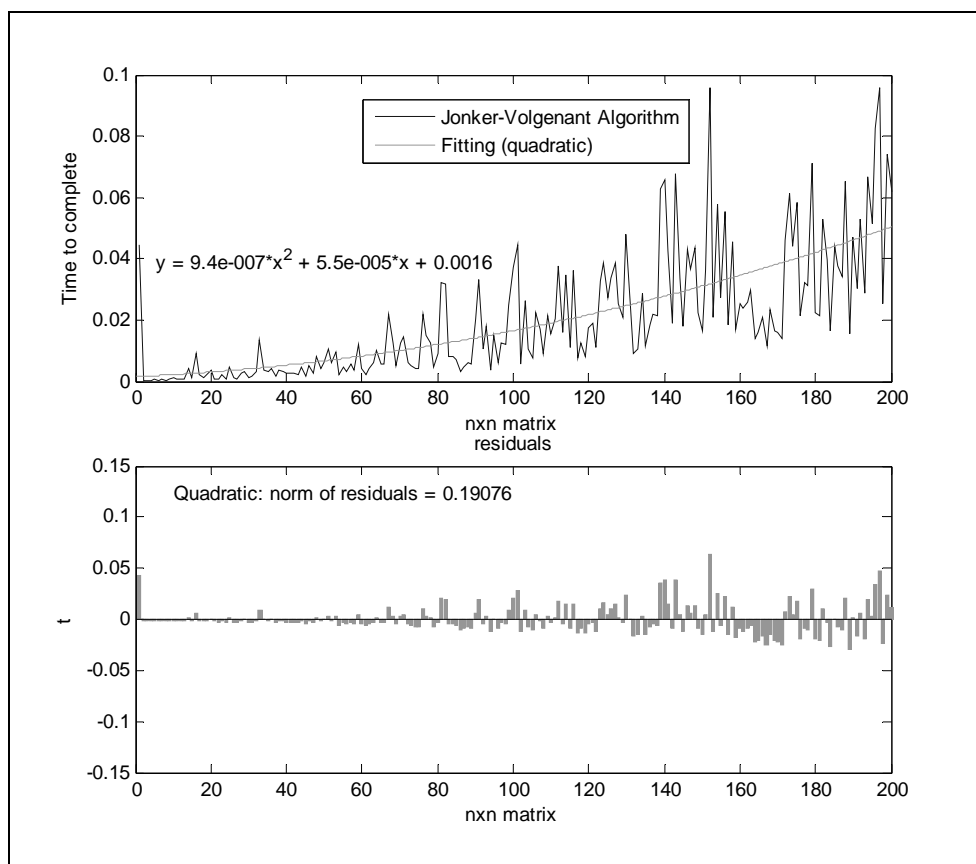

Figure 5.61 The Jonker-Volgenant algorithm's *time to complete performance* based on nxn matrix with a quadratic fitting function and residuals

In contrast, based on the benchmark tests of both the Hungarian and the JV algorithms, the JV algorithm has provided quicker solutions than the Hungarian algorithm. See fig 5.62.

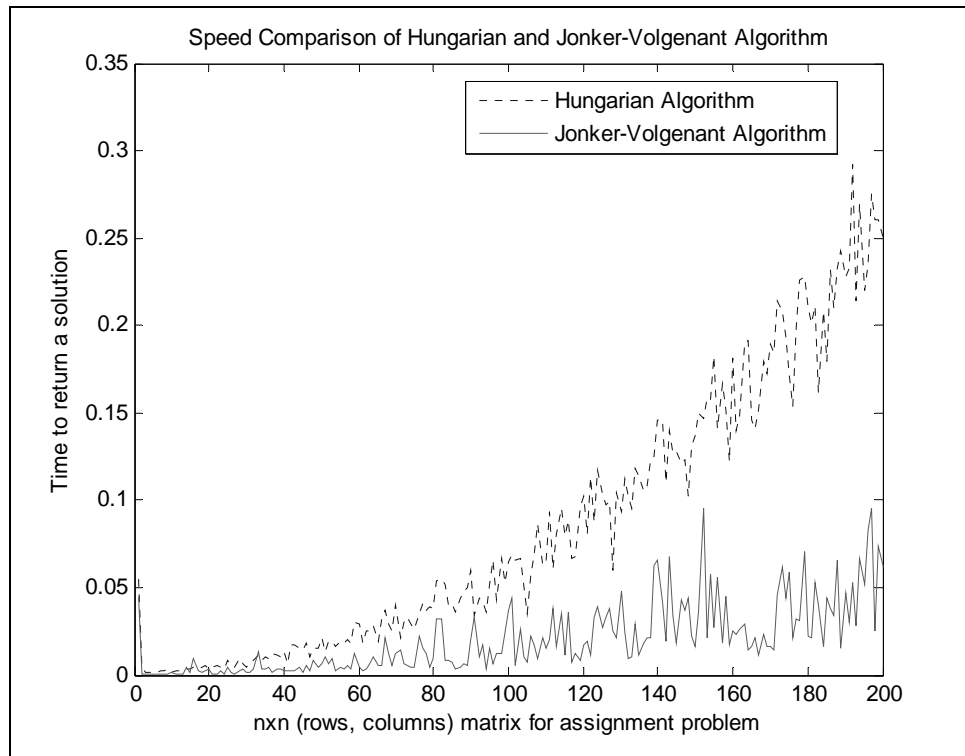

Figure 5.62 The performance comparison of Jonker-Volgenant algorithm versus Hungarian algorithm for the linear assignment problems

5.5.3 Assignment Problems at Container Terminals

Before generating solutions for the assignment problems, the initial step is the preparation of the cost matrix. Cost matrix can be in the form of a square matrix of $[n \times n]$. In today's fully automated container terminals, cost matrix which consists, for instance, distance costs of container vehicles can be calculated or computed by collecting exact locations (XY pairs) of vehicles through Global Positioning Systems (GPS) and radio waves at container terminals, and determining the associated costs of servers (i.e. quay cranes, location of containers, yard block's transfer points, etc.).

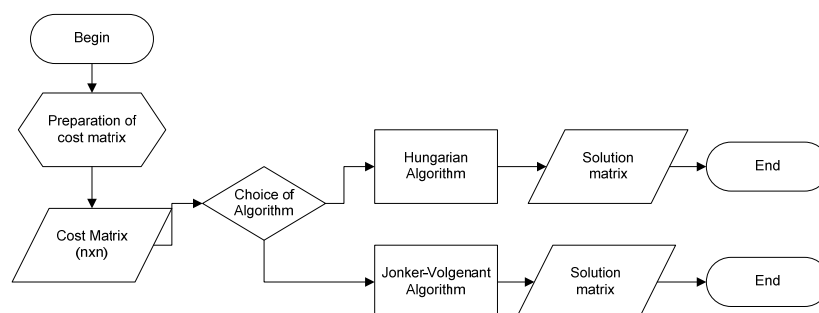

Figure 5.63 Flowchart of solving linear assignment problems by algorithms

Based on the retrieved exact locations of container vehicles of job(k), it becomes possible to create cost matrix of container vehicles versus servers (container locations at quay cranes, transfer points at yard blocks, etc.).

The matrix A shown below at table 5.11 is a sample square matrix having values of specific costs of matching n th client and m th servers.

Table 5.11 Cost Matrix A – 10X10

The figure 5.64 is the graphical visualization of cost matrix A. The interpretation of the figure is: the darker the cells the higher the costs, and the lighter the cells the lower the costs.

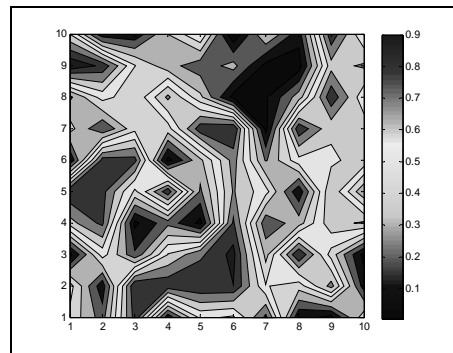

Figure 5.64 The cost matrix – 10 X 10

After running the algorithm, (the Hungarian or JV algorithm), the best possible assignment occurs as shown in figure 5.65. Not all other assignment configurations will be optimal based on the cost matrix of A and the solution matrix at table 5.12 and table 5.13. This instance is only an instant picture of 10 clients with 10 servers of a job (k). As container vehicles operate dynamically, a continuous supply of optimal assignment data to vehicles is crucial.

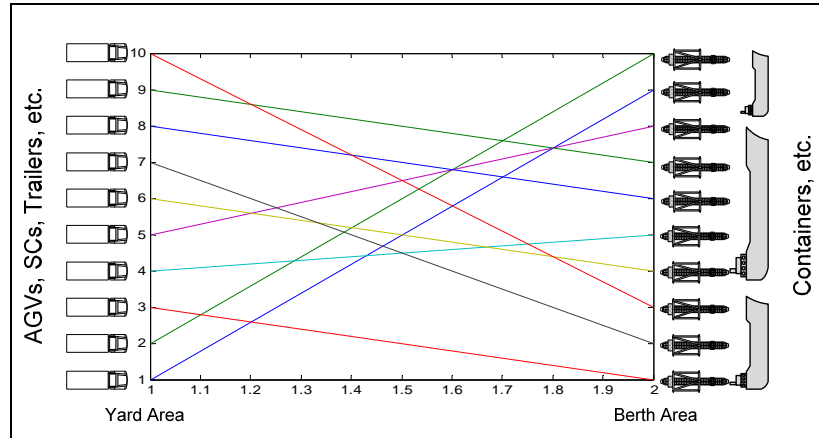

Figure 5.65 The best assignment solution for 10x10 matrix problem

Table 5.12 Solution matrix

$A =$	0.47	0.25	0.86	0.13	0.53	0.48	0.83	0.12	0.08	0.47
	0.54	0.13	0.90	0.87	0.89	0.90	0.51	0.44	0.74	0.14
	0.06	0.55	0.22	0.60	0.78	0.93	0.37	0.90	0.46	0.07
	0.66	0.83	0.08	0.27	0.07	0.82	0.23	0.35	0.67	0.71
	0.89	0.84	0.47	0.86	0.28	0.71	0.53	0.12	0.70	0.31
	0.11	0.83	0.84	0.06	0.38	0.74	0.29	0.57	0.57	0.67
	0.44	0.20	0.47	0.46	0.86	0.90	0.07	0.88	0.63	0.65
	0.28	0.54	0.41	0.72	0.42	0.07	0.08	0.35	0.88	0.53
	0.99	0.87	0.50	0.34	0.24	0.34	0.07	0.04	0.66	0.72
	0.61	0.12	0.13	0.40	0.60	0.00	0.41	0.14	0.88	0.50

Table 5.13 Best solution of assigning ids.

$S_{\min} =$	1	2	3	4	5	6	7	8	9	10
	9	10	1	5	8	4	2	6	7	3

In this chapter, two assignment algorithms are presented. JV algorithm performs better than the Hungarian algorithm. If a performance of an algorithm becomes an important case, JV algorithm can be preferred. The dynamic assignments can be provided at manned vehicles screens through wireless communication technology, or for unmanned vehicles, these data can be committed to their embedded computers' through wireless transfers. As a result, assignment operations at container terminals will be at possible optimum levels, which saves time and increase competitiveness.

```

function [rowsol,cost] = lapjv(costMat)
% LAPJV Jonker-Volgenant Algorithm for Linear
Assignment Problem.
% by Yi Cao at Cranfield University
% Prepare working data
dim = size(costMat,1);
free = zeros(dim,1);
matches = zeros(dim,1);
v = zeros(1,dim);
rowsol = zeros(1,dim)-1;
colsol = zeros(dim,1)-1;
numfree=0;

% The Initialization Phase
for j=dim:-1:1
    [v(j), imin] = min(costMat(:,j));
    if ~matches(imin)
        rowsol(imin)=j;
        colsol(j)=imin;
    else
        colsol(j)=-1;
    end
    matches(imin)=matches(imin)+1;
end

% Reduction transfer from unassigned to
assigned rows
for i=1:dim
    if ~matches(i)
        numfree=numfree+1;
        free(numfree)=i;
    else
        if matches(i) == 1
            j1 = rowsol(i);
            x = costMat(i,:)-v;
            x(j1) = Inf;
            v(j1) = v(j1) - min(x);
        end
    end
end

loopcnt = 0;
while loopcnt < 2
    loopcnt = loopcnt + 1;
    k = 0;
    prvnumfree = numfree;
    numfree = 0;
    while k < prvnumfree
        k = k+1;
        i = free(k);
        x = costMat(i,:) - v;
        [umin, j1] = min(x);
        x(j1) = Inf;
        [usubmin, j2] = min(x);
        i0 = colsol(j1);
        if usubmin - umin > eps
            v(j1) = v(j1) - (usubmin - umin);
        else % minimum and subminimum equal.
            if i0 > 0
                j1 = j2;
                i0 = colsol(j2);
            end
        end
        rowsol(i) = j1;
        colsol(j1) = i;
        if i0 > 0
            if usubmin - umin > eps
                free(k)=i0;
                k=k-1;
            else
                numfree = numfree + 1;
                free(numfree) = i0;
            end
        end
    end
end

for f=1:numfree
    freerow = free(f);
    d = costMat(freerow,:) - v;
    pred = freerow(1,ones(1,dim));
    collist = 1:dim;
    low = 1;
    up = 1;
    unassignedfound = false;
    while ~unassignedfound
        if up == low
            last = low-1;
            minh = d(collist(up));
            up = up + 1;
            for k=up:dim
                j = collist(k);
                h = d(j);
                if h<=minh
                    if h<minh
                        up = low;
                        minh = h;
                    end
                    collist(k) = collist(up);
                    collist(up) = j;
                    up = up + 1;
                end
            end
            for k=low:up-1
                if colsol(collist(k)) < 0
                    endofpath = collist(k);
                    unassignedfound = true;
                    break
                end
            end
        end
        if ~unassignedfound
            j1 = collist(low);
            low=low+1;
            i = colsol(j1); %line 215
            x = costMat(i,:)-v;
            h = x(j1) - minh;
            xh = x-h;
            k=up:dim;
            j=collist(k);
            vf0 = xh<d;
            vf = vf0(j);
            vj = j(vf);
            vk = k(vf);
            pred(vj)=i;
            v2 = xh(vj);
            d(vj)=v2;
            vf = v2 == minh;
            j2 = vj(vf);
            k2 = vk(vf);
            cf = colsol(j2)<0;
            if any(cf)
                i2 = find(cf,1);
                endofpath = j2(i2);
                unassignedfound = true;
            else
                i2 = numel(cf)+1;
            end
            for k=1:i2-1
                collist(k2(k)) = collist(up);
                collist(up) = j2(k);
                up = up + 1;
            end
        end
    end
    % update column prices
    j1=collist(1:last+1);
    v(j1) = v(j1) + d(j1) - minh;
    while 1
        i=pred(endofpath);
        colsol(endofpath)=i;
        j1=endofpath;
        endofpath=rowsol(i);
        rowsol(i)=j1;
        if (i==freerow)
            break
        end
    end
end
cost = sum(diag(costMat(:,rowsol)));

```

Figure 5.66 Jonker-Volgenant Algorithm

```

function [assignment,cost] =
munkres(costMat)
% MUNKRES Munkres (Hungarian) Algorithm
for Linear Assignment Problem.
%
% [ASSIGN,COST] = munkres(COSTMAT) returns
the optimal column indices,
% ASSIGN assigned to each row and the
minimum COST based on the assignment
% problem represented by the COSTMAT, where
the (i,j)th element represents the cost to
assign the jth
% job to the ith worker.
%
% version 2.2 by Yi Cao at Cranfield
University on 1st March 2010

assignment = zeros(1,size(costMat,1));
cost = 0;

costMat(costMat~=costMat)=Inf;
validMat = costMat<Inf;
validCol = any(validMat,1);
validRow = any(validMat,2);

nRows = sum(validRow);
nCols = sum(validCol);
n = max(nRows,nCols);
if ~n
    return
end

maxv=10*max(costMat(validMat));

dMat = zeros(n) + maxv;
dMat(1:nRows,1:nCols) =
costMat(validRow,validCol);

minR = min(dMat,[],2);
minC = min(bsxfun(@minus, dMat, minR));

zP = dMat == bsxfun(@plus, minC, minR);

starZ = zeros(n,1);
while any(zP(:))
    [r,c]=find(zP,1);
    starZ(r)=c;
    zP(r,:)=false;
    zP(:,c)=false;
end

while 1
    if all(starZ>0)
        break
    end
    coverColumn = false(1,n);
    coverColumn(starZ(starZ>0))=true;
    coverRow = false(n,1);
    primeZ = zeros(n,1);
    [rIdx, cIdx] =
find(dMat(~coverRow,~coverColumn)==bsxfun(@
plus,minR(~coverRow),minC(~coverColumn)));
    while 1
        cR = find(~coverRow);
        cC = find(~coverColumn);
        rIdx = cR(rIdx);
        cIdx = cC(cIdx);
        Step = 6;
        while ~isempty(cIdx)
            uZr = rIdx(1);
            uZc = cIdx(1);
            primeZ(uZr) = uZc;
            stz = starZ(uZr);
            if ~stz
                Step = 5;
                break;
            end
            coverRow(uZr) = true;
            coverColumn(stz) = false;
            z = rIdx==uZr;
            rIdx(z) = [];
            cIdx(z) = [];
            cR = find(~coverRow);
            z = dMat(~coverRow,stz) ==
minR(~coverRow) + minC(stz);
            rIdx = [rIdx(:);cR(z)];
            cIdx =
[cIdx(:);stz(ones(sum(z),1))];
            end
            if Step == 6

[minval,rIdx,cIdx]=outerplus(dMat(~coverRow
,~coverColumn),minR(~coverRow),minC(~coverC
olumn));
                minC(~coverColumn) =
minC(~coverColumn) + minval;
                minR(coverRow) = minR(coverRow)
- minval;
                else
                    break
                end
            end
            rowZ1 = find(starZ==uZc);
            starZ(uZr)=uZc;
            while rowZ1>0
                starZ(rowZ1)=0;
                uZc = primeZ(rowZ1);
                uZr = rowZ1;
                rowZ1 = find(starZ==uZc);
                starZ(uZr)=uZc;
            end
        end
    end

% Cost of assignment
rowIdx = find(validRow);
colIdx = find(validCol);
starZ = starZ(1:nRows);
vIdx = starZ <= nCols;
assignment(rowIdx(vIdx)) =
colIdx(starZ(vIdx));
cost =
trace(costMat(assignment>0,assignment(assig
nment>0)));

function
[minval,rIdx,cIdx]=outerplus(M,x,y)
ny=size(M,2);
minval=inf;
for c=1:ny
    M(:,c)=M(:,c)-(x+y(c));
    minval = min(minval,min(M(:,c)));
end
[rIdx,cIdx]=find(M==minval);

```

Figure 5.67 The Hungarian Algorithm

5.6 Testing the Hypothesis: Decision Making of Human versus Computers

H0 (Null hypothesis): Human decision-making process can satisfy solutions for small-scale [25X25] combinatorial optimization problems.

Test 1:

One Way Analysis of Variance

Normality Test: Failed (P < 0.050)

Test execution ended by user request, ANOVA on Ranks begun

Kruskal-Wallis One Way Analysis of Variance on Ranks

Group N	Missing	Median	25%	75%
Human 10	5	0	32.353	32.353
Computer 10	5	0	32.353	32.353

H = 0.000 with 1 degrees of freedom. P(est.)= 1.000 P(exact)= 1.000

The differences in the median values among the treatment groups [10X10] are not great enough to exclude the possibility that the difference is due to random sampling variability; there is not a statistically significant difference (P = 1.000)

Test 2:

One Way Analysis of Variance

Normality Test: Failed (P < 0.050)

Test execution ended by user request, ANOVA on Ranks begun

Kruskal-Wallis One Way Analysis of Variance on Ranks

Group N	Missing	Median	25%	75%
Human 15	5	0	27.134	26.969
Computer 15	5	0	27.082	26.587

H = 2.992 with 1 degrees of freedom. P(est.)= 0.084 P(exact)= 0.095

The differences in the median values among the treatment groups [15X15] are not great enough to exclude the possibility that the difference is due to random sampling variability; there is not a statistically significant difference (P = 0.095)

Test 3:

One Way Analysis of Variance

Normality Test: Passed (P = 0.811)

Equal Variance Test: Passed (P = 0.992)

Group Name	N	Missing	Mean	Std Dev	SEM
Human 20	5	0	46.680	1.221	0.546
Computer 20	5	0	45.204	1.192	0.533

Source of Variation	DF	SS	MS	F	P
Between Groups	1	5.445	5.445	3.740	0.089
Residual	8	11.648	1.456		
Total	9	17.093			

The differences in the mean values among the treatment groups [20X20] are not great enough to exclude the possibility that the difference is due to random sampling variability; there is not a statistically significant difference ($P = 0.089$). Power of performed test with $\alpha = 0.050$: 0.299 The power of the performed test (0.299) is below the desired power of 0.800. Less than desired power indicates it is less likely to detect a difference when one actually exists. Negative results should be interpreted cautiously.

Pearson Product Moment Correlation

Cell Contents:

Correlation Coefficient

P Value

Number of Samples

Computer 25

Human 25	0.100	Correlation Coefficient
	0.872	P Value
	5	Number of Samples

There are no significant relationships between any pair of variables in the correlation table ($P > 0.050$).

Test 4:

One Way Analysis of Variance

Normality Test: Passed ($P = 0.873$)

Equal Variance Test: Passed ($P = 0.684$)

Group Name	N	Missing	Mean	Std Dev	SEM
Human 25	5	0	43.604	1.672	0.748
Computer 25	5	0	38.197	2.110	0.944

Source of Variation	DF	SS	MS	F	P
Between Groups	1	73.083	73.083	20.168	0.002
Residual	8	28.990	3.624		
Total	9	102.074			

Power of performed test with $\alpha = 0.050$: 0.975

All Pairwise Multiple Comparison Procedures (Holm-Sidak method):

Overall significance level = 0.05

Comparisons for factor:

Comparison	Diff of Means	t	Unadjusted P	Critical Level	Significant?
[25X25]	5.407	4.491	0.002	0.050	Yes

Table 5.14 Computer vs Human decision making – Experimental data

Human 10	Computer 10	Human 15	Computer 15	Human 20	Computer 20	Human 25	Computer 25
32.3533	32.3533	26.63199	27.08161	47.50215	45.77398	44.65005	35.31254
32.3533	32.3533	27.13411	26.58685	44.87212	44.43126	42.26466	37.16675
32.3533	32.3533	27.08161	26.58685	47.22931	46.88535	41.46371	39.16439
32.3533	32.3533	27.88643	27.08161	47.79963	43.81715	45.43275	40.92525
32.3533	32.3533	32.60082	27.08161	45.99624	45.11264	44.21013	38.41845

The differences in the mean values among the treatment groups [25X25] are greater than would be expected by chance; *there is a statistically significant difference* ($P = 0.002$). Thus, it is safe to reject the null hypothesis and accept the alternative hypothesis for the problems having the complexity of more than [25X25]. Table 5.14 is the experimental data used to test the hypothesis.

This chapter presented comprehensive solutions to the key operational problems. Cutting-edge methodologies and algorithms are used in this chapter to solve the operational problems. Numerous complex combinatorial optimization problems and assignment problems can be solved by utilizing the methods, algorithms, and/or techniques presented in this chapter.

Experimental results show that the methods introduced in this chapter is applicable to the solution of various operational problems. For more visual information about other terminal equipments and for further details of CE method, refer to the appendices section. Next chapter introduces various important hypotheses and the results of these hypotheses.

CHAPTER SIX

LOGISTICAL PERFORMANCE INDICATORS: DEVELOPMENT OF HYPOTHESES, ANALYSIS, AND TESTINGS

In this chapter, several hypotheses are developed, analyzed and tested. Hypotheses testing are done by using the “t-test”. Hypothesized population mean is tested across several income groups¹. These income group countries are namely lower middle income countries, upper middle income countries, high income countries that are member of OECD and high income countries that are not member of OECD. Hypotheses results give important clues about the current state of Turkey’s logistics performance index and thereby an idea and a reflection of seaport terminals. The raw data are retrieved from the World Bank WDI database. Further information about the data used to test hypotheses can be found at Appendix section.

6.1 Hypotheses

As one important part of logistics services, seaport terminals play crucial role in logistics service performance (Dowd and Leschine, 1990). Additionally, containerized intermodal transportation supports a significant part of the international movement of goods (Crainic and Kim, 2007). Thus, logistics performance data are one of the most likely representatives of seaports' service performance indicators. Based on the most recent data (Year 2009) provided by World Bank World Development Indicators (WDI) database, a thorough investigation is made by developing, applying statistical methods, and testing hypotheses. It is stated by

¹

High income OECD countries: Australia, Austria, Belgium, Canada, Czech, Republic, Denmark, Finland, France, Germany, Greece, Hungary, Iceland, Ireland, Italy, Japan, Korea, Rep., Luxembourg, Netherlands, New Zealand, Norway, Portugal, Slovak Republic, Spain, Sweden, Switzerland, United, Kingdom, United States

High income non-OECD countries: Andorra, Antigua, and, Barbuda, Aruba, Bahamas, The, Bahrain, Barbados, Bermuda, Brunei, Darussalam, Cayman, Islands, Channel, Islands, Croatia, Cyprus, Equatorial, Guinea, Estonia, Faeroe, Islands, French, Polynesia, Greenland, Guam, Hong, Kong, SAR, China, Isle, of, Man, Israel, Kuwait, Liechtenstein, Macao, SAR, China, Malta, Monaco, Netherlands, Antilles, New, Caledonia, Northern, Mariana, Islands, Oman, Puerto, Rico, Qatar, San, Marino, Saudi, Arabia, Singapore, Slovenia, Trinidad, and, Tobago, United, Arab, Emirates, Virgin, Islands, (U.S.)

Upper middle income countries: Algeria, American, Samoa, Argentina, Belarus, Bosnia, and, Herzegovina, Botswana, Brazil, Bulgaria, Chile, Colombia, Costa, Rica, Cuba, Dominica, Dominican, Republic, Fiji, Gabon, Grenada, Jamaica, Kazakhstan, Latvia, Lebanon, Libya, Lithuania, Macedonia, FYR, Malaysia, Mauritius, Mayotte, Mexico, Montenegro, Namibia, Palau, Panama, Peru, Poland, Romania, Russian, Federation, Serbia, Seychelles, South, Africa, St., Kitts, and, Nevis, St., Lucia, St., Vincent, and, the, Grenadines, Suriname, Turkey, Uruguay, Venezuela, RB

Lower middle income countries: Albania, Angola, Armenia, Azerbaijan, Belize, Bhutan, Bolivia, Cameroon, Cape, Verde, China, Congo, Rep., Cote, d'Ivoire, Djibouti, Ecuador, Egypt, Arab, Rep., El, Salvador, Georgia, Guatemala, Guyana, Honduras, India, Indonesia, Iran, Islamic, Rep., Iraq, Jordan, Kiribati, Kosovo, Lesotho, Maldives, Marshall, Islands, Micronesia, Fed., Sts., Moldova, Mongolia, Morocco, Nicaragua, Nigeria, Pakistan, Papua, New, Guinea, Paraguay, Philippines, Samoa, Sao, Tome, and, Principe, Solomon, Islands, Sri, Lanka, Sudan, Swaziland, Syrian, Arab, Republic, Thailand, Timor-Leste, Tonga, Tunisia, Turkmenistan, Ukraine, Vanuatu, West Bank and Gaza

World Bank that World Development Indicators (WDI) is the primary World Bank database for development data from officially recognized international sources.

Seven main hypotheses are developed and listed as,

- the ability to track and trace consignments of logistics services,
- the competence and quality of logistics services,
- the ease of arranging competitively priced shipments of logistics services,
- the efficiency of customs clearance process of logistics services,
- the frequency with which shipments reach consignee within scheduled or expected time,
- the quality of trade and transport-related infrastructure,
- and the overall logistics services performance

Based on the key hypotheses, region and income group level sub-hypotheses are also developed. The list of these hypotheses is:

- **H1a:** The ability to track and trace consignments of logistics services in Turkey differs in a positive and a significant manner in comparison to lower middle-income countries.
- **H1b:** The ability to track and trace consignments of logistics services in Turkey has no significant difference in comparison to upper middle-income group.
- **H1c:** The ability to track and trace consignments of logistics services in Turkey differs in a negative and a significant manner in comparison to high-income OECD countries.
- **H1d:** The ability to track and trace consignments of logistics services in Turkey differs in a negative and a significant manner in comparison to high-income non-OECD countries.
- **H2a:** The competence and quality of logistics services in Turkey differs in a positive and a significant manner in comparison to lower middle-income countries.

- **H2b:** The competence and quality of logistics services in Turkey has no significant difference in comparison to upper middle-income group.
- **H2c:** The competence and quality of logistics services in Turkey differs in a negative and a significant manner in comparison to high-income OECD countries.
- **H2d:** The competence and quality of logistics services in Turkey differs in a negative and a significant manner in comparison to high-income non-OECD countries.
- **H3a:** The ease of arranging competitively priced shipments of logistics services in Turkey differs in a positive and a significant manner in comparison to lower middle-income countries.
- **H3b:** The ease of arranging competitively priced shipments of logistics services in Turkey has no significant difference in comparison to upper middle-income group.
- **H3c:** The ease of arranging competitively priced shipments of logistics services in Turkey differs in a negative and a significant manner in comparison to high-income OECD countries.
- **H3d:** The ease of arranging competitively priced shipments of logistics services in Turkey differs in a negative and a significant manner in comparison to high-income non-OECD countries.
- **H4a:** The efficiency of customs clearance process of logistics services in Turkey differs in a positive and a significant manner in comparison to lower middle-income countries.
- **H4b:** The efficiency of customs clearance process of logistics services in Turkey has no significant difference in comparison to upper middle-income group.
- **H4c:** The efficiency of customs clearance process of logistics services in Turkey differs in a negative and a significant manner in comparison to high-income OECD countries.
- **H4d:** The efficiency of customs clearance process of logistics services in Turkey differs in a negative and a significant manner in comparison to high-income non-OECD countries.

- **H5a:** The frequency with which shipments reach consignee within scheduled or expected time in Turkey differs in a positive and a significant manner in comparison to lower middle-income countries.
- **H5b:** The frequency with which shipments reach consignee within scheduled or expected time in Turkey has no significant difference in comparison to upper middle-income group.
- **H5c:** The frequency with which shipments reach consignee within scheduled or expected time in Turkey differs in a negative and a significant manner in comparison to high-income OECD countries.
- **H5d:** The frequency with which shipments reach consignee within scheduled or expected time in Turkey differs in a negative and a significant manner in comparison to high-income non-OECD countries.
- **H6a:** The quality of trade and transport-related infrastructure in Turkey differs in a positive and a significant manner in comparison to lower middle-income countries.
- **H6b:** The quality of trade and transport-related infrastructure in Turkey has no significant difference in comparison to upper middle-income group.
- **H6c:** The quality of trade and transport-related infrastructure in Turkey differs in a negative and a significant manner in comparison to high-income OECD countries.
- **H6d:** The quality of trade and transport-related infrastructure in Turkey differs in a negative and a significant manner in comparison to high-income non-OECD countries.
- **H7a:** The overall logistics services performance index of Turkey differs in a positive and a significant manner in comparison to lower middle-income countries.
- **H7b:** The overall logistics services performance index of Turkey is not significantly different in comparison to upper middle-income group.
- **H7c:** The overall logistics services performance index of Turkey differs in a negative and a significant manner in comparison to high-income OECD countries.

- **H7d:** The overall logistics services performance index of Turkey differs in a negative and a significant manner in comparison to high-income non-OECD countries.

6.2 Analysis and Testing of the Hypotheses

In this section, stated hypothesis is followed by its descriptive statistics table and the one sample t-test table. For each hypothesis test, refer to the respective table data for more details about the data.

H1a: The ability to track and trace consignments of logistics services in Turkey differs in a positive and a significant manner in comparison to lower middle-income countries.

Table 6.1 Descriptive statistics of hypothesis H1a.

Size	Missing	Mean	Std.Dev.	Std.Error	C.I. of Mean
40	0	2.588	0.347	0.0548	0.111
Range	Max.	Min.	Median	25%	75%
1.590	3.550	1.960	2.540	2.385	2.715
Skewness	Kurtosis	K-S Dist.	K-S Prob.	SWilk W.	SWilk Prob.
0.858	1.138	0.126	0.106	0.941	0.037

Table 6.2 One sample t-test of hypothesis H1a.

Normality Test:		Failed	(P < 0.050)		
N	Missing	Mean	Std.Dev.	SEM	
40	0	2.588	0.347	0.0548	

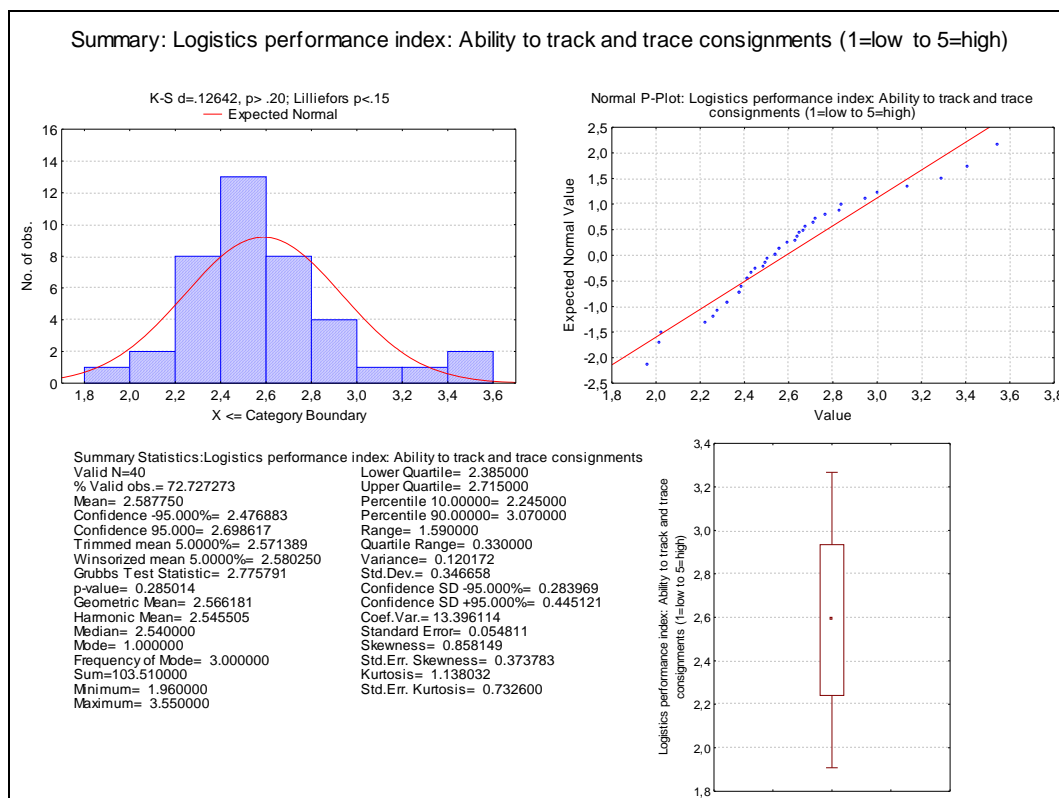

Figure 6.1 Descriptive statistics of the data

Hypothesized population mean is 3.090 and $t = -9.163$ with 39 degrees of freedom ($P = <0.001$). 95 percent confidence interval for the population mean: 2.477 to 2.699 and the power of performed test with $\alpha = 0.050$: 1.000 (See the figure and tables above).

There is a statistically significant difference between the mean of the sampled population and the hypothesized population mean ($P = <0.001$). Therefore, the null hypothesis is true and it is safe to accept the hypothesis H1a. H1a is supported.

H1b: The ability to track and trace consignments of logistics services in Turkey has no significant difference in comparison to upper middle-income group.

Table 6.3 Descriptive statistics of hypothesis H1b.

Size	Missing	Mean	Std.Dev.	Std.Error	C.I. of Mean
34	0	2.868	0.458	0.0785	0.160
Range	Max.	Min.	Median	25%	75%
1.770	3.730	1.960	2.865	2.600	3.260
Skewness	Kurtosis	K-S Dist.	K-S Prob.	SWilk W.	SWilk Prob.
-0.331	-0.488	0.0986	0.511	0.967	0.373

Table 6.4 One sample t-test of hypothesis H1b.

Normality Test: Passed (P = 0.373)				
N	Missing	Mean	Std.Dev.	SEM
34	0	2.868	0.458	0.0785

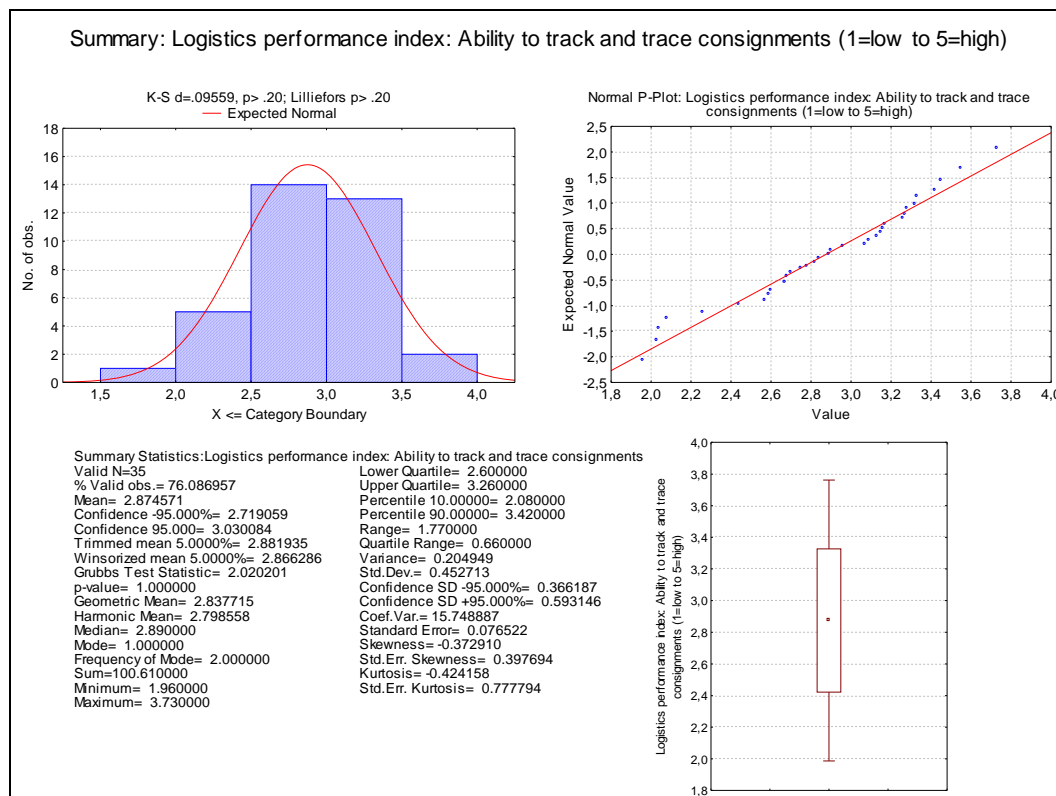

Figure 6.2 Descriptive statistics of the data

Hypothesized population mean is 3.090 and $t = -2.824$ with 33 degrees of freedom ($P = 0.008$). 95 percent confidence interval for the population mean: 2.708 to 3.028 and the power of performed test with $\alpha = 0.050$: 0.783 (See the figure and tables above).

There is a statistically significant difference between the mean of the sampled population and the hypothesized population mean ($P = 0.008$). The null hypothesis is not true and it is safe to reject the null hypothesis and accept the alternative hypothesis. H1b is rejected.

H1c: The ability to track and trace consignments of logistics services in Turkey differs in a negative and a significant manner in comparison to high-income OECD countries.

Table 6.5 Descriptive statistics of hypothesis H1c.

Size	Missing	Mean	Std.Dev.	Std.Error	C.I. of Mean
27	0	3.865	0.355	0.0684	0.141
Range	Max.	Min.	Median	25%	75%
1.400	4.270	2.870	3.960	3.710	4.127
Skewness	Kurtosis	K-S Dist.	K-S Prob.	SWilk W.	SWilk Prob.
-1.306	1.260	0.201	0.006	0.872	0.003

Table 6.6 One sample t-test of hypothesis H1c.

Normality Test:		Failed (P < 0.050)			
N	Missing	Mean	Std.Dev.	SEM	
27	0	3.865	0.355	0.0684	

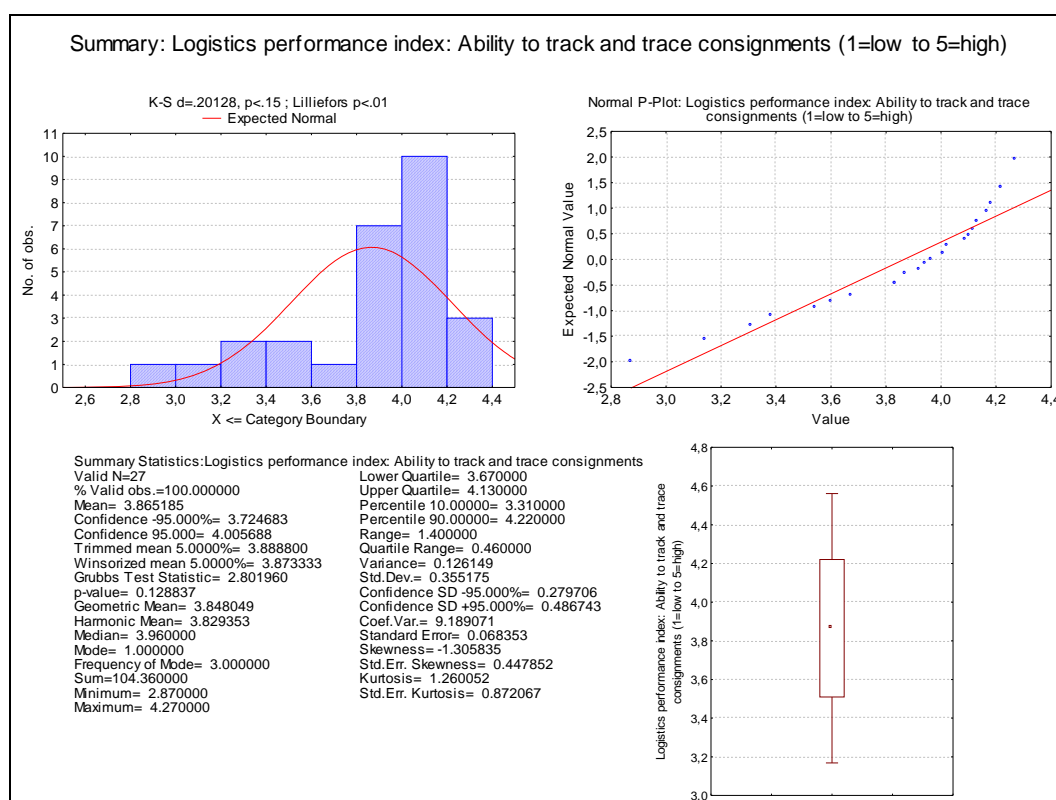

Figure 6.3 Descriptive statistics of the data

Hypothesized population mean is 3.090 and $t = 11.341$ with 26 degrees of freedom ($P = <0.001$). 95 percent confidence interval for the population mean: 3.725 to 4.006 and the power of performed test with $\alpha = 0.050$: 1.000 (See the figure and tables above).

There is a statistically significant difference between the mean of the sampled population and the hypothesized population mean ($P = <0.001$). Therefore, it is safe to accept the null hypothesis and reject the alternative hypothesis. H1c is supported.

H1d: The ability to track and trace consignments of logistics services in Turkey differs in a negative and a significant manner in comparison to high-income non-OECD countries.

Table 6.7 Descriptive statistics of hypothesis H1d.

Size	Missing	Mean	Std.Dev.	Std.Error	C.I. of Mean
15	0	3.226	0.541	0.140	0.300
Range	Max.	Min.	Median	25%	75%
2.110	4.150	2.040	3.320	2.853	3.563
Skewness	Kurtosis	K-S Dist.	K-S Prob.	SWilk W.	SWilk Prob.
-0.429	0.429	0.102	0.820	0.982	0.982

Table 6.8 One sample t-test of hypothesis H1d.

Normality Test:		Passed	(P = 0.982)	
N	Missing	Mean	Std.Dev.	SEM
15	0	3.226	0.541	0.140

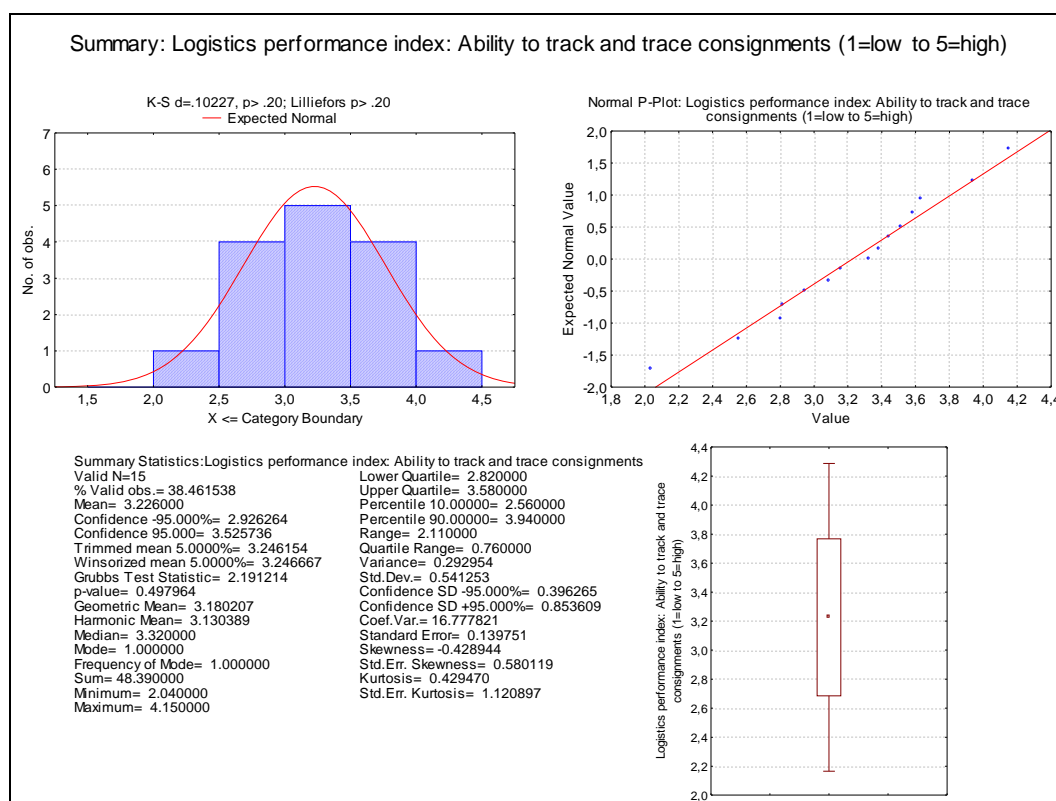

Figure 6.4 Descriptive statistics of the data

Hypothesized population mean is 3.090 and $t = 0.973$ with 14 degrees of freedom ($P = 0.347$). 95 percent confidence interval for the population mean: 2.926 to 3.526 and the power of performed test with $\alpha = 0.050$: 0.148 (See the figure and tables above).

The power of the performed test (0.148) is below the desired power of 0.800. Less than desired power indicates it is less likely to detect a difference when one actually exists. Negative results should be interpreted cautiously.

The difference between the mean of the sampled population and the hypothesized population mean is not great enough to reject the hypothesis that the difference is only due to random sample variability. There is not a significant difference between the two means ($P = 0.347$). Therefore, it is safe to reject the null hypothesis. Based on the test, the ability to track and trace consignments of logistics services in Turkey differs in a positive and a non-significant manner in comparison to high-income non-OECD countries. H1d is rejected.

H2a: The competence and quality of logistics services in Turkey differs in a positive and a significant manner in comparison to lower middle-income countries.

Table 6.9 Descriptive statistics of hypothesis H2a.

Size	Missing	Mean	Std.Dev.	Std.Error	C.I. of Mean
40	0	2.486	0.312	0.0493	0.0998
Range	Max.	Min.	Median	25%	75%
1.470	3.490	2.020	2.460	2.260	2.590
Skewness	Kurtosis	K-S Dist.	K-S Prob.	SWilk W.	SWilk Prob.
1.233	1.977	0.157	0.014	0.910	0.004

Table 6.10 One sample t-test of hypothesis H2a.

Normality Test:		Failed	(P < 0.050)		
N	Missing	Mean	Std.Dev.	SEM	
40	0	2.486	0.312	0.0493	

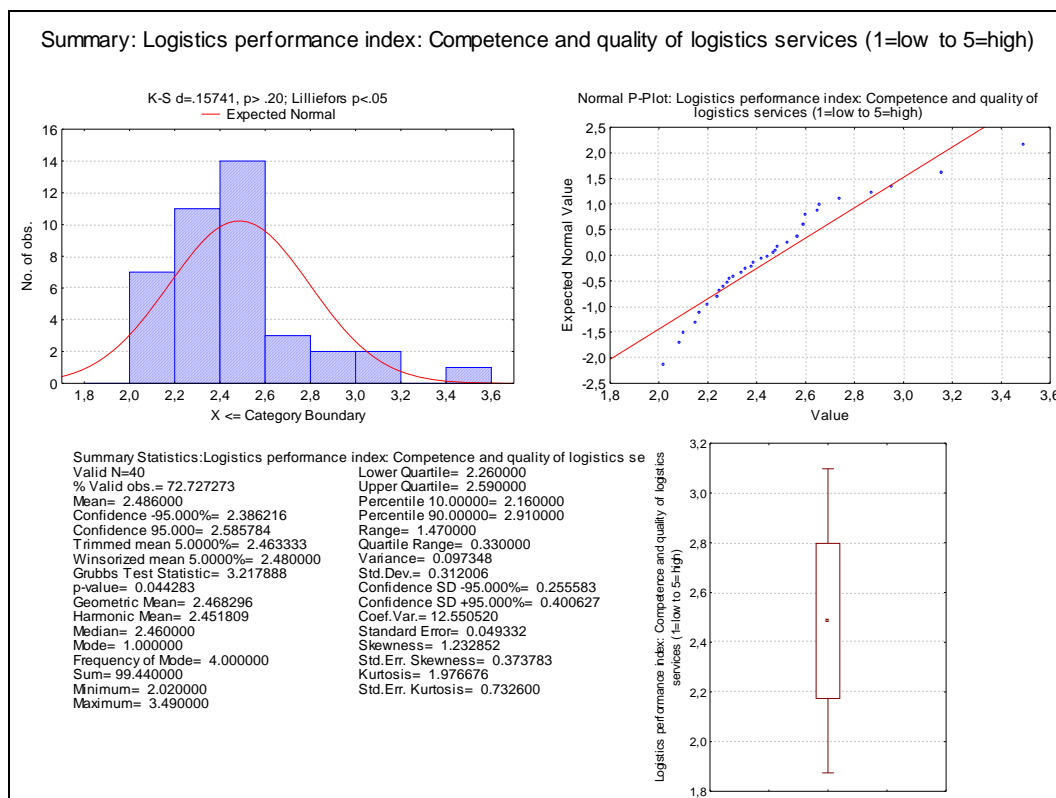

Figure 6.5 Descriptive statistics of the data

Hypothesized population mean is 3.230 and $t = -15.081$ with 39 degrees of freedom ($P = <0.001$). 95 percent confidence interval for the population mean: 2.386 to 2.586 and the power of performed test with $\alpha = 0.050$: 1.000 (See the figure and tables above).

There is a statistically significant difference between the mean of the sampled population and the hypothesized population mean ($P = <0.001$). Therefore, it is safe to accept the null hypothesis. H2a is supported.

H2b: The competence and quality of logistics services in Turkey has no significant difference in comparison to upper middle-income group.

Table 6.11 Descriptive statistics of hypothesis H2b.

Size	Missing	Mean	Std.Dev.	Std.Error	C.I. of Mean
34	0	2.678	0.434	0.0745	0.152
Range	Max.	Min.	Median	25%	75%
1.850	3.730	1.880	2.605	2.320	2.940
Skewness	Kurtosis	K-S Dist.	K-S Prob.	SWilk W.	SWilk Prob.
0.553	0.0348	0.0913	0.615	0.971	0.476

Table 6.12 One sample t-test of hypothesis H2b.

Normality Test:		Passed	(P = 0.476)		
N	Missing	Mean	Std.Dev.	SEM	
34	0	2.678	0.434	0.0745	

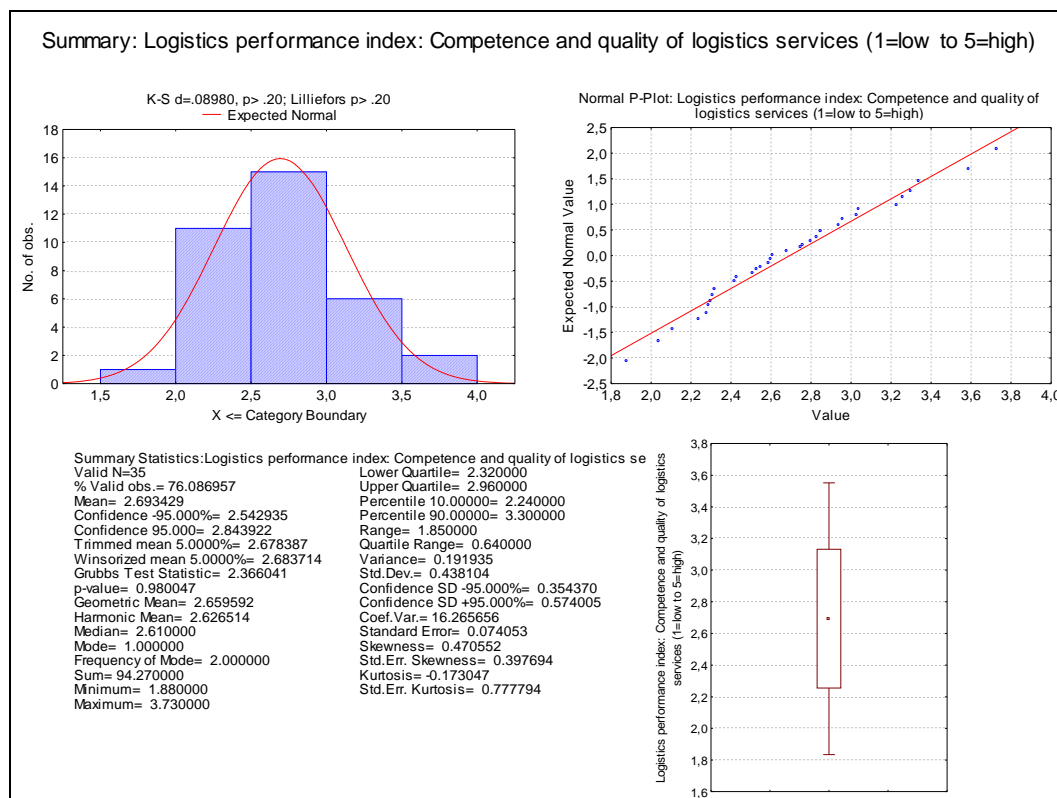

Figure 6.6 Descriptive statistics of the data

Hypothesized population mean is 3.230 and $t = -7.413$ with 33 degrees of freedom ($P = <0.001$). 95 percent confidence interval for the population mean: 2.526 to 2.829 and the power of performed test with $\alpha = 0.050$: 1.000 (See the figure and tables above).

There is a statistically significant difference between the mean of the sampled population and the hypothesized population mean ($P = <0.001$). Therefore, it is safe to reject the null hypothesis. H2b is rejected.

H2c: The competence and quality of logistics services in Turkey differs in a negative and a significant manner in comparison to high-income OECD countries.

Table 6.13 Descriptive statistics of hypothesis H2c.

Size	Missing	Mean	Std.Dev.	Std.Error	C.I. of Mean
27	0	3.711	0.409	0.0786	0.162
Range	Max.	Min.	Median	25%	75%
1.630	4.320	2.690	3.820	3.560	3.973
Skewness	Kurtosis	K-S Dist.	K-S Prob.	SWilk W.	SWilk Prob.
-0.912	0.415	0.153	0.104	0.930	0.069

Table 6.14 One sample t-test of hypothesis H2c.

Normality Test:		Passed (P = 0.069)			
N	Missing	Mean	Std.Dev.	SEM	
27	0	3.711	0.409	0.0786	

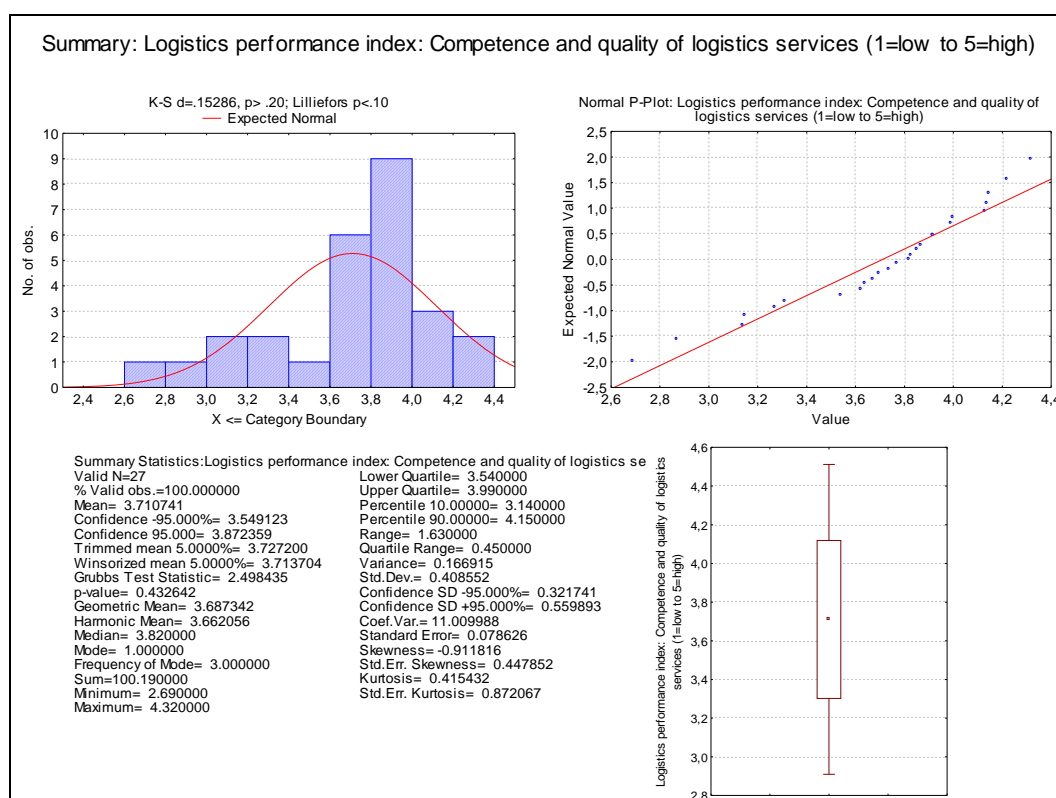

Figure 6.7 Descriptive statistics of the data

Hypothesized population mean is 3.230 and $t = 6.114$ with 26 degrees of freedom ($P = <0.001$). 95 percent confidence interval for the population mean: 3.549 to 3.872 and the power of performed test with $\alpha = 0.050$: 1.000 (See the figure and tables above).

There is a statistically significant difference between the mean of the sampled population and the hypothesized population mean ($P = <0.001$). Therefore, it is safe to accept the null hypothesis. H2c is supported.

H2d: The competence and quality of logistics services in Turkey differs in a negative and a significant manner in comparison to high-income non-OECD countries.

Table 6.15 Descriptive statistics of hypothesis H2d.

Size	Missing	Mean	Std.Dev.	Std.Error	C.I. of Mean
15	0	3.115	0.501	0.129	0.277
Range	Max.	Min.	Median	25%	75%
1.750	4.120	2.370	3.110	2.723	3.465
Skewness	Kurtosis	K-S Dist.	K-S Prob.	SWilk W.	SWilk Prob.
0.419	-0.451	0.133	0.609	0.971	0.875

Table 6.16 One sample t-test of hypothesis H2d.

Normality Test: Passed (P = 0.875)					
N	Missing	Mean	Std.Dev.	SEM	
15	0	3.115	0.501	0.129	

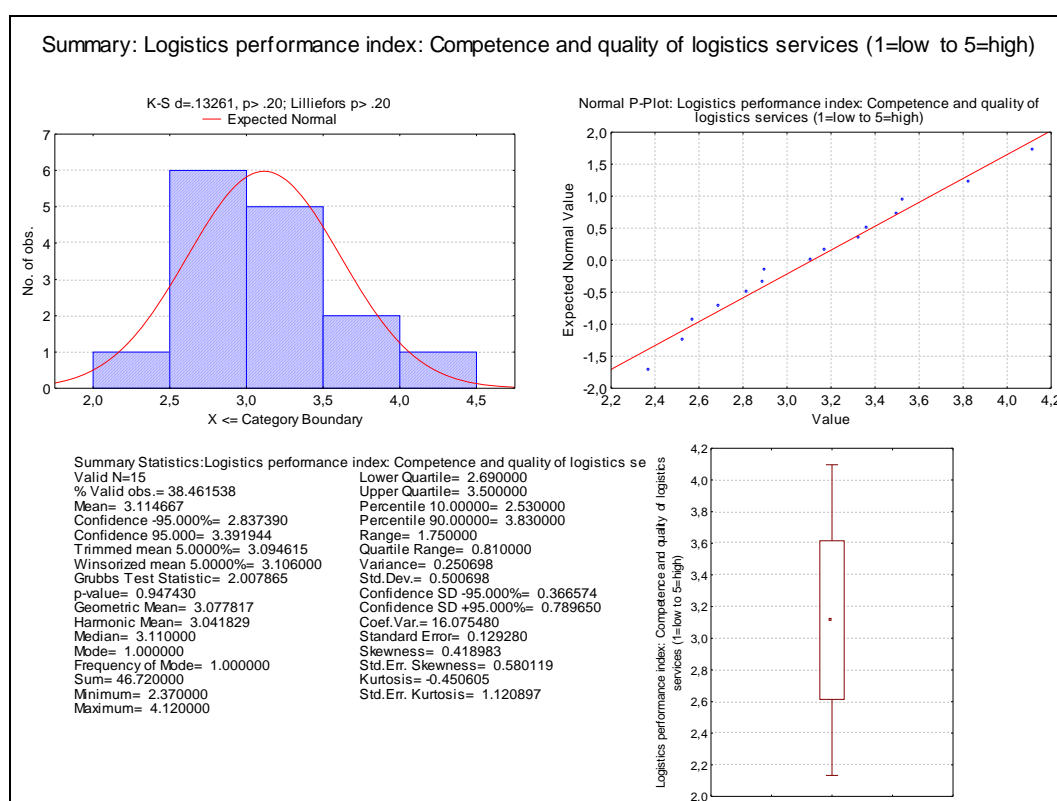

Figure 6.8 Descriptive statistics of the data

Hypothesized population mean is 3.230 and $t = -0.892$ with 14 degrees of freedom ($P = 0.387$). 95 percent confidence interval for the population mean: 2.837 to 3.392 and the power of performed test with $\alpha = 0.050$: 0.132 (See the figure and tables above).

The power of the performed test (0.132) is below the desired power of 0.800. Less than desired power indicates it is less likely to detect a difference when one actually exists. Negative results should be interpreted cautiously.

The difference between the mean of the sampled population and the hypothesized population mean is not great enough to reject the hypothesis that the difference is only due to random sample variability. There is not a significant difference between the two means ($P = 0.387$). Therefore, it is safe to reject the null hypothesis. The competence and quality of logistics services in Turkey does not differ in a significant manner in comparison to high-income non-OECD countries. H2d is rejected.

H3a: The ease of arranging competitively priced shipments of logistics services in Turkey differs in a positive and a significant manner in comparison to lower middle-income countries.

Table 6.17 Descriptive statistics of hypothesis H3a.

Size	Missing	Mean	Std.Dev.	Std.Error	C.I. of Mean
40	0	2.655	0.349	0.0552	0.112
Range	Max.	Min.	Median	25%	75%
1.290	3.400	2.110	2.595	2.425	2.865
Skewness	Kurtosis	K-S Dist.	K-S Prob.	SWilk W.	SWilk Prob.
0.510	-0.496	0.107	0.288	0.954	0.101

Table 6.18 One sample t-test of hypothesis H3a.

Normality Test:		Passed		(P = 0.101)	
N	Missing	Mean	Std.Dev.	SEM	
40	0	2.655	0.349	0.0552	

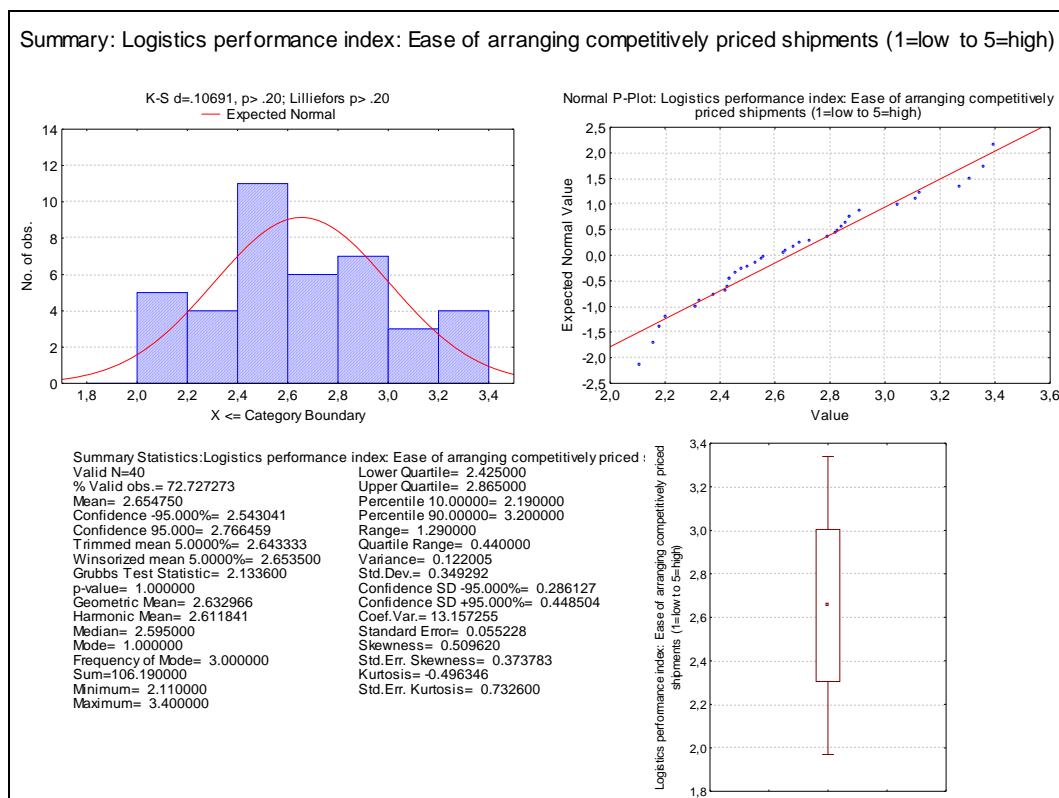

Figure 6.9 Descriptive statistics of the data

Hypothesized population mean is 3.150 and $t = -8.967$ with 39 degrees of freedom ($P = <0.001$). 95 percent confidence interval for the population mean: 2.543 to 2.766 and the power of performed test with $\alpha = 0.050$: 1.000 (See the figure and tables above).

There is a statistically significant difference between the mean of the sampled population and the hypothesized population mean ($P = <0.001$). Therefore, it is safe to accept the null hypothesis. H3a is supported.

H3b: The ease of arranging competitively priced shipments of logistics services in Turkey has no significant difference in comparison to upper middle-income group.

Table 6.19 Descriptive statistics of hypothesis H3b.

Size	Missing	Mean	Std.Dev.	Std.Error	C.I. of Mean
34	0	2.844	0.386	0.0662	0.135
Range	Max.	Min.	Median	25%	75%
1.590	3.500	1.910	2.830	2.590	3.190
Skewness	Kurtosis	K-S Dist.	K-S Prob.	SWilk W.	SWilk Prob.
-0.364	-0.366	0.0855	0.692	0.974	0.564

Table 6.20 One sample t-test of hypothesis H3b.

Normality Test:		Passed (P = 0.564)		
N	Missing	Mean	Std.Dev.	SEM
34	0	2.844	0.386	0.0662

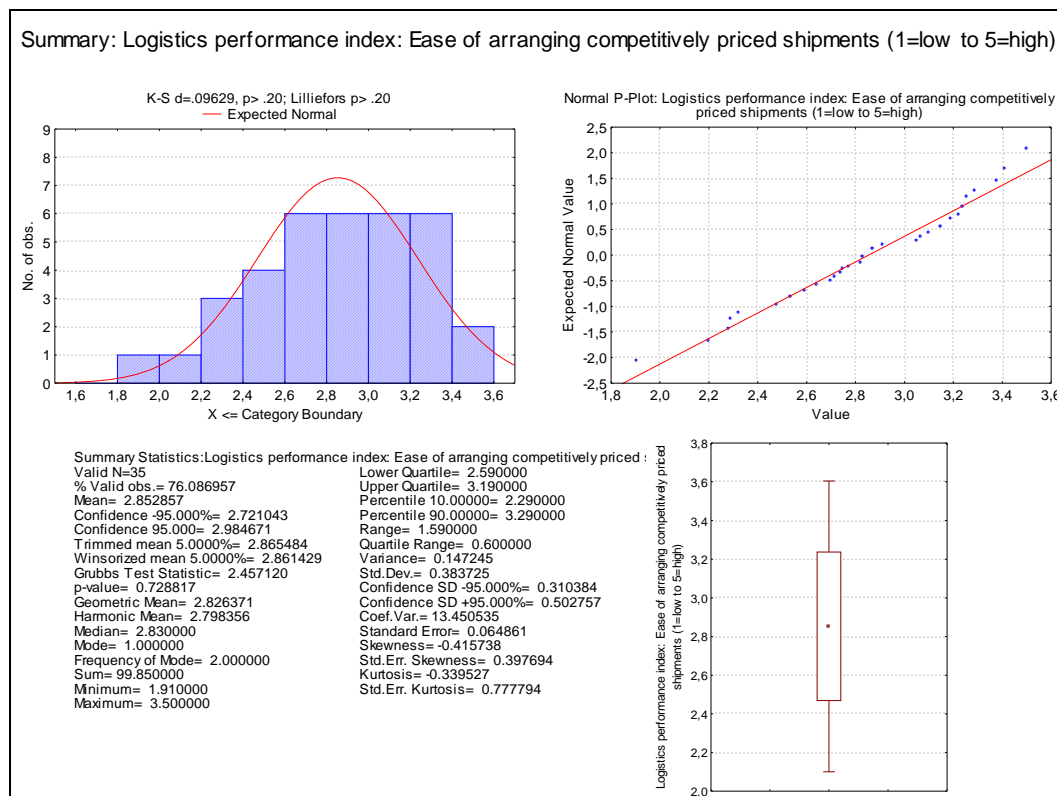

Figure 6.10 Descriptive statistics of the data

Hypothesized population mean is 3.150 and $t = -4.621$ with 33 degrees of freedom ($P = <0.001$). 95 percent confidence interval for the population mean: 2.709 to 2.979 and the power of performed test with $\alpha = 0.050$: 0.994 (See the figure and tables above).

There is a statistically significant difference between the mean of the sampled population and the hypothesized population mean ($P = <0.001$). Therefore, it is safe to reject the null hypothesis and accept the alternative hypothesis. H3b is rejected.

H3c: The ease of arranging competitively priced shipments of logistics services in Turkey differs in a negative and a significant manner in comparison to high-income OECD countries.

Table 6.21 Descriptive statistics of hypothesis H3c.

Size	Missing	Mean	Std.Dev.	Std.Error	C.I. of Mean
27	0	3.378	0.283	0.0545	0.112
Range	Max.	Min.	Median	25%	75%
1.050	3.830	2.780	3.360	3.210	3.648
Skewness	Kurtosis	K-S Dist.	K-S Prob.	SWilk W.	SWilk Prob.
-0.278	-0.561	0.0992	0.643	0.971	0.625

Table 6.22 One sample t-test of hypothesis H3c.

Normality Test: Passed (P = 0.625)					
N	Missing	Mean	Std.Dev.	SEM	
27	0	3.378	0.283	0.0545	

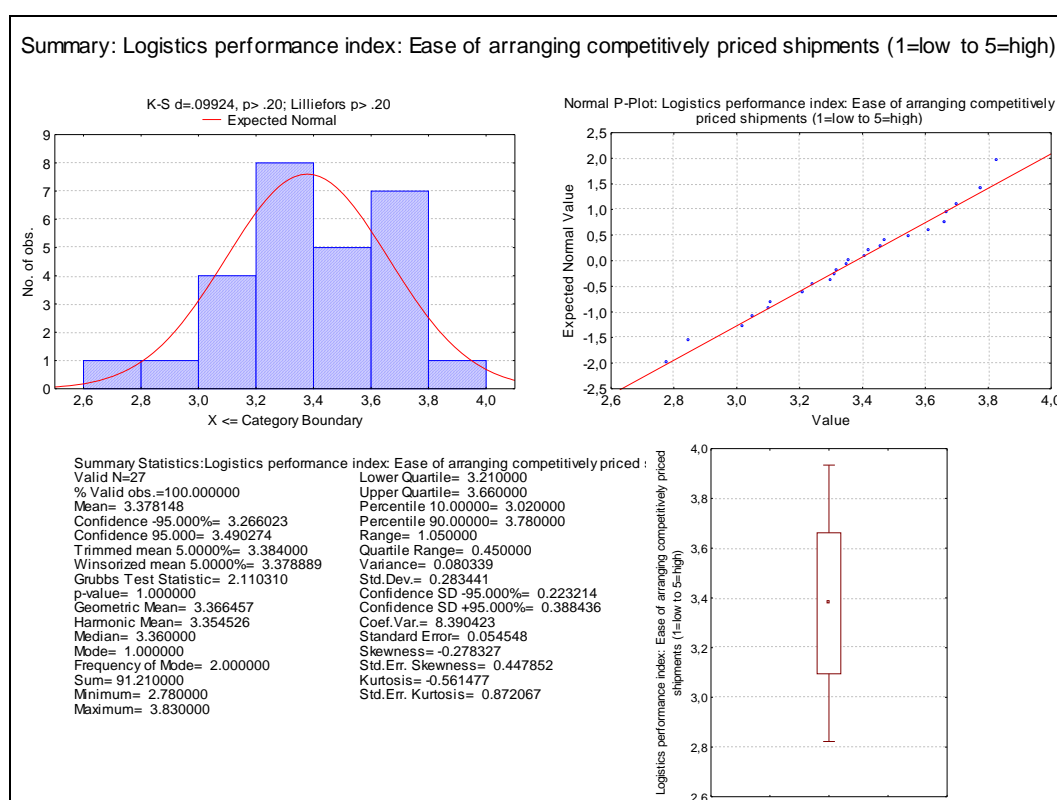

Figure 6.11 Descriptive statistics of the data

Hypothesized population mean is 3.150 and $t = 4.183$ with 26 degrees of freedom ($P = <0.001$). 95 percent confidence interval for the population mean: 3.266 to 3.490 and the power of performed test with $\alpha = 0.050$: 0.980 (See the figure and tables above).

There is a statistically significant difference between the mean of the sampled population and the hypothesized population mean ($P = <0.001$). Therefore, it is safe to accept the null hypothesis. H3c is supported.

H3d: The ease of arranging competitively priced shipments of logistics services in Turkey differs in a negative and a significant manner in comparison to high-income non-OECD countries.

Table 6.23 Descriptive statistics of hypothesis H3d.

Size	Missing	Mean	Std.Dev.	Std.Error	C.I. of Mean
15	0	3.073	0.386	0.0996	0.214
Range	Max.	Min.	Median	25%	75%
1.550	3.860	2.310	3.050	2.857	3.170
Skewness	Kurtosis	K-S Dist.	K-S Prob.	SWilk W.	SWilk Prob.
0.329	0.736	0.200	0.105	0.959	0.679

Table 6.24 One sample t-test of hypothesis H3d.

Normality Test:		Passed (P = 0.679)			
N	Missing	Mean	Std.Dev.	SEM	
15	0	3.073	0.386	0.0996	

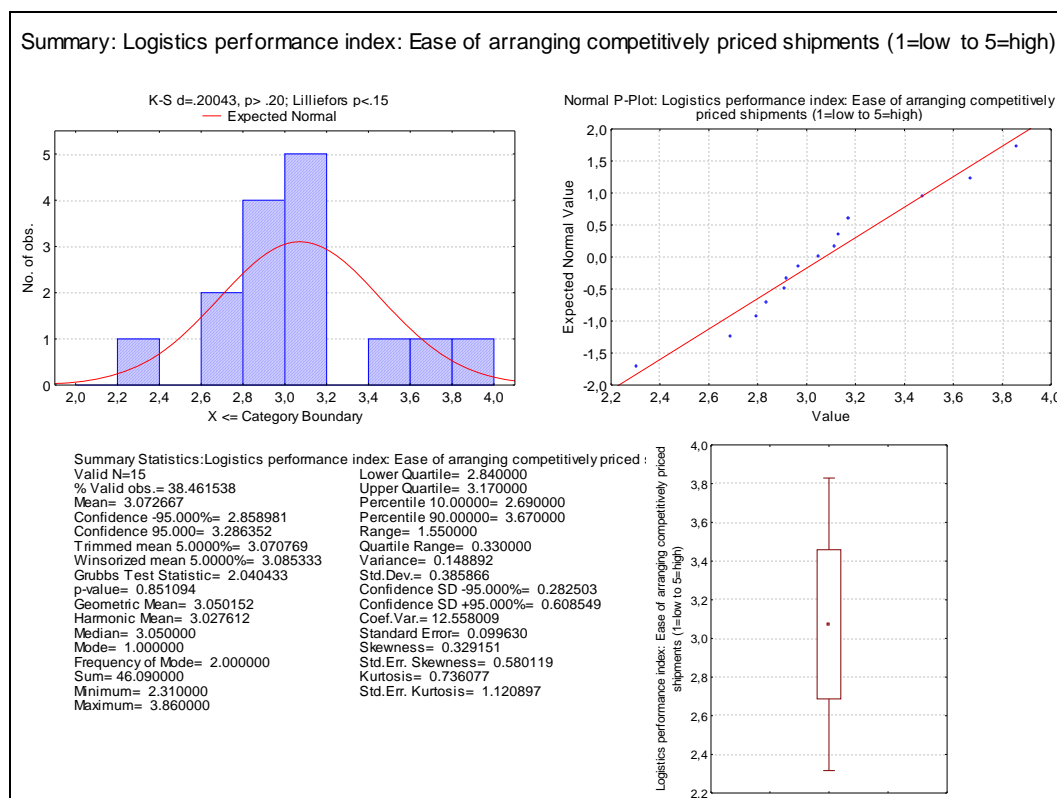

Figure 6.12 Descriptive statistics of the data

Hypothesized population mean is 3.150 and $t = -0.776$ with 14 degrees of freedom ($P = 0.451$). 95 percent confidence interval for the population mean: 2.859 to 3.286 and the power of performed test with $\alpha = 0.050$: 0.112 (See the figure and tables above)

The power of the performed test (0.112) is below the desired power of 0.800. Less than desired power indicates it is less likely to detect a difference when one actually exists. Negative results should be interpreted cautiously.

The difference between the mean of the sampled population and the hypothesized population mean is not great enough to reject the hypothesis that the difference is only due to random sample variability. There is not a significant difference between the two means ($P = 0.451$). Therefore, it is safe to reject the null hypothesis. The ease of arranging competitively priced shipments of logistics services in Turkey differs in a negative but not in a significant manner in comparison to high-income non-OECD countries. H3d is rejected.

H4a: The efficiency of customs clearance process of logistics services in Turkey differs in a positive and a significant manner in comparison to lower middle-income countries.

Table 6.25 Descriptive statistics of hypothesis H4a.

Size	Missing	Mean	Std.Dev.	Std.Error	C.I. of Mean
40	0	2.241	0.280	0.0442	0.0895
Range	Max.	Min.	Median	25%	75%
1.410	3.160	1.750	2.165	2.070	2.370
Skewness	Kurtosis	K-S Dist.	K-S Prob.	SWilk W.	SWilk Prob.
1.423	3.025	0.140	0.048	0.886	<0.001

Table 6.26 One sample t-test of hypothesis H4a.

Normality Test:		Failed (P < 0.050)		
N	Missing	Mean	Std.Dev.	SEM
40	0	2.241	0.280	0.0442

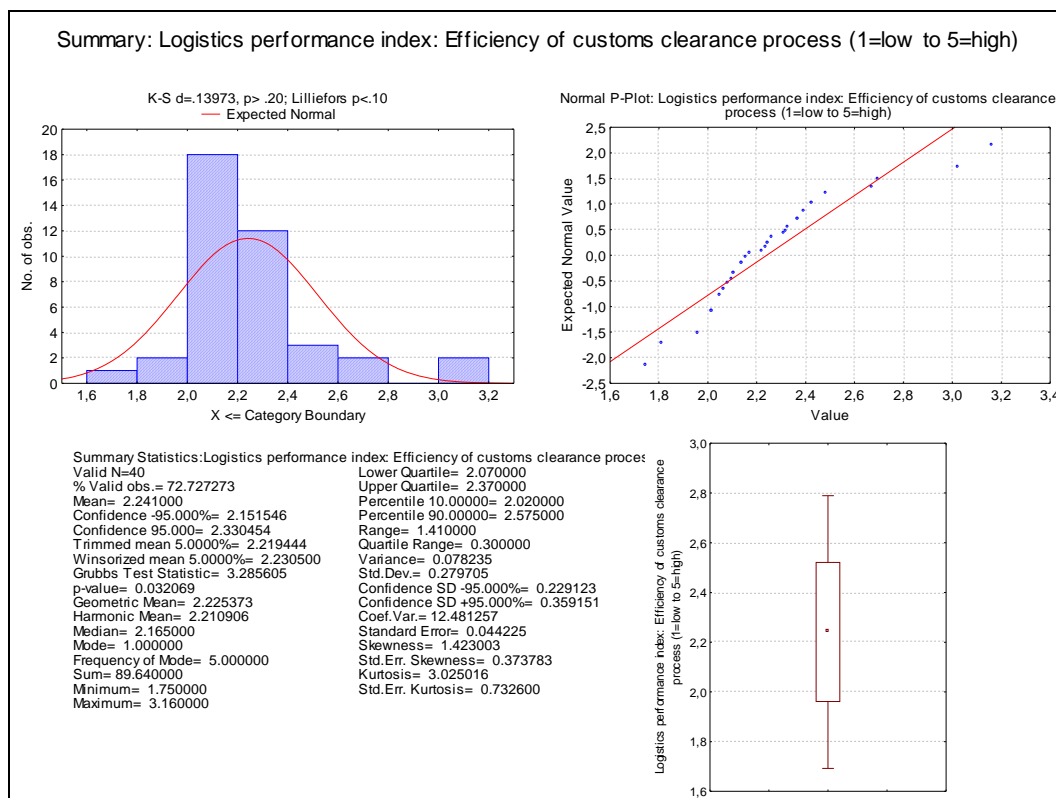

Figure 6.13 Descriptive statistics of the data

Hypothesized population mean is 2.820 and $t = -13.092$ with 39 degrees of freedom ($P = <0.001$). 95 percent confidence interval for the population mean: 2.152 to 2.330 and the power of performed test with $\alpha = 0.050$: 1.000 (See the figure and tables above).

There is a statistically significant difference between the mean of the sampled population and the hypothesized population mean ($P = <0.001$). Therefore, it is safe to accept the null hypothesis. H4a is supported.

H4b: The efficiency of customs clearance process of logistics services in Turkey has no significant difference in comparison to upper middle-income group.

Table 6.27 Descriptive statistics of hypothesis H4b.

Size	Missing	Mean	Std.Dev.	Std.Error	C.I. of Mean
34	0	2.464	0.406	0.0697	0.142
Range	Max.	Min.	Median	25%	75%
1.590	3.270	1.680	2.500	2.150	2.710
Skewness	Kurtosis	K-S Dist.	K-S Prob.	SWilk W.	SWilk Prob.
0.204	-0.527	0.0735	0.822	0.980	0.776

Table 6.28 One sample t-test of hypothesis H4b.

Normality Test:		Passed (P = 0.776)			
N	Missing	Mean	Std.Dev.	SEM	
34	0	2.464	0.406	0.0697	

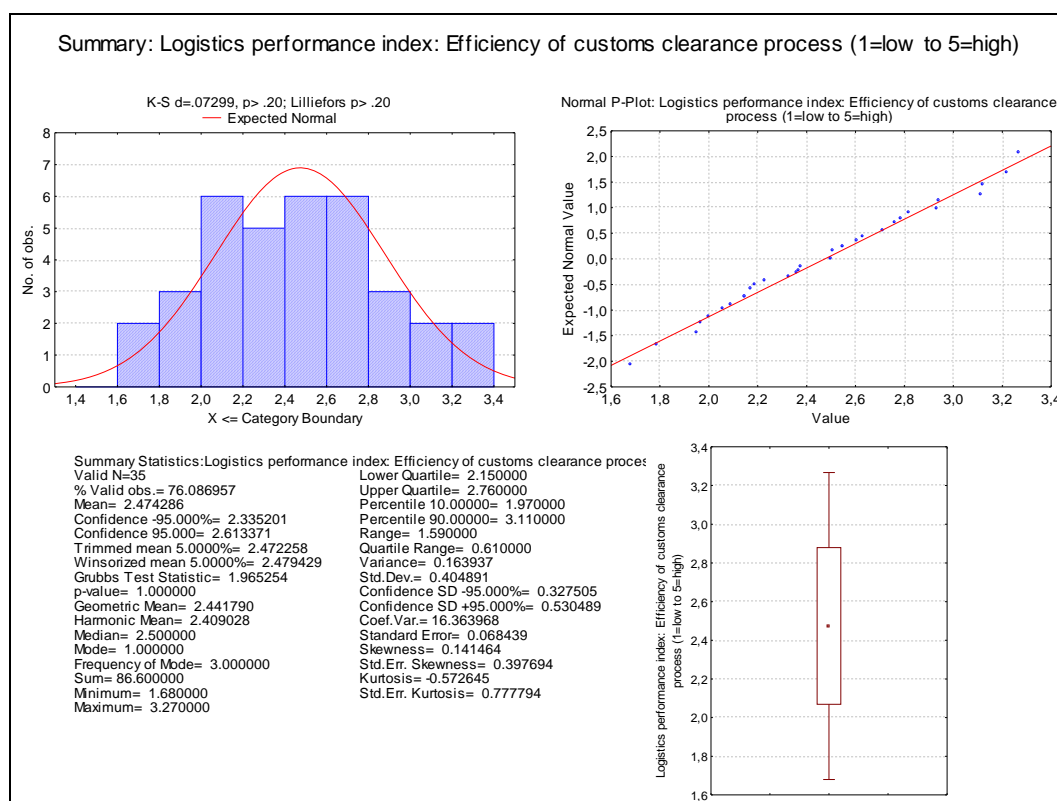

Figure 6.14 Descriptive statistics of the data

Hypothesized population mean is 2.820 and $t = -5.106$ with 33 degrees of freedom ($P = <0.001$). 95 percent confidence interval for the population mean: 2.322 to 2.606 and the power of performed test with $\alpha = 0.050$: 0.999 (See the figure and tables above).

There is a statistically significant difference between the mean of the sampled population and the hypothesized population mean ($P = <0.001$). Therefore, it is safe to reject the null hypothesis. H4b is rejected.

H4c: The efficiency of customs clearance process of logistics services in Turkey differs in a negative and a significant manner in comparison to high-income OECD countries.

Table 6.29 Descriptive statistics of hypothesis H4c.

Size	Missing	Mean	Std.Dev.	Std.Error	C.I. of Mean
27	0	3.550	0.380	0.0732	0.150
Range	Max.	Min.	Median	25%	75%
1.560	4.040	2.480	3.640	3.342	3.820
Skewness	Kurtosis	K-S Dist.	K-S Prob.	SWilk W.	SWilk Prob.
-1.261	1.499	0.161	0.069	0.894	0.010

Table 6.30 One sample t-test of hypothesis H4c.

Normality Test:		Failed (P < 0.050)		
N	Missing	Mean	Std.Dev.	SEM
27	0	3.550	0.380	0.0732

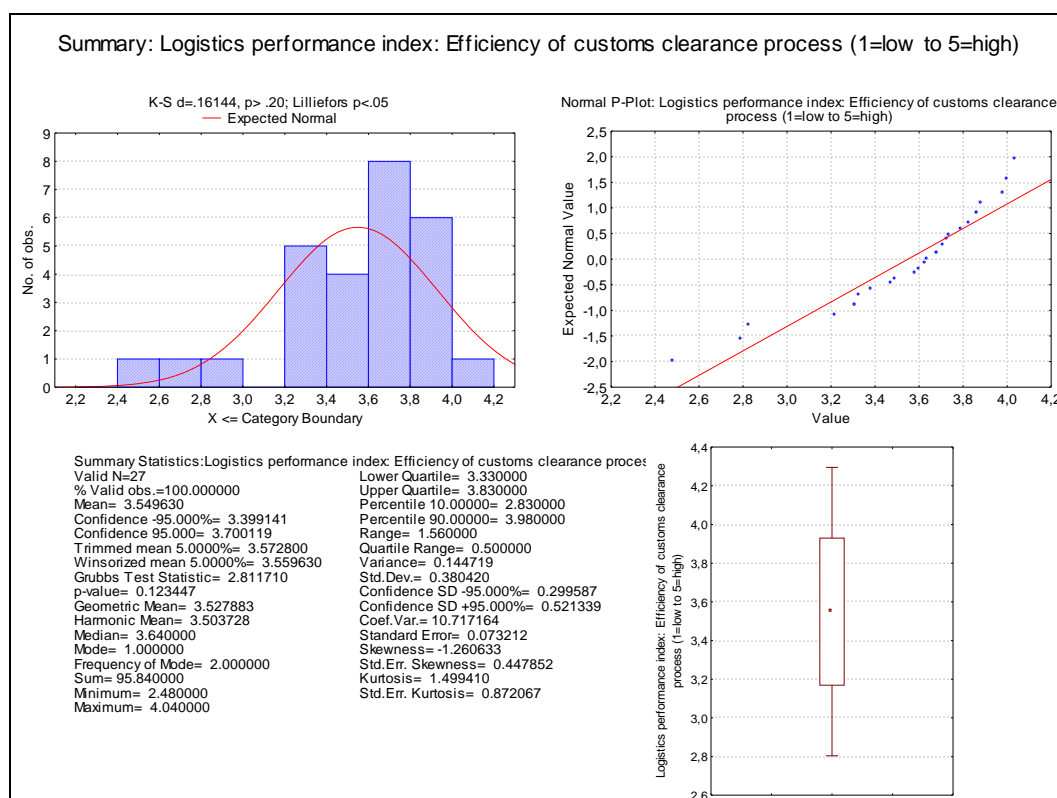

Figure 6.15 Descriptive statistics of the data

Hypothesized population mean is 2.820 and $t = 9.966$ with 26 degrees of freedom ($P = <0.001$). 95 percent confidence interval for the population mean: 3.399 to 3.700 and the power of performed test with $\alpha = 0.050$: 1.000 (See the figure and tables above).

There is a statistically significant difference between the mean of the sampled population and the hypothesized population mean ($P = <0.001$). Therefore, it is safe to accept the null hypothesis. H4c is supported.

H4d: The efficiency of customs clearance process of logistics services in Turkey differs in a negative and a significant manner in comparison to high-income non-OECD countries.

Table 6.31 Descriptive statistics of hypothesis H4d.

Size	Missing	Mean	Std.Dev.	Std.Error	C.I. of Mean
15	0	3.025	0.503	0.130	0.278
Range	Max.	Min.	Median	25%	75%
1.770	4.020	2.250	3.030	2.628	3.320
Skewness	Kurtosis	K-S Dist.	K-S Prob.	SWilk W.	SWilk Prob.
0.462	-0.193	0.143	0.511	0.966	0.796

Table 6.32 One sample t-test of hypothesis H4d.

Normality Test: Passed (P = 0.796)					
N	Missing	Mean	Std.Dev.	SEM	
15	0	3.025	0.503	0.130	

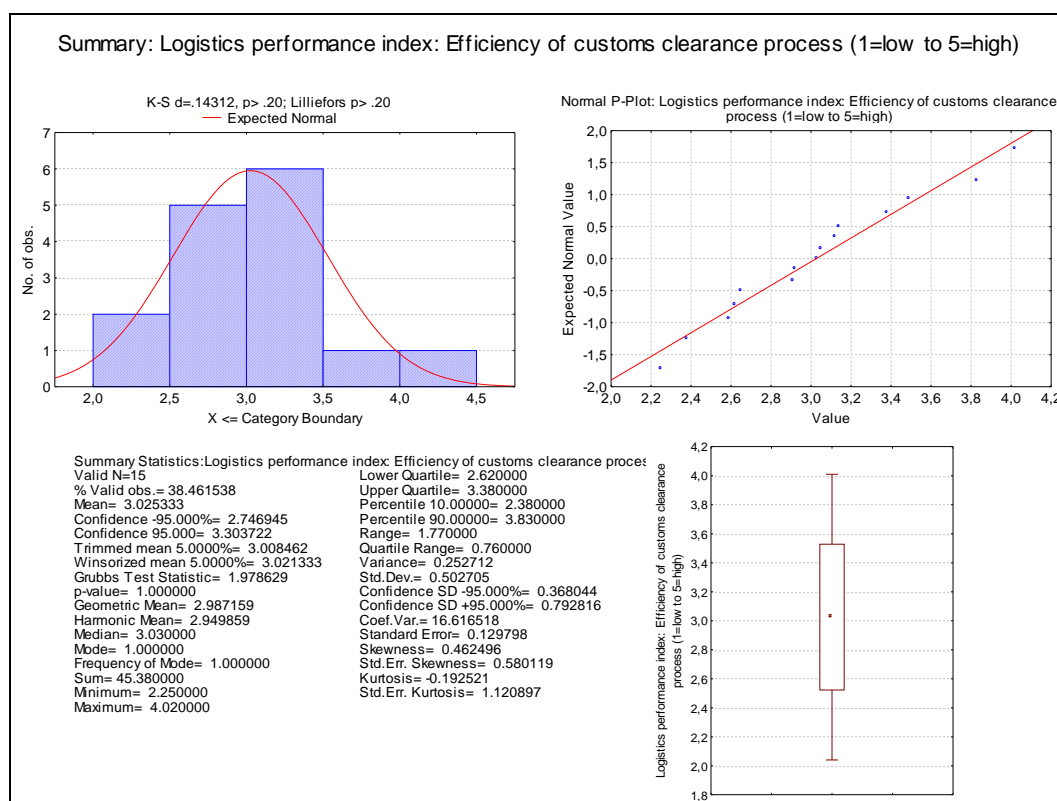

Figure 6.16 Descriptive statistics of the data

Hypothesized population mean is 2.820 and $t = 1.582$ with 14 degrees of freedom ($P = 0.136$). 95 percent confidence interval for the population mean: 2.747 to 3.304 and the power of performed test with $\alpha = 0.050$: 0.314 (See the figure and tables above).

The power of the performed test (0.314) is below the desired power of 0.800. Less than desired power indicates it is less likely to detect a difference when one actually exists. Negative results should be interpreted cautiously.

The difference between the mean of the sampled population and the hypothesized population mean is not great enough to reject the hypothesis that the difference is only due to random sample variability. There is not a significant difference between the two means ($P = 0.136$). Therefore, it is safe to reject the null hypothesis. The efficiency of customs clearance process of logistics services in Turkey differs in a positive but not in a significant manner in comparison to high-income non-OECD countries. H4d is rejected.

H5a: The frequency with which shipments reach consignee within scheduled or expected time in Turkey differs in a positive and a significant manner in comparison to lower middle-income countries.

Table 6.33 Descriptive statistics of hypothesis H5a.

Size	Missing	Mean	Std.Dev.	Std.Error	C.I. of Mean
40	0	3.249	0.369	0.0583	0.118
Range	Max.	Min.	Median	25%	75%
1.510	4.000	2.490	3.205	3.030	3.515
Skewness	Kurtosis	K-S Dist.	K-S Prob.	SWilk W.	SWilk Prob.
-0.00222	-0.392	0.0826	0.644	0.983	0.807

Table 6.34 One sample t-test of hypothesis H5a.

Normality Test: Passed (P = 0.807)					
N	Missing	Mean	Std.Dev.	SEM	
40	0	3.249	0.369	0.0583	

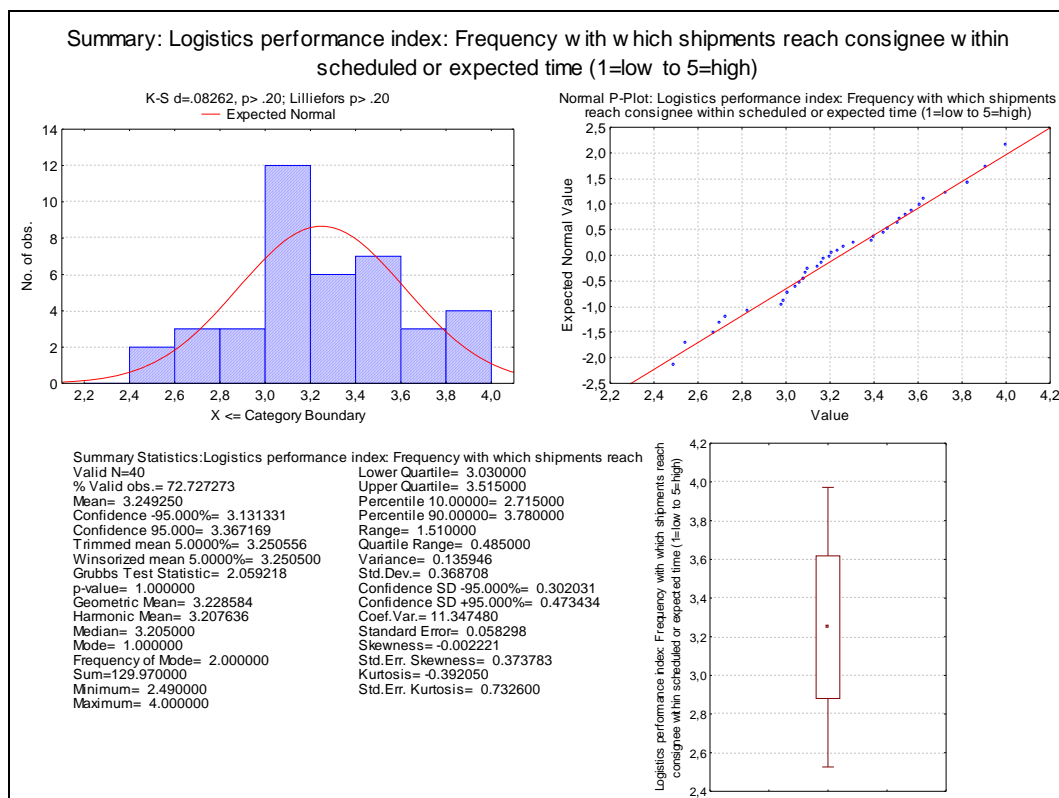

Figure 6.17 Descriptive statistics of the data

Hypothesized population mean is 3.940 and $t = -11.849$ with 39 degrees of freedom ($P = <0.001$). 95 percent confidence interval for the population mean: 3.131 to 3.367 and the power of performed test with $\alpha = 0.050$: 1.000 (See the figure and tables above).

There is a statistically significant difference between the mean of the sampled population and the hypothesized population mean ($P = <0.001$). Therefore, it is safe to accept the null hypothesis. H5a is supported.

H5b: The frequency with which shipments reach consignee within scheduled or expected time in Turkey has no significant difference in comparison to upper middle-income group.

Table 6.35 Descriptive statistics of hypothesis H5b.

Size	Missing	Mean	Std.Dev.	Std.Error	C.I. of Mean
34	0	3.328	0.514	0.0881	0.179
Range	Max.	Min.	Median	25%	75%
2.140	4.520	2.380	3.240	2.910	3.760
Skewness	Kurtosis	K-S Dist.	K-S Prob.	SWilk W.	SWilk Prob.
0.163	-0.566	0.0951	0.561	0.974	0.573

Table 6.36 One sample t-test of hypothesis H5b.

Normality Test:		Passed	(P = 0.573)		
N	Missing	Mean	Std.Dev.	SEM	
34	0	3.328	0.514	0.0881	

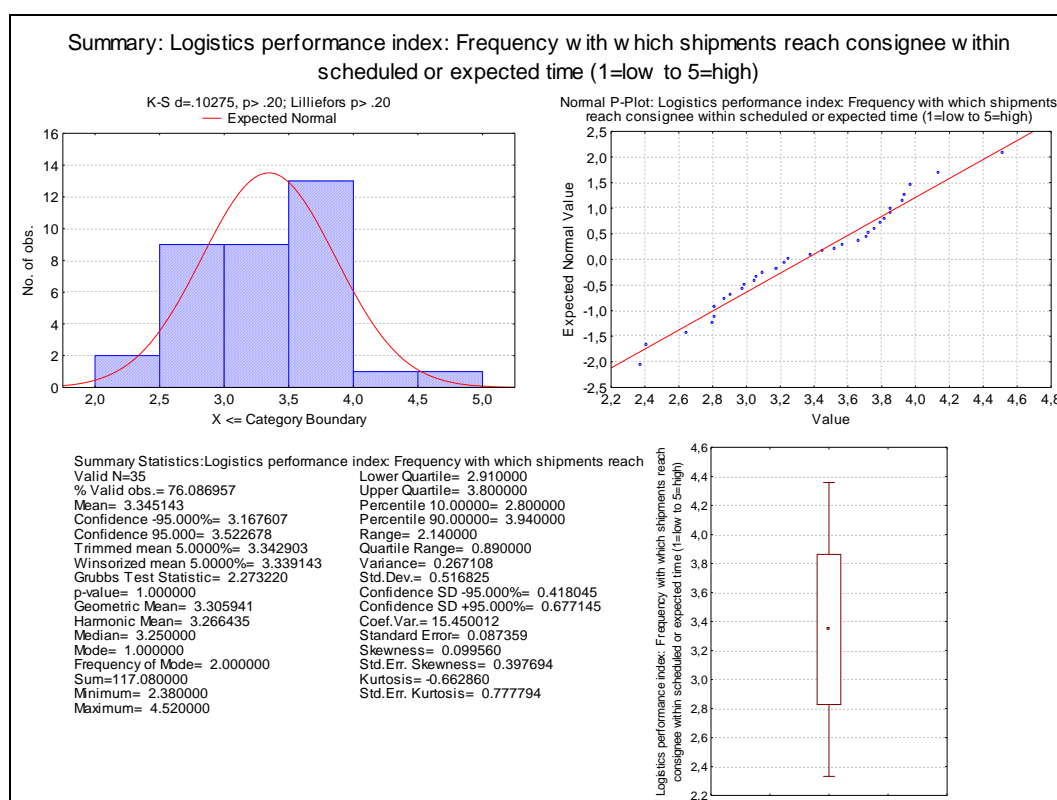

Figure 6.18 Descriptive statistics of the data

Hypothesized population mean is 3.940 and $t = -6.947$ with 33 degrees of freedom ($P = <0.001$). 95 percent confidence interval for the population mean: 3.148 to 3.507 and the power of performed test with $\alpha = 0.050$: 1.000 (See the figure and tables above)

There is a statistically significant difference between the mean of the sampled population and the hypothesized population mean ($P = <0.001$). Therefore, it is safe to reject the null hypothesis and accept the alternative hypothesis. H5b is rejected.

H5c: The frequency with which shipments reach consignee within scheduled or expected time in Turkey differs in a negative and a significant manner in comparison to high-income OECD countries.

Table 6.37 Descriptive statistics of hypothesis H5c.

Size	Missing	Mean	Std.Dev.	Std.Error	C.I. of Mean
27	0	4.146	0.316	0.0607	0.125
Range	Max.	Min.	Median	25%	75%
1.310	4.580	3.270	4.190	4.080	4.370
Skewness	Kurtosis	K-S Dist.	K-S Prob.	SWilk W.	SWilk Prob.
-1.324	1.600	0.195	0.010	0.882	0.005

Table 6.38 One sample t-test of hypothesis H5c.

Normality Test:		Failed	(P < 0.050)		
N	Missing	Mean	Std.Dev.	SEM	
27	0	4.146	0.316	0.0607	

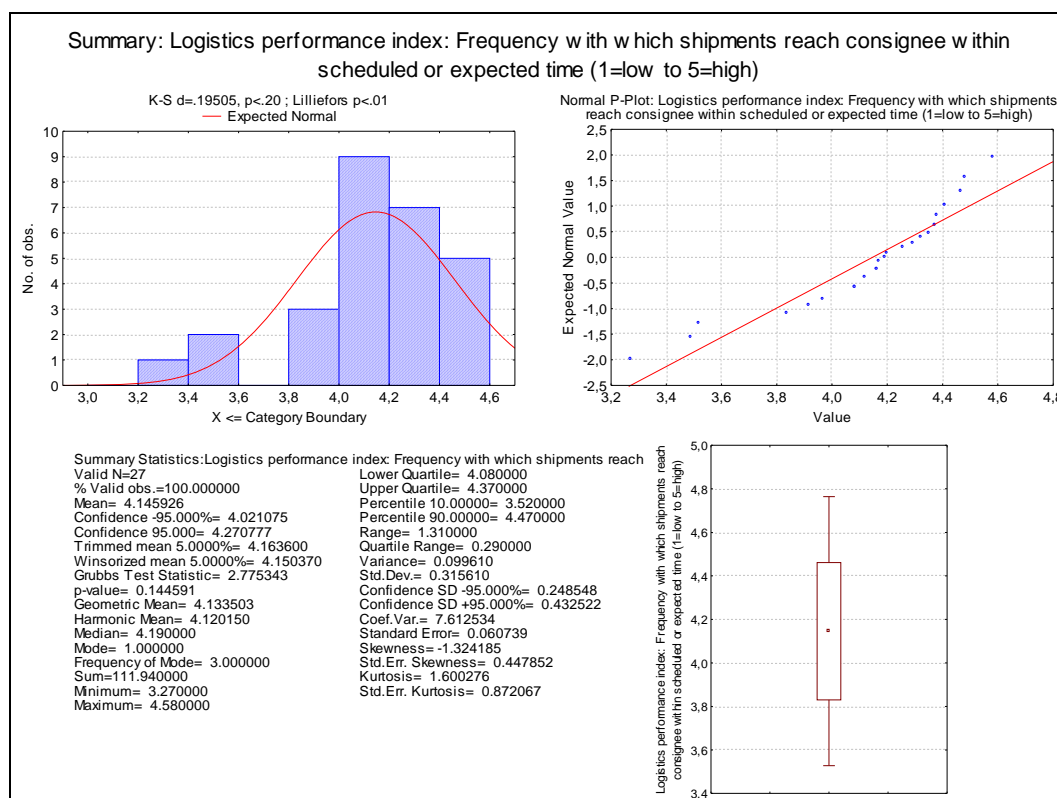

Figure 6.19 Descriptive statistics of the data

Hypothesized population mean is 3.940 and $t = 3.390$ with 26 degrees of freedom ($P = 0.002$). 95 percent confidence interval for the population mean: 4.021 to 4.271 and the power of performed test with $\alpha = 0.050$: 0.904 (See the figure and tables above).

There is a statistically significant difference between the mean of the sampled population and the hypothesized population mean ($P = 0.002$). Therefore, it is safe to accept the null hypothesis. H5c is supported.

H5d: The frequency with which shipments reach consignee within scheduled or expected time in Turkey differs in a negative and a significant manner in comparison to high-income non-OECD countries.

Table 6.39 Descriptive statistics of hypothesis H5d.

Size	Missing	Mean	Std.Dev.	Std.Error	C.I. of Mean
15	0	3.684	0.366	0.0944	0.203
Range	Max.	Min.	Median	25%	75%
1.210	4.230	3.020	3.770	3.445	3.940
Skewness	Kurtosis	K-S Dist.	K-S Prob.	SWilk W.	SWilk Prob.
-0.511	-0.668	0.162	0.339	0.948	0.496

Table 6.40 One sample t-test of hypothesis H5d.

Normality Test:		Passed (P = 0.496)			
N	Missing	Mean	Std.Dev.	SEM	
15	0	3.684	0.366	0.0944	

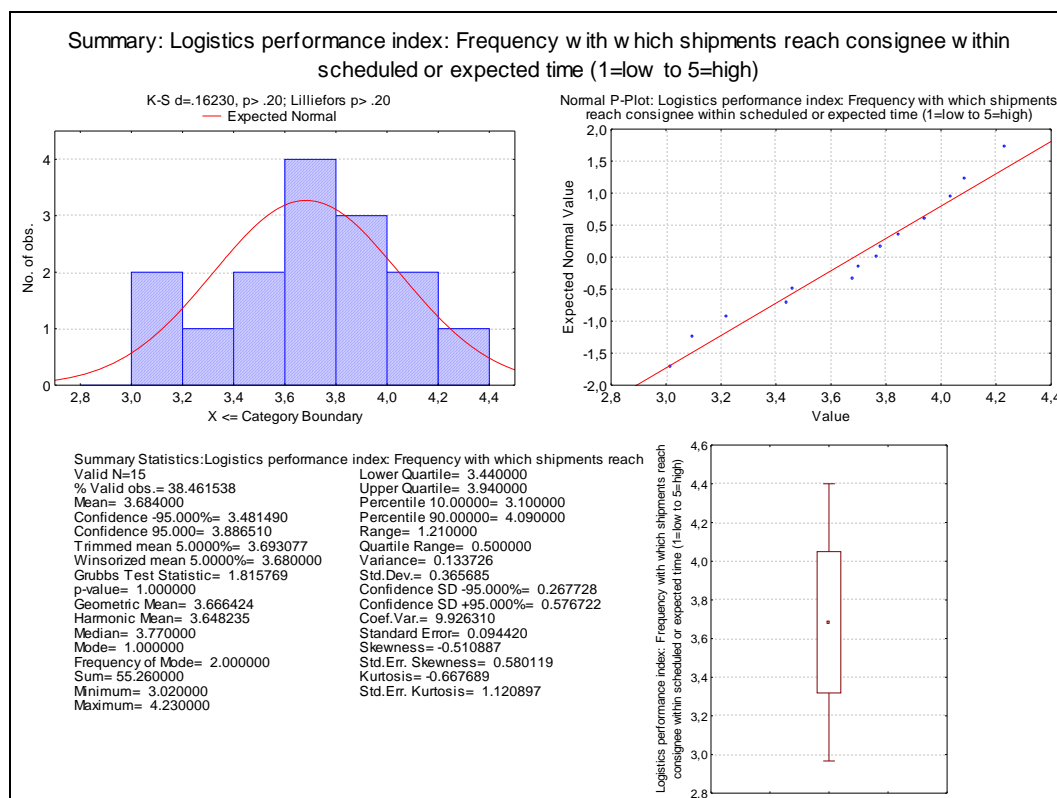

Figure 6.20 Descriptive statistics of the data

Hypothesized population mean is 3.940 and $t = -2.711$ with 14 degrees of freedom ($P = 0.017$). 95 percent confidence interval for the population mean: 3.481 to 3.887 and the power of performed test with $\alpha = 0.050$: 0.713 (See the figure and tables above).

There is a statistically significant difference between the mean of the sampled population and the hypothesized population mean ($P = 0.017$). Therefore, it is safe to reject the null hypothesis. The frequency with which shipments reach consignee within scheduled or expected time in Turkey differs in a positive and a significant manner in comparison to high-income non-OECD countries. H_5d is rejected.

H6a: The quality of trade and transport-related infrastructure in Turkey differs in a positive and a significant manner in comparison to lower middle-income countries.

Table 6.41 Descriptive statistics of hypothesis H6a.

Size	Missing	Mean	Std.Dev.	Std.Error	C.I. of Mean
40	0	2.277	0.377	0.0596	0.121
Range	Max.	Min.	Median	25%	75%
1.920	3.540	1.620	2.240	2.065	2.440
Skewness	Kurtosis	K-S Dist.	K-S Prob.	SWilk W.	SWilk Prob.
1.036	2.573	0.148	0.028	0.929	0.015

Table 6.42 One sample t-test of hypothesis H6a.

Normality Test:		Failed		(P < 0.050)	
N	Missing	Mean	Std.Dev.	SEM	
40	0	2.277	0.377	0.0596	

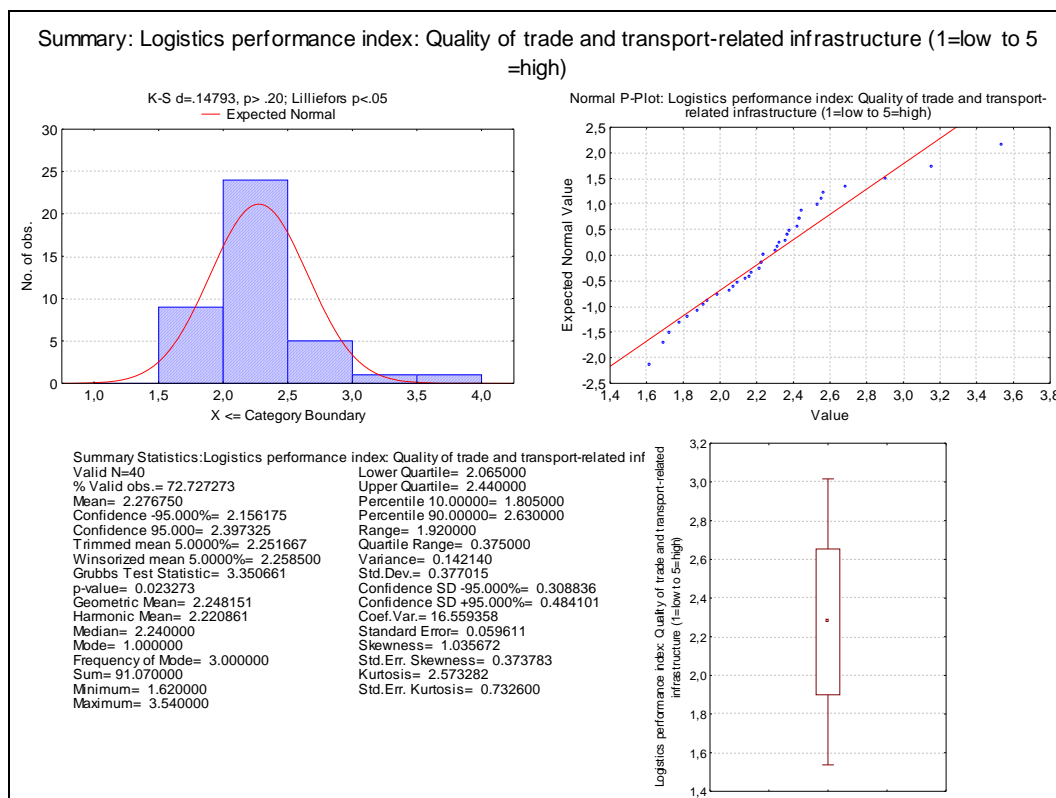

Figure 6.21 Descriptive statistics of the data

Hypothesized population mean is 3.080 and $t = -13.475$ with 39 degrees of freedom ($P = <0.001$). 95 percent confidence interval for the population mean: 2.156 to 2.397 and the power of performed test with $\alpha = 0.050$: 1.000 (See the figure and tables above).

There is a statistically significant difference between the mean of the sampled population and the hypothesized population mean ($P = <0.001$). Therefore, it is safe to accept the null hypothesis. H_0a is supported.

H_{0b}: The quality of trade and transport-related infrastructure in Turkey has no significant difference in comparison to upper middle-income group.

Table 6.43 Descriptive statistics of hypothesis H_{0b}.

Size	Missing	Mean	Std.Dev.	Std.Error	C.I. of Mean
34	0	2.514	0.419	0.0718	0.146
Range	Max.	Min.	Median	25%	75%
1.790	3.500	1.710	2.500	2.220	2.750
Skewness	Kurtosis	K-S Dist.	K-S Prob.	SWilk W.	SWilk Prob.
0.437	-0.0361	0.0780	0.780	0.980	0.763

Table 6.44 One sample t-test of hypothesis H6b.

Normality Test:		Passed (P = 0.763)			
N	Missing	Mean	Std.Dev.	SEM	
34	0	2.514	0.419	0.0718	

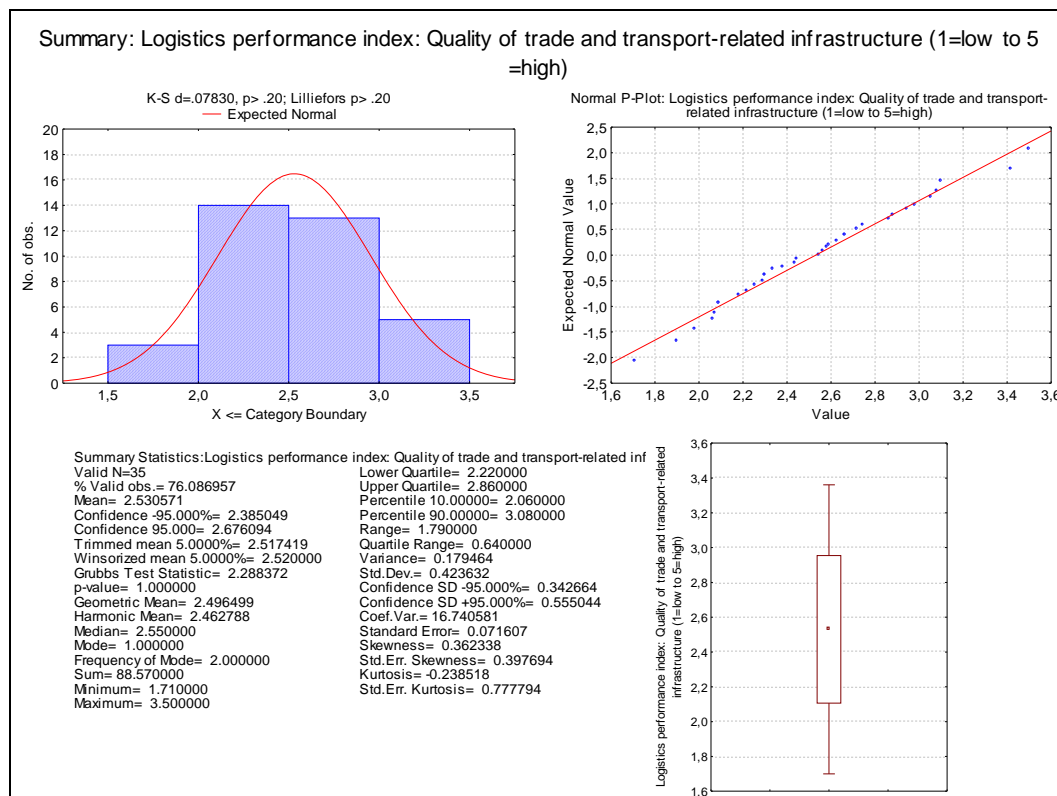

Figure 6.22 Descriptive statistics of the data

Hypothesized population mean is 3.080 and $t = -7.873$ with 33 degrees of freedom ($P = <0.001$). 95 percent confidence interval for the population mean: 2.368 to 2.661 and the power of performed test with $\alpha = 0.050$: 1.000 (See the figure and tables above).

There is a statistically significant difference between the mean of the sampled population and the hypothesized population mean ($P = <0.001$). Therefore, it is safe to reject the null hypothesis. H6b is rejected.

H6c: The quality of trade and transport-related infrastructure in Turkey differs in a negative and a significant manner in comparison to high-income OECD countries.

Table 6.45 Descriptive statistics of hypothesis H6c.

Size	Missing	Mean	Std.Dev.	Std.Error	C.I. of Mean
27	0	3.775	0.414	0.0796	0.164
Range	Max.	Min.	Median	25%	75%
1.400	4.340	2.940	3.950	3.550	4.075
Skewness	Kurtosis	K-S Dist.	K-S Prob.	SWilk W.	SWilk Prob.
-0.689	-0.679	0.183	0.021	0.914	0.028

Table 6.46 One sample t-test of hypothesis H6c.

Normality Test:		Failed	(P < 0.050)	
N	Missing	Mean	Std.Dev.	SEM
27	0	3.775	0.414	0.0796

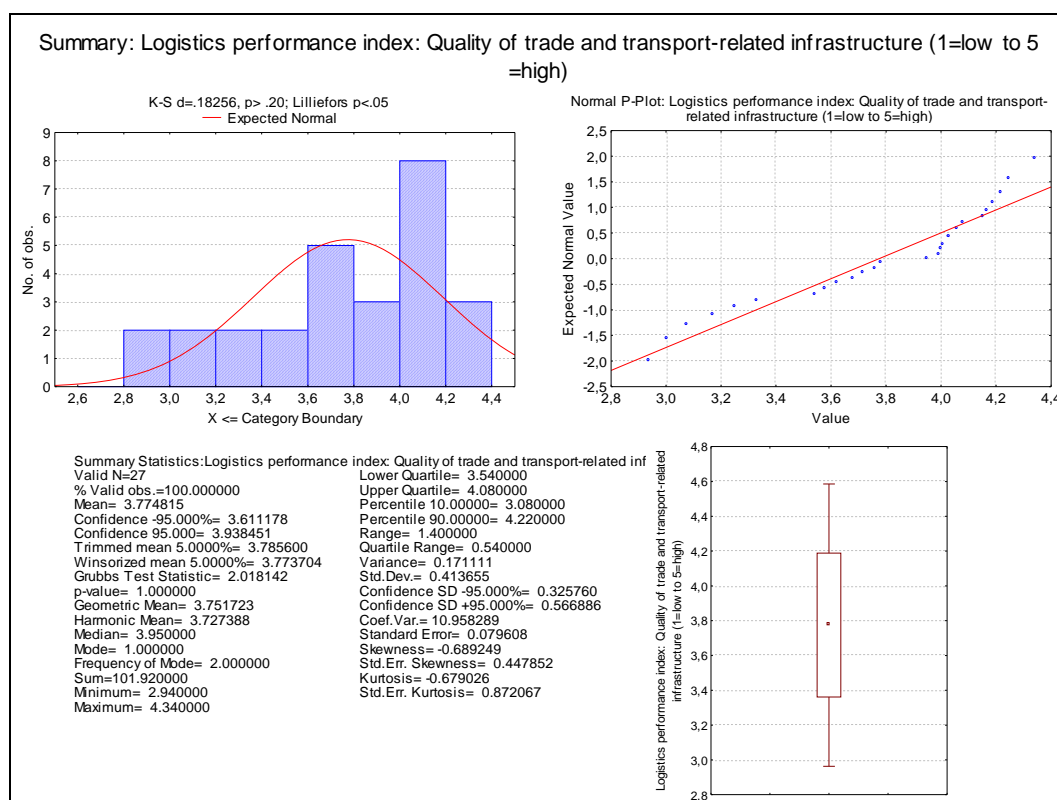

Figure 6.23 Descriptive statistics of the data

Hypothesized population mean is 3.080 and $t = 8.728$ with 26 degrees of freedom ($P = <0.001$). 95 percent confidence interval for the population mean: 3.611 to 3.938 and the power of performed test with $\alpha = 0.050$: 1.000 (See the figure and tables above).

There is a statistically significant difference between the mean of the sampled population and the hypothesized population mean ($P = <0.001$). Therefore, it is safe to accept the null hypothesis. H6c is supported.

H6d: The quality of trade and transport-related infrastructure in Turkey differs in a negative and a significant manner in comparison to high-income non-OECD countries.

Table 6.47 Descriptive statistics of hypothesis H6d.

Size	Missing	Mean	Std.Dev.	Std.Error	C.I. of Mean
15	0	3.159	0.565	0.146	0.313
Range	Max.	Min.	Median	25%	75%
1.860	4.220	2.360	3.060	2.750	3.540
Skewness	Kurtosis	K-S Dist.	K-S Prob.	SWilk W.	SWilk Prob.
0.417	-0.692	0.118	0.732	0.960	0.688

Table 6.48 One sample t-test of hypothesis H6d.

Normality Test:		Passed (P = 0.688)			
N	Missing	Mean	Std.Dev.	SEM	
15	0	3.159	0.565	0.146	

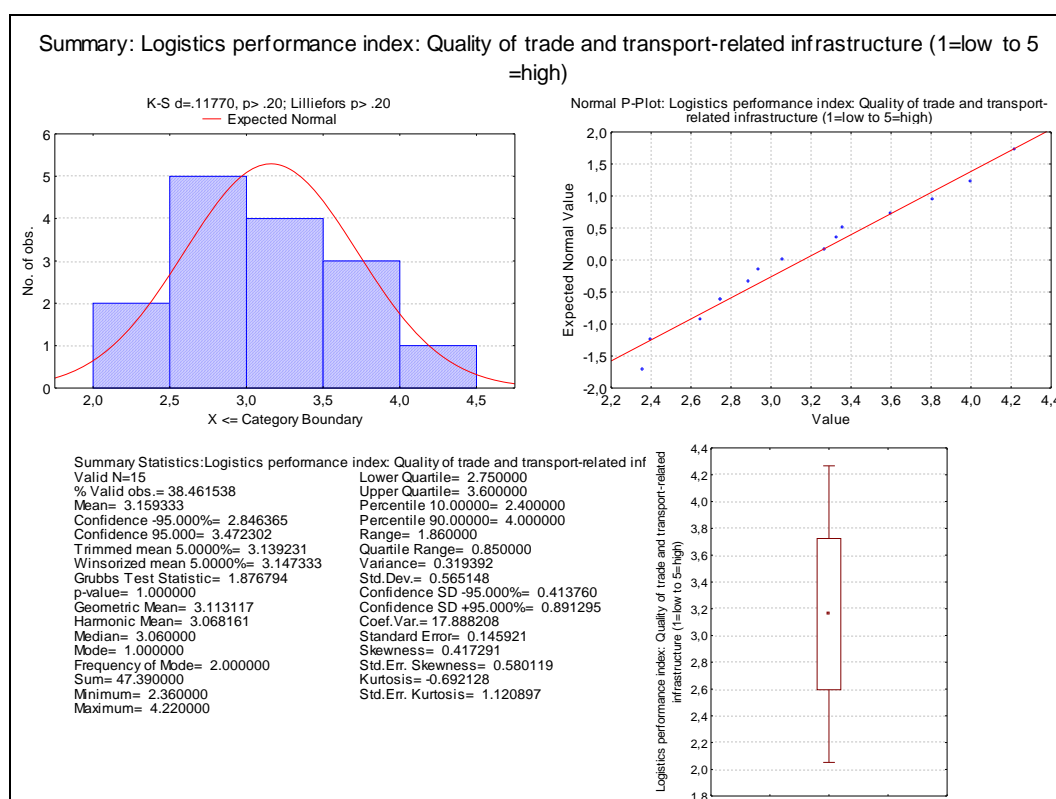

Figure 6.24 Descriptive statistics of the data

Hypothesized population mean is 3.080 and $t = 0.544$ with 14 degrees of freedom ($P = 0.595$). 95 percent confidence interval for the population mean: 2.846 to 3.472 and the power of performed test with $\alpha = 0.050$: 0.080 (See the figure and tables above).

The power of the performed test (0.080) is below the desired power of 0.800. Less than desired power indicates it is less likely to detect a difference when one actually exists. Negative results should be interpreted cautiously.

The difference between the mean of the sampled population and the hypothesized population mean is not great enough to reject the hypothesis that the difference is only due to random sample variability. There is not a significant difference between the two means ($P = 0.595$). Therefore, it is safe to reject the null hypothesis. The quality of trade and transport-related infrastructure in Turkey differs in a negative but not in a significant manner in comparison to high-income non-OECD countries. H6d is rejected.

H7a: The overall logistics services performance index of Turkey differs in a positive and a significant manner in comparison to lower middle-income countries.

Table 6.49 Descriptive statistics of hypothesis H7a.

Size	Missing	Mean	Std.Dev.	Std.Error	C.I. of Mean
40	0	2.594	0.287	0.0454	0.0918
Range	Max.	Min.	Median	25%	75%
1.380	3.490	2.110	2.560	2.405	2.740
Skewness	Kurtosis	K-S Dist.	K-S Prob.	SWilk W.	SWilk Prob.
1.175	1.989	0.136	0.059	0.914	0.005

Table 6.50 One sample t-test of hypothesis H7a.

Normality Test:		Failed	(P < 0.050)		
N	Missing	Mean	Std.Dev.	SEM	
40	0	2.594	0.287	0.0454	

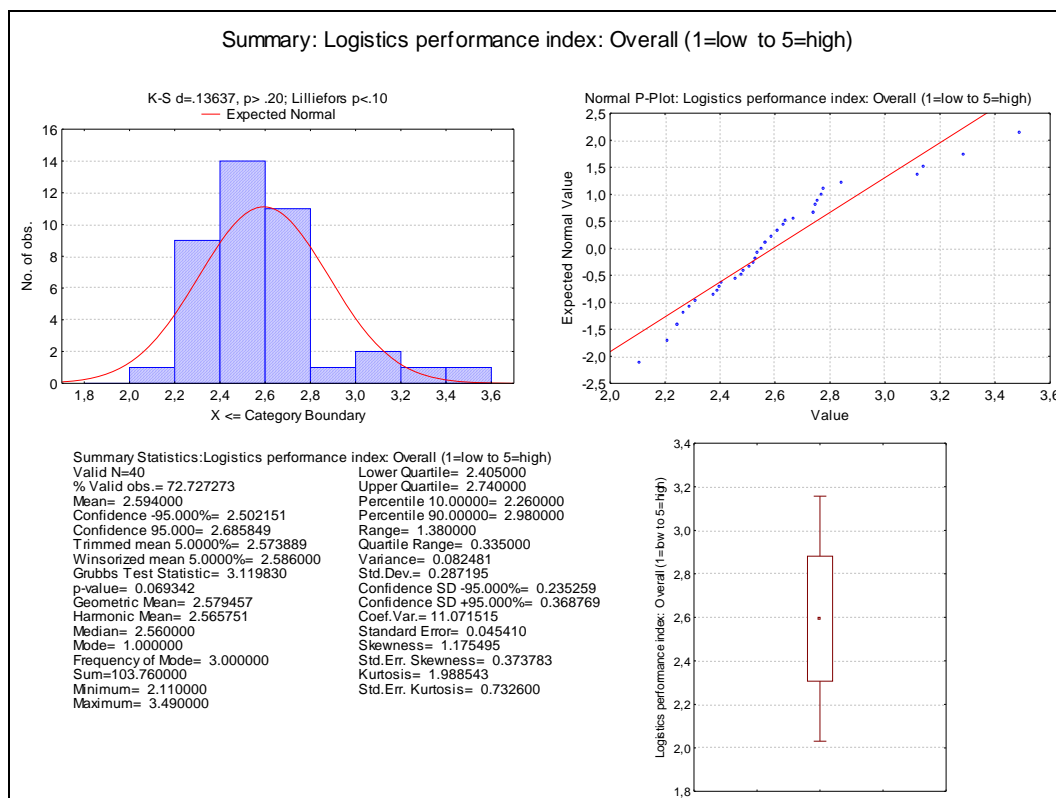

Figure 6.25 Descriptive statistics of the data

Hypothesized population mean is 3.220 and $t = -13.786$ with 39 degrees of freedom ($P = <0.001$). 95 percent confidence interval for the population mean: 2.502 to 2.686 and the power of performed test with $\alpha = 0.050$: 1.000 (See the figure and tables above).

There is a statistically significant difference between the mean of the sampled population and the hypothesized population mean ($P = <0.001$). Therefore, it is safe to accept the null hypothesis. H7a is supported.

H7b: The overall logistics services performance index of Turkey is not significantly different in comparison to upper middle-income group.

Table 6.51 Descriptive statistics of hypothesis H7b.

Size	Missing	Mean	Std.Dev.	Std.Error	C.I. of Mean
34	0	2.791	0.384	0.0659	0.134
Range	Max.	Min.	Median	25%	75%
1.440	3.460	2.020	2.785	2.530	3.090
Skewness	Kurtosis	K-S Dist.	K-S Prob.	SWilk W.	SWilk Prob.
-0.0668	-0.548	0.0968	0.536	0.975	0.607

Table 6.52 One sample t-test of hypothesis H7b.

Normality Test:		Passed (P = 0.607)		
N	Missing	Mean	Std.Dev.	SEM
34	0	2.791	0.384	0.0659

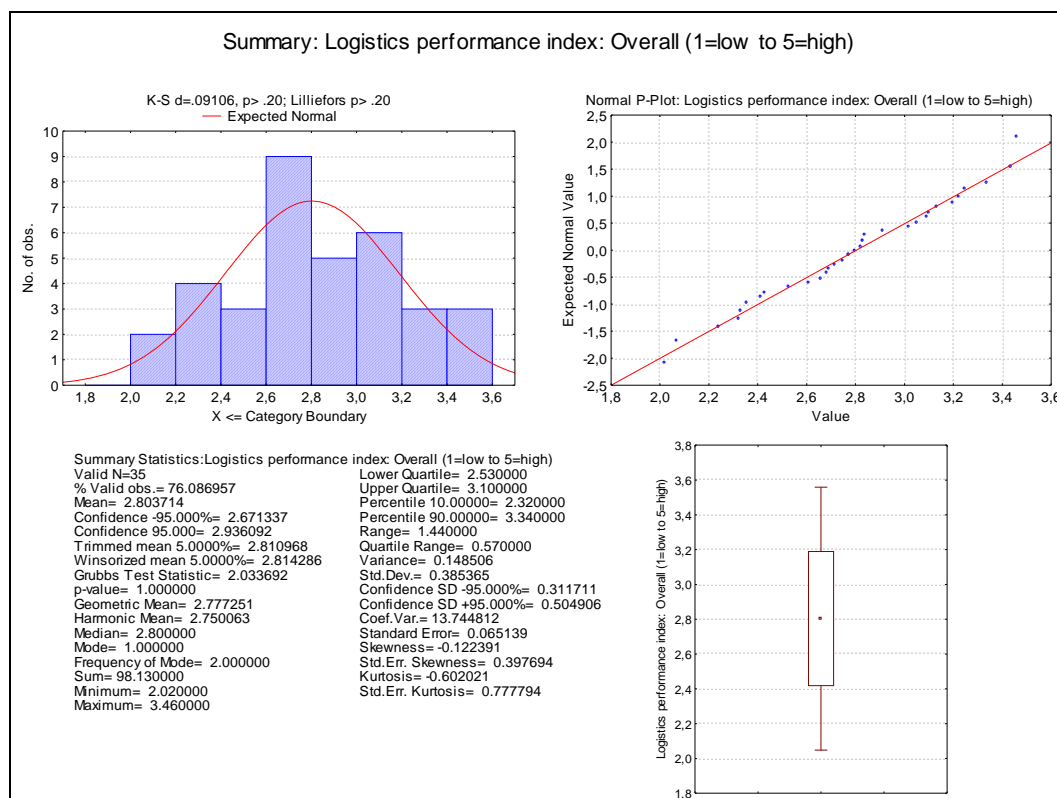

Figure 6.26 Descriptive statistics of the data

Hypothesized population mean is 3.220 and $t = -6.504$ with 33 degrees of freedom ($P = <0.001$). 95 percent confidence interval for the population mean: 2.657 to 2.926 and the power of performed test with $\alpha = 0.050$: 1.000 (See the figure and tables above).

There is a statistically significant difference between the mean of the sampled population and the hypothesized population mean ($P = <0.001$). Therefore, it is safe to reject the null hypothesis and accept the alternative hypothesis. H7b is rejected.

H7c: The overall logistics services performance index of Turkey differs in a negative and a significant manner in comparison to high-income OECD countries.

Table 6.53 Descriptive statistics of hypothesis H7c.

Size	Missing	Mean	Std.Dev.	Std.Error	C.I. of Mean
27	0	3.726	0.323	0.0622	0.128
Range	Max.	Min.	Median	25%	75%
1.150	4.110	2.960	3.850	3.633	3.947
Skewness	Kurtosis	K-S Dist.	K-S Prob.	SWilk W.	SWilk Prob.
-1.161	0.472	0.231	<0.001	0.863	0.002

Table 6.54 One sample t-test of hypothesis H7c.

Normality Test:		Failed (P < 0.050)			
N	Missing	Mean	Std.Dev.	SEM	
27	0	3.726	0.323	0.0622	

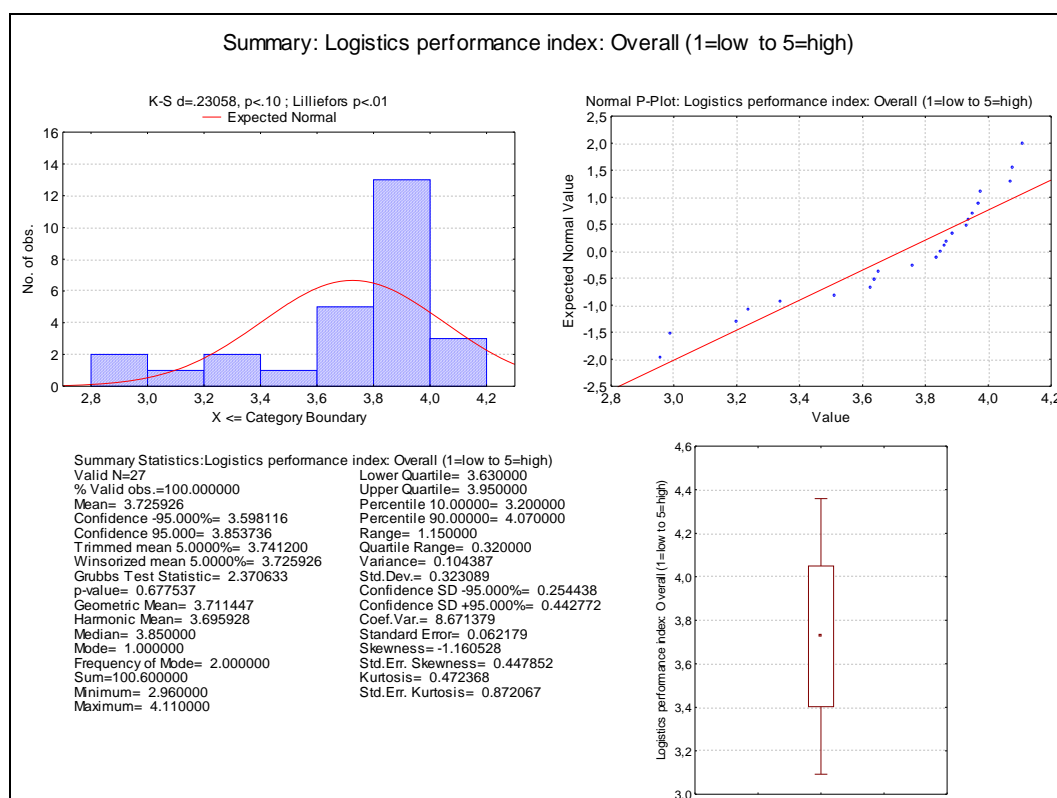

Figure 6.27 Descriptive statistics of the data

Hypothesized population mean is 3.220 and $t = 8.137$ with 26 degrees of freedom ($P = <0.001$). 95 percent confidence interval for the population mean: 3.598 to 3.854 and the power of performed test with $\alpha = 0.050$: 1.000 (See the figure and tables above)

There is a statistically significant difference between the mean of the sampled population and the hypothesized population mean ($P = <0.001$). Therefore, it is safe to accept the null hypothesis. H7c is supported.

H7d: The overall logistics services performance index of Turkey differs in a negative and a significant manner in comparison to high-income non-OECD countries.

Table 6.55 Descriptive statistics of hypothesis H7d.

Size	Missing	Mean	Std.Dev.	Std.Error	C.I. of Mean
15	0	3.211	0.410	0.106	0.227
Range	Max.	Min.	Median	25%	75%
1.340	4.090	2.750	3.160	2.847	3.400
Skewness	Kurtosis	K-S Dist.	K-S Prob.	SWilk W.	SWilk Prob.
0.847	0.00409	0.138	0.560	0.913	0.151

Table 6.56 One sample t-test of hypothesis H7d.

Normality Test:		Passed (P = 0.151)			
N	Missing	Mean	Std.Dev.	SEM	
15	0	3.211	0.410	0.106	

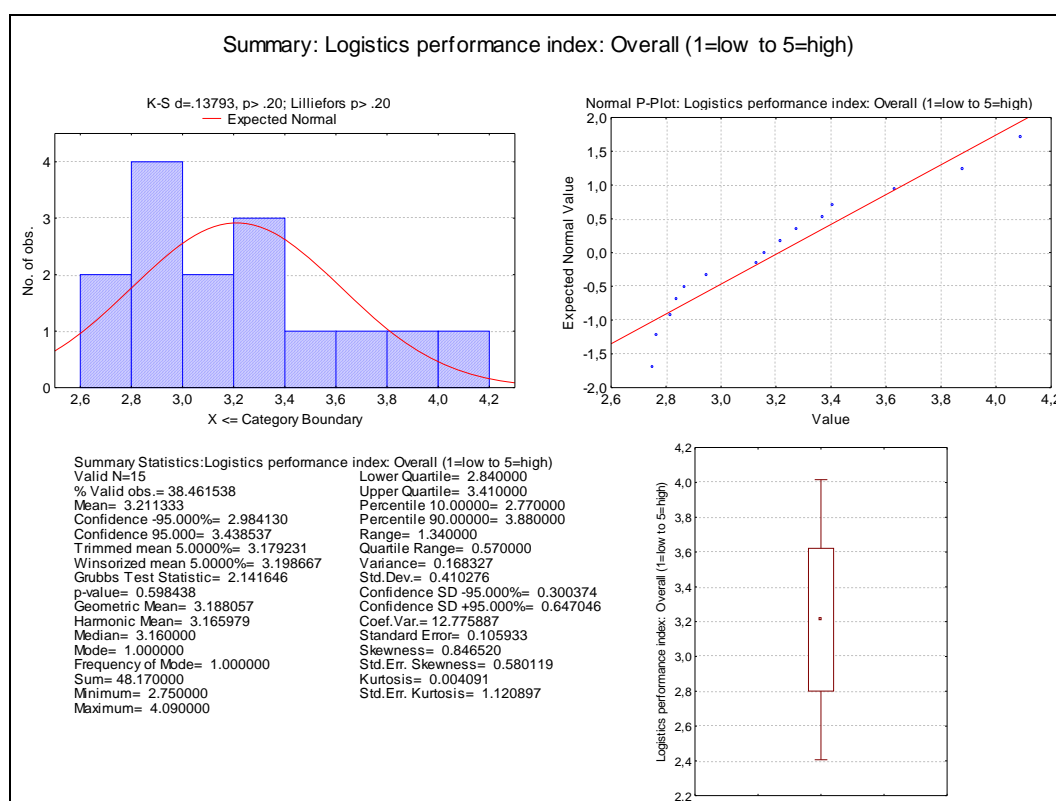

Figure 6.28 Descriptive statistics of the data

Hypothesized population mean is 3.220 and $t = -0.0818$ with 14 degrees of freedom ($P = 0.936$). 95 percent confidence interval for the population mean: 2.984 to 3.439 and the power of performed test with $\alpha = 0.050$: 0.051 (See the figure and tables above).

The power of the performed test (0.051) is below the desired power of 0.800. Less than desired power indicates it is less likely to detect a difference when one actually exists. Negative results should be interpreted cautiously.

The difference between the mean of the sampled population and the hypothesized population mean is not great enough to reject the hypothesis that the difference is only due to random sample variability. There is not a significant difference between the two means ($P = 0.936$). Therefore, it is safe to reject the null hypothesis. The overall logistics services performance index of Turkey differs in a negative but not in a significant manner in comparison to high-income non-OECD countries. H7d is rejected.

6.3 Hypotheses Results

Results reflect the most recent situation (available data: year 2009) of Turkey's logistics performance and also the indicators of seaport terminals' performance which have major and direct contributions to the overall/bulk logistics activities. (See table below.)

Table 6.57 All hypotheses and test results

Hypotheses	Status
H1b: The ability to track and trace consignments of logistics services in Turkey has no significant difference in comparison to upper middle-income group.	Rejected
H1d: The ability to track and trace consignments of logistics services in Turkey differs in a negative and a significant manner in comparison to high-income non-OECD countries.	Rejected
H2b: The competence and quality of logistics services in Turkey has no significant difference in comparison to upper middle-income group.	Rejected
H2d: The competence and quality of logistics services in Turkey differs in a negative and a significant manner in comparison to high-income non-OECD countries.	Rejected
H3b: The ease of arranging competitively priced shipments of logistics services in Turkey has no significant difference in comparison to upper middle-income group.	Rejected
H3d: The ease of arranging competitively priced shipments of logistics services in Turkey differs in a negative and a significant manner in comparison to high-income non-OECD countries.	Rejected
H4b: The efficiency of customs clearance process of logistics services in Turkey has no significant difference in comparison to upper middle-income group.	Rejected
H4d: The efficiency of customs clearance process of logistics services in Turkey differs in a negative and a significant manner in comparison to high-income non-OECD countries.	Rejected
H5b: The frequency with which shipments reach consignee within scheduled or expected time in Turkey has no significant difference in comparison to upper middle-income group.	Rejected
H5d: The frequency with which shipments reach consignee within scheduled or expected time in Turkey differs in a negative and a significant manner in comparison to high-income non-OECD countries.	Rejected

Table 6.57 All hypotheses and test results (Continued)

Hypotheses (Continued)	Status(Cont.'d)
H6b: The quality of trade and transport-related infrastructure in Turkey has no significant difference in comparison to upper middle-income group.	Rejected
H6d: The quality of trade and transport-related infrastructure in Turkey differs in a negative and a significant manner in comparison to high-income non-OECD countries.	Rejected
H7b: The overall logistics services performance index of Turkey is not significantly different in comparison to upper middle-income group.	Rejected
H7d: The overall logistics services performance index of Turkey differs in a negative and a significant manner in comparison to high-income non-OECD countries.	Rejected
H1a: The ability to track and trace consignments of logistics services in Turkey differs in a positive and a significant manner in comparison to lower middle-income countries.	Supported/Accepted
H1c: The ability to track and trace consignments of logistics services in Turkey differs in a negative and a significant manner in comparison to high-income OECD countries.	Supported/Accepted
H2a: The competence and quality of logistics services in Turkey differs in a positive and a significant manner in comparison to lower middle-income countries.	Supported/Accepted
H2c: The competence and quality of logistics services in Turkey differs in a negative and a significant manner in comparison to high-income OECD countries.	Supported/Accepted
H3a: The ease of arranging competitively priced shipments of logistics services in Turkey differs in a positive and a significant manner in comparison to lower middle-income countries.	Supported/Accepted
H3c: The ease of arranging competitively priced shipments of logistics services in Turkey differs in a negative and a significant manner in comparison to high-income OECD countries.	Supported/Accepted
H4a: The efficiency of customs clearance process of logistics services in Turkey differs in a positive and a significant manner in comparison to lower middle-income countries.	Supported/Accepted
H4c: The efficiency of customs clearance process of logistics services in Turkey differs in a negative and a significant manner in comparison to high-income OECD countries.	Supported/Accepted
H5a: The frequency with which shipments reach consignee within scheduled or expected time in Turkey differs in a positive and a significant manner in comparison to lower middle-income countries.	Supported/Accepted
H5c: The frequency with which shipments reach consignee within scheduled or expected time in Turkey differs in a negative and a significant manner in comparison to high-income OECD countries.	Supported/Accepted
H6a: The quality of trade and transport-related infrastructure in Turkey differs in a positive and a significant manner in comparison to lower middle-income countries.	Supported/Accepted
H6c: The quality of trade and transport-related infrastructure in Turkey differs in a negative and a significant manner in comparison to high-income OECD countries.	Supported/Accepted
H7a: The overall logistics services performance index of Turkey differs in a positive and a significant manner in comparison to lower middle-income countries.	Supported/Accepted
H7c: The overall logistics services performance index of Turkey differs in a negative and a significant manner in comparison to high-income OECD countries.	Supported/Accepted

Next chapter concludes the study, presents concluding remarks, and discussions along with some futuristic outlook for seaport logistic terminals.

CHAPTER SEVEN

CONCLUSIONS AND DISCUSSIONS

In this research, several methodologies for establishing and evaluating seaport operational activities at several levels are presented. This study provides several contributions to the body of knowledge in the field of seaport logistics operations and can assist managers and engineers in the design and improvement of seaport services.

From the beginning of the introductory part of this study, the brief motivation and the reason for a research on seaport logistic terminals were presented. It is also stated with some detail that world maritime fleet currently has a great potential of growth for the next coming years and thus the demand for superior terminal operations and handling facilities are high in a globally competitive environment of logistic terminals. Therefore, it is emphasized with some particular detail that the intense container traffic along with the harsh competitive environment puts the effective and efficient terminal service management at the most important priorities list of terminal service operators. A comprehensive literature review about the main seaport terminal operations with optimization and heuristic methods were presented along with key references from the literature. Optimization issues and fundamental seaport terminal operation models were introduced and operational models are grouped. Then, pure base mathematical models of scheduling quay cranes, yard cranes, workforce, trailer/vehicle routing, layout of sheltering, storage, and warehousing operations introduced. Additionally, fundamental problems of optimization, which are as well applicable to seaport terminals were briefly described and presented. Innovative methods, techniques, and algorithms were presented to solve complex optimization problems of logistics terminals. Key operational models were solved with innovative methods, algorithms and solution histories were presented with some particular details. In addition to the problem solutions, key terminal equipment characteristic of quay crane and major operational simulations and optimum resource assignment strategies of seaport terminal operations were presented. Comprehensive solutions to the key operational problems were achieved and forefront methodologies and algorithms utilized to solve complex operational problems. Numerous complex

combinatorial optimization problems and assignment problems solved by utilizing the methods, algorithm, and/or technique presented. Experimental results proved that the introduced methods are applicable to the solution of various operational problems. Essential problems of container terminals stated, and solutions to these problems were investigated by utilizing innovative techniques, algorithms, and methodologies. Results indicate that proposed concepts for container terminals-IT systems have a positive and direct effect on the service level efficiency. Furthermore, several hypotheses developed, analyzed and tested. These testing were done by using the statistical “t-test” technique. Various hypothesized population mean tested across several incomes groups, countries group; namely, lower middle income countries, upper middle income countries, high income countries that are member of OECD and high income countries that are not member of OECD. Hypotheses results reveal important hints about the current state of Turkey’s logistics performance index and an opinion and a reflection of logistic terminals.

There is a wide variety of technical equipment, layouts, facilities, resources, and proficient workers at seaport terminals. The amount of resources used at seaport terminals adds a multitude of complexities to dynamic optimization problems. Therefore, in such dynamic environments there is a need to solve complex operational problems in order to increase terminal service efficiency and improve competitiveness. Based on the number and complexity of seaport processes, obtaining optimal solutions by using heuristic methods are a NP-hard problem, and computational time exponentially increases depending on the amount of resources involved in the problem. In particular, the CE algorithm’s approach provides stable solutions by discovering optimal values. By running the proposed high performing CE algorithm for the problems of seaport terminals, it is apparent that there could be significant improvements in seaport terminal services.

7.1 About Findings

First contribution of thesis is that it provides up-to-date literature background, about not only the current state-of-the-art methods, techniques and applications, but

also provides background information about logistics systems' industrial positioning and the outlook of the sector.

Second contribution is about the models of specific operational seaport problems. Innovative and high performing optimization methods and algorithms are brought into the scene. The problems are exemplified and the proposed methods are utilized to achieve optimal and the best possible solution. Thus, the generated solutions along with the methods have the highest potential to be applied into the real world scenarios by making the necessary modifications and adaptations.

Third contribution of this study is that it enhances the research about the seaport logistics terminals and allows for the development of further research questions in this area. In addition, the applicability of this research in real-world cases is high and the knowledge gained from this study will have a direct impact on the field.

Container terminals are important assets of all countries in the world, as they are the essential import/export trade gates. Thus, the competition among the container terminals are tough around the world. High volume terminals, such as Rotterdam, Singapore, Hong Kong, etc take seriously the issue of logistics excellence at their terminals and make huge investments to achieve further efficiency on port service levels. Although this thesis takes the case of Izmir seaport of logistics terminal, provided techniques, methods, algorithms in the context of the thesis is applicable to every container operations. For instance, Izmir seaport of logistics terminal is not a fully automated container terminal. The terminal has no applications of unmanned terminal vehicles, such as AGVs, ALVs, SCs, etc. On the other hand, the terminal is well equipped to handle all types of containers and cargos with its 24 berths for cargo handling facilities.

7.2 Future Outlook and Discussion

The globalization of trade has significant effect on container shipping worldwide. The significant increase in demand of container shipping and the competition among

the container terminals have created a demand for new ways of container terminal operations. One of the possible ways of improvement at container terminal is the monitoring of terminal equipments. The ubiquitous sensor network (USN) is one of the enabling technologies that can be used at container terminals. Although it is a new technology for container terminal operations, it has number of successful applications in other areas; industrial control, manufacturing, medical and environmental monitoring and so on. Briefly, the USN is mainly about the utilization of radio frequency identification system (RFID), global positioning system (GPS) or Wi-Fi, smart tags, etc. With these technologies, it becomes possible to follow movements of terminal equipments and thus it becomes possible to improve operations instantly by monitoring inefficient operations at the terminal.

Further research ought to be conducted to investigate optimal operational activity under the uncertainty of fully automated container terminals that are utilizing only unmanned terminal vehicles and using automatic stacking (AS) and retrieval systems (RS) for container storage. The current limitation associated with the use of AGVs, for instance, is that they are slower than the manned terminal vehicles and thus have, to some degree, an adverse effect on terminal efficiency. The future unmanned terminal equipment will have superior properties and the trend seems to be going towards completely unmanned container terminal operations. For example, the container terminal at Brisbane, Australia, successfully uses unmanned straddle carriers for handling and stacking containers in the yard-area operations and the system relies on the location information retrieved from global position system (GPS) and radio waves propagated throughout the container terminal area. Such systems reduce the total cost of running a container terminal and the risks and hazards associated with human factors. Additionally, such unmanned systems are suitable for terminals where the cost of employment is high. Thus, these systems are helping to balance port competitiveness that is caused by higher costs of employments.

On the other hand, ship designers are making futuristic vessel designs. For instance, these design concepts eliminate long-lasting container-handling operations

by QCs at the berth area. Such conceptual vessels are designed to discharge and load all of the containers by utilizing a shifting pallet system that does not require handling equipment such as cranes in the berthing area. However, this concept has some obstacles that prevent it from becoming a reality because the current vessel manufacturing technology does not allow such designs to be applied. Further, no container terminal around the world is able to handle a huge volume of cargo at one time.

REFERENCES

- Aarts, E. & Korst, J. (1989). *Simulated Annealing and Boltzmann Machines*. John Wiley & Sons.
- Abdulaal, M. & Le Blanc, L. (1979). Continuous equilibrium network design models, *Transportation Research Part B*, 13, pp. 19–32.
- Baaj, H. & Mahmassani, H.S. (1992). TRUST: a lisp program for the analysis of transit route configurations, *Transportation Research Record* 1283, pp. 125–135.
- Baaj, H. & Mahmassani, H.S. (1995). Hybrid route generation heuristic algorithm for the design of transit networks, *Transportation Research Part C*, 3, pp. 31–50.
- Bae, H.Y., et al. (2009). Comparison of operations of AGVs and ALVs in an automated container terminal, *Journal of Intelligent Manufacturing*
- Beltran, B., et al, (2009). Transit network design with allocation of green vehicles: A genetic algorithm approach, *Transportation Research Part C: Emerging Technologies*, Volume 17, Issue 5, Artificial Intelligence in Transportation Analysis: Approaches, Methods, and Applications, pp. 475-483
- Bierwirth, C. & Meisel, F. (2009). A fast heuristic for quay crane scheduling with interference constraints. *Journal of Scheduling*.
- Bielli, M., et al. (2006). Object oriented model for container terminal distributed simulation, *European Journal of Operational Research*, Volume 175, Issue 3, 16, pp. 1731-1751

- Billheimer, J.W. & Gray, P. (1973). Network design with fixed and variable cost elements, *Transportation Science*, 7, pp. 49–74.
- Bish, E. K., Leong, T. Y., Li, C. L., Ng, W. C. & Simchi-Levi D. (2001). Analysis of a new vehicle scheduling and location problem. *Naval Research Logistics*, pp. 363–385.
- Boyce, D.E. & Janson, B.N. (1980). A discrete transportation network design problem with combined trip distribution and assignment, *Transportation Research Part B*, 14, pp. 147–154.
- Brinkmann, B. (2005) *Seaports – planning and design* (in German). Springer, Berlin
- Cantarella, G.E. & Vitetta, A. (2006). The multi-criteria road network design problem in an urban area, *Transportation*, 33, pp. 567–588.
- Cantarella, G.E., et al. (2006). Heuristics for urban road network design: Lane layout and signal settings, *European Journal of Operational Research*, 175, pp. 1682–1695.
- Caramia, M. & Dell’Olmo, P. (2008). Multi-objective Management in Freight Logistics, *Maritime Freight Logistics*, pp. 37-64
- Carrese, S. & Gori, S. (2002). An urban bus network design procedure. In: Patriksson, M., Labbè, M., (Eds.), *Transportation Planning: State of the Art*, pp. 177–196.
- Ceder, A. & Israeli, Y. (1993). Design and evaluation of transit routes in urban networks. In: *Proceedings of the 3rd International Conference on Competition and Ownership in Surface Passenger Transport*, Ontario, Canada.

- Chen, M. and Alfa, A.S. (1991). A network design algorithm using a stochastic incremental traffic assignment approach, *Transportation Science* 25, pp. 215–224.
- Chen, L., et al. (2007). A tabu search algorithm for the integrated scheduling problem of container handling systems in a maritime terminal, *European Journal of Operational Research*, pp. 40–58.
- Cheung, R.K., et al. (2002). Interblock crane deployment in container terminals. *Transportation Science*, pp. 79–83.
- Chiou, S.W. (2005). Bilevel programming for the continuous transport network design problem, *Transportation Research Part B*, 39, pp. 361–383.
- Cho, H.J. & Lo, S.C. (1999). Solving bilevel network design problem using linear reaction function without nondegeneracy assumption, *Transportation Research Record*, 1667, pp. 96–106.
- Christiansen, M., et al. (2007). Chapter 4 Maritime Transportation, In: Cynthia Barnhart and Gilbert Laporte, Editor(s), *Handbooks in Operations Research and Management Science*, Elsevier, Volume 14, *Transportation*, pp. 189-284
- Claudio, B. C. & Silva, M.R. (2007). A genetic algorithm for the problem of configuring a hub-and-spoke network for a LTL trucking company in Brazil, *European Journal of Operational Research*, Volume 179, Issue 3, 16, pp. 747-758
- Colomi, A., et al. (1996). Heuristics from nature for hard combinatorial problems. *International Transactions in Operational Research*, pp. 1-21

- Connor, J. D. (2008). *Antenna array synthesis using the cross entropy method*, Ph.D. Thesis, The Florida State University
- Crainic, T.G. & Kim, K.H. (2007). Chapter 8 Intermodal Transportation, In: Cynthia Barnhart and Gilbert Laporte, Editor(s), *Handbooks in Operations Research and Management Science*, Elsevier, 2007, Volume 14, *Transportation*, pp. 467-537
- Cruz, F.R.B., et al. (1999). Algorithms for a multi-level network optimization problem, *European Journal of Operational Research*, 118, pp. 164–180.
- Dantzig, G.B., et al. (1979). Formulating and solving the network design problem by decomposition, *Transportation Research Part B*, 13, pp. 5–17.
- Davis, G.A. (1994). Exact local solution of the continuous network design problem via stochastic user equilibrium assignment, *Transportation Research Part B*, 28, pp. 61–75.
- Dhingra, S.L., et al. (2000). Public transport routing and scheduling using genetic algorithms. In: *Proceedings Presented at the CASPT 8th International Conference*, Berlin, Germany.
- Dorigo, M., et al. (1999). Ant algorithms for discrete optimization. *Artificial life*, pp. 137-172
- Dowd, T.J. & Leschine, T.M. (1990). Container terminal productivity: A perspective, *Maritime Policy and Management* 17 (2), pp. 107–112.
- Drezner, Z. & Wesolowsky, G.O. (2003). Network design: Selection and design of links and facility location, *Transportation Research Part A*, 37, pp. 241–256.

- Ehrgott, M. & Gandibleux, X. (eds.) (2002). *Multiple Criteria Optimization: State of the Art Annotated Bibliographic Surveys*. Secaucus, NJ, USA: Kluwer Academic Publishers.
- Foulds, R.L. (1981). A multicommodity flow network design problem, *Transportation Research Part B*, 15, pp. 273–283.
- Friesz, T.L., et al. (1992). A simulated annealing approach to the network design problem with variational inequality constraints, *Transportation Science*, 26, pp. 18–26.
- Froyland, G., et al. (2008). Optimizing the landside operation of a container terminal, *OR Spectrum* Volume 30, Issue 1, pp. 53-75, 2008
- Gallo, M., et al. (2010). A meta-heuristic approach for solving the Urban Network Design Problem, *European Journal of Operational Research*, Volume 201, Issue 1, 16, pp. 144-157
- Gambardella, L.M., et al. (2001). An optimization methodology for intermodal terminal management, *Journal of Intelligent Manufacturing*, pp. 521–534.
- Gao, Z., et al. (2005). Solution algorithm for the bi-level discrete network design problem, *Transportation Research Part B*, 39, pp. 479–495.
- Garey, M.R. & Johnson, D.S. (1979). *Computer and Intractability*, Freeman, San Fransico, CA.
- GaWC: Globalisation and World Cities, (2005). *GaWC: Globalisation and World Cities*, 23, Inventory of World Cities.

- Goldberg, D. (1989). *Genetic Algorithms in Search, Optimization and Machine Learning*. Addison Wesley.
- Goodchild, A. & Daganzo, C. (2007). Crane double cycling in container ports: planning methods and evaluation, *Transportation Research Part B*, pp. 875–891.
- Harker, T.P., & Friesz, T.L. (1984). Bounding the solution of the continuous equilibrium network design problem. In: Volmuller, J., Hamerslag, R.(Eds.), *Proceedings of 9th International Symposium on Transportation and Traffic Theory*. VNU Science Press, Utrecht, The Netherlands, pp. 233–252.
- Herrmann, J.W., et al. (1996). A dual ascent approach to the fixed-charge capacitated network design problem, *European Journal of Operational Research*, 95, pp. 476–490.
- Hesse, M. (2008). *City as a Terminal : The Urban Context of Logistics and Freight Transport*. Abingdon, Oxon, , GBR: Ashgate Publishing, Limited, p 18.
- Kalmar Industries (2009). *Products*. <http://www.kalmarind.com/show.php?id=605>
- Kim, K.H., et al. (2006). Deadlock prevention for automated guided vehicles in automated container terminals, *OR Spectrum*, Volume 28, Issue 4, pp. 659-679
- Kim, K.H. & Bae, J.W. (1998). Re-marshaling export containers in port container terminals. *Computers & Industrial Engineering*, pp. 655–658.
- Kim, K.H. & Kim, H.B. (1998). The optimal determination of the space requirement and the number of transfer cranes for import containers. *Computers & Industrial Engineering*, pp. 427–430.

- Kim, K.H. & Park, Y-M. (2004). A crane scheduling method for port container terminals, *European Journal of Operational Research*, pp. 752–768.
- Kim, K.H. et al. (2004). A beam search algorithm for the load sequencing of outbound containers in port container terminals, *OR Spectrum*, pp. 93–116.
- Kim, K.H. (2005). Models and methods for operations in port container terminals. In: Langevin, A., Riopel, D. (Eds.), *Logistics systems: design and optimization*. Gerad 25th Anniversary Series. Springer, Berlin et al., pp. 213–243.
- Kozan, E. & Preston, P. (1999). Genetic algorithms to schedule container transfers at multimodal terminals. *International Transactions in Operational Research*, pp. 311–329.
- Le Blanc, L.J. & Boyce, D.E. (1986). A bilevel programming algorithm for exact solution of the network design problem with user optimal flows, *Transportation Research Part B*, 20, pp. 259–265.
- Le Blanc, L.J. (1975). An algorithm for the discrete network design problem, *Transportation Science*, 9, pp. 183–199.
- Lee, Y. & Chen, Y-C. (2008). An optimization heuristic for the berth scheduling problem, *European Journal of Operational Research*, pp. 500–508.
- Lee, Y.H., et al. (2005). Optimization of container load sequencing by a hybrid of ant colony optimization and tabu search, *Lecture Notes in Computer Science*, pp. 1259–1268.
- Lee, D.H., et al. (2008a). Quay crane scheduling with non-interference constraints in port container terminals, *Transportation Research Part E*, pp. 124–135.

- Lee, H.Q., et al. (2008b). Quay crane scheduling with handling priority in port container terminals, *Engineering Optimization*, pp. 179–189.
- Legato, P. & Mazza, R.M. (2001). Berth planning and resources optimisation at a container terminal via discrete event simulation, *European Journal of Operational Research*, pp. 537–547.
- Li, C.L., et al. (1998). Scheduling with multiple-job-on-one-processor pattern, *IIE Transactions*, pp. 433–445.
- Liang, C., et al. (2008). A quay crane dynamic scheduling problem by hybrid evolutionary algorithm for berth allocation planning, *Computers and Industrial Engineering*, pp. 1021–1028.
- Lim, A., et al. (2002). Crane scheduling using tabu search. In: Proceedings of the 14th *IEEE International Conference on Tools with Artificial Intelligence (ICTAI'02)*. IEEE Computer Society, Washington DC, pp. 146–153.
- Lim, A., et al. (2004a). Crane scheduling with spatial constraints, *Naval Research Logistics*, pp. 386–406.
- Lim, A., et al. (2007). A m-parallel crane scheduling problem with a non-crossing constraint, *Naval Research Logistics*, pp. 115–127.
- Liu, C-I., et al. (2002). Design, simulation, and evaluation of automated container terminals. *IEEE Transactions on Intelligent Transportation Systems*, pp. 12–26.
- Liu, J., et al. (2006). Quay crane scheduling at container terminals to minimize the maximum relative tardiness of vessel departures, *Naval Research Logistics*, pp. 60–74.

- Lokuge, P. & Alahakoon, D. (2004). Hybrid BDI agents with improved learning capabilities for adaptive planning in a container terminal application. In: *Proceedings of the International Conference on Intelligent Agent Technology (IAT'04)*. IEEE Computer Society, Los Alamitos, pp. 120–126.
- Lokuge, P. & Alahakoon, D. (2007). Improving the adaptability in automated vessel scheduling in container ports using intelligent software agents, *European Journal of Operational Research*, pp. 1985–2015.
- Los, M. and Lardinois, C. (1982). Combinatorial programming, statistical optimization and the optimal transportation network problem, *Transportation Research Part B*, 16, pp. 89–124.
- Los, M. (1979). A discrete-convex programming approach to the simultaneous optimization of land use and transportation, *Transportation Research Part B*, 13, pp. 33–48.
- Mansell, J.N.K. (2009). *Flag State Responsibility, The Changing World Map of Flag States*, pp. 71-89
- Meisel, F. (2009). Seaside Operations Planning in Container Terminals, *Maritime Container Transport*, pp. 5-15
- Meng, Q & Yang, H. (2002). Benefit distribution and equity in road network design, *Transportation Research Part B*, 36, pp. 19–35.
- Meng, Q., et al. (2001). An equivalent continuously differentiable model and a locally convergent algorithm for the continuous network design problem, *Transportation Research Part B*, 35, pp. 83–105.

- Murty, K.G., et al. (2005). A decision support system for operations in a container terminal, *Decision Support Systems*, Volume 39, Issue 3, pp. 309-332
- Newell, G.F. (1979). Some issue relating to the optimal design of bus lines, *Transportation Science*, 13 (1), pp. 20–35.
- Ngamchai, S. & Lovell, D.J. (2003). Optimal time transfer in bus transit route network design using a genetic algorithm, *Journal of Transportation Engineering*, 129 (5), pp. 510–521.
- Notteboom, T. & Rodrigue, J-P. (2009). The future of containerization: perspectives from maritime and inland freight distribution, *GeoJournal* Volume 74, Issue 1, pp. 7-22.
- Pardalos, P.M. (Ed). (2002). *Combinatorial and Global Optimization*. River Edge, NJ, USA: World Scientific, p 100.
- Pattnaik, S.B., et al. (1998). Urban bus transit network design using genetic algorithm, *Journal of Transportation Engineering*, 124 (4), pp. 368–375.
- Peterkofsky, R.I. & Daganzo, C.F. (1990). A branch and bound solution method for the crane scheduling problem. *Transportation Research-B*, pp. 159–172.
- Pinedo, M. (2002). *Scheduling – Theory Algorithms and Systems (2nd ed.)*, Prentice-Hall, Englewood Cliffs, NJ.
- Poorzahedy, H. & Abulghasemi, F. (2005). Application of ant system to network design problem, *Transportation*, 32, pp. 251–273.

- Poorzahedy, H. & Rouhani, O.M. (2007). Hybrid meta-heuristic algorithms for solving network design problem, *European Journal of Operational Research*, 182, pp. 578–596.
- Poorzahedy, H. & Turnquist, M.A. (1982). Approximate algorithms for the discrete network design problem, *Transportation Research Part B*, 16, pp. 45–55.
- Port of Hamburg Marketing (2008). *Port of Hamburg: statistics*. Hamburg,
- Port of Hamburg Marketing/D Hasenpusch (2008). *Port of Hamburg: photos for press*.
- Rashidi, H. (2006). *Dynamic scheduling of automated guided vehicles*. Ph.D. Thesis, University of Essex, Colchester.
- Reeves, C.R. (2002). *Genetic Algorithms - Principles and Perspectives : A Guide to GA Theory*. Secaucus, NJ, USA: Kluwer Academic Publishers, p1.
- Rubinstein, R.Y. & Kroese, D.Y. (2004). The Cross-Entropy Method: A Unified Approach to Combinatorial Optimization, *Monte-Carlo Simulation and Machine Learning*. Springer-Verlag, New York.
- Rubinstein, R.Y. & Melamed, B. (1998). *Modern simulation and modeling*. Wiley series in probability and Statistics.
- Rubinstein, R.Y. & Shapiro, A. (1993). *Discrete Event Systems: Sensitivity Analysis and Stochastic Optimization via the score function method*. Wiley.
- Rubinstein, R.Y. (1997). Optimization of computer simulation models with rare events. *European Journal of Operations Research*, pp. 89-112.

- Rubinstein, R.Y. (1999). The cross-entropy method for combinatorial and continuous optimization. *Methodology and Computing in Applied Probability*, pp. 127-190.
- Rubinstein, R.Y. (2001). Combinatorial optimization, cross-entropy, ants and rare events. In S. Uryasev and P. M. Pardalos, editors, *Stochastic Optimization: Algorithms and Applications*, Kluwer, pp. 304-358.
- Russo, F. & Vitetta, A. (2006). A topological method to choose optimal solutions after solving the multi-criteria urban network design problem, *Transportation*, 33, pp. 347–370.
- Sarker, R., et al. (2008). *Optimization Modelling: a practical approach*. CRC Press
- Sarker, R. (Ed.). (2002). *Evolutionary Optimization*. Secaucus, NJ, USA: Kluwer Academic Publishers, p 29.
- Sergienko, I.V., et al. (2009). Classification of applied methods of combinatorial optimization. *Cybernetics and Systems Analysis*, V.45, N.5
- Sharma, M.J. & Yu, S.J. (2009). Performance based stratification and clustering for benchmarking of container terminals, *Expert Systems with Applications*, Volume 36, Issue 3, Part 1, pp. 5016-5022
- Sivanandam, S.N. & Deepa S.N., (2008). *Introduction to Genetic Algorithms, Terminologies and Operators of GA*, Springer, pp. 39-81.
- Solanki, R.S., et al. (1998). The highway network design problem, *Transportation Research Part B*, 32, pp. 127–140.
- Stahlbock, R. & Voß, S. (2008). Operations research at container terminals: a literature update, *OR Spectrum*, pp. 1–52.

- Steenken, D., Vob S., & Stahlbock R. (2007). *Container Terminals and Automated Transport Systems*, Container terminal operation and operations research – a classification and literature review.
- Steenken, D., et al. (2004). Container terminal operation and operations research – a classification and literature review, *OR Spectrum*, pp. 3–49.
- Soppe, M., et al. (2009). Emerging inter-industry partnerships between shipping lines and stevedores: from rivalry to cooperation?, *Journal of Transport Geography*, Volume 17, Issue 1, pp. 10-20.
- Suwansirikul, T.L., et al. (1987). Equilibrium decomposed optimization: A heuristic for the continuous equilibrium network design problem, *Transportation Science*, 21, pp. 254–263.
- Taleb-Ibrahimi, M., et al. (1993). Storage space vs. handling work in container terminals. *Transportation Research. Part: B Methodological*, pp. 13–32.
- Tavakkoli-Moghaddam, R., et al. (2009). An efficient algorithm for solving a new mathematical model for a quay crane scheduling problem in container ports, *Computers and Industrial Engineering*, pp. 241–248.
- Ukkusuri, S.V., et al. (2007). Robust transportation network design under demand uncertainty, *Computer-Aided Civil and Infrastructure Engineering*, 22, pp. 6–18.
- UNCTAD, (2003) *UNCTAD, Review of Maritime Transport*, United Nations, New York and Geneva.
- UNCTAD, (2004) *UNCTAD, Review of Maritime Transport*, United Nations, New York and Geneva.

- Van Hee, K.M. & Wijbrands, R.J. (1998). Decision support system for container terminal planning. *European Journal of Operational Research*, pp. 262–272.
- Verhetsel, A. & Sel, S. (2009). World maritime cities: From which cities do container shipping companies make decisions?, *Transport Policy*, Volume 16, Issue 5, SI: TBGS, The International Forum on Shipping, Ports and Airports (IFSPA) 2008, pp. 240-250.
- Vis, I.F.A. & Van Anholt, R.G. (2010), Performance Analysis of Berth Configurations at Container Terminals, *OR Spektrum*, 32(3), pp. 453-476.
- Vis, I.F.A. & de Koster, R. (2003). Transshipment of containers at a container terminal: An overview, *European Journal of Operational Research*, Volume 147, Issue 1, pp. 1-16.
- Vis, I. & de Koster, R. (2003). Transshipment of containers at a container terminal: an overview. *European Journal of Operational Research*, pp. 1–16.
- WBCSD, (2002) *Mobility 2001: World Mobility at the End of the Twentieth Century, and its Sustainability*. World Business Council for Sustainability.
- WBCSD, (2004a) *Mobility 2030: Meeting the Challenges to Sustainability*. <<http://www.wbcsd.ch/>> accessed 30/05/07.
- WBCSD, (2004b) *IEA/SMP Model Documentation and Reference Projection*. Fulton, L. and G. Eads, <<http://www.wbcsd.org/web/publications/mobility/smp-model-document.pdf>> accessed 30/05/07
- Zhang, C., et al. (2002). Dynamic crane deployment in container storage yards. *Transportation Research. Part B: Methodological*, pp. 537–555.

Zhang, C., et al. (2003). Storage space allocation in container terminals. *Transportation Research. Part B: Methodological*, pp. 883–903.

Zhu, Y. & Lim, A. (2006). Crane scheduling with non-crossing constraint, *Journal of the Operational Research Society*, pp. 1464–1471.

APPENDIX A
MORE INFORMATION ABOUT CROSS ENTROPY (CE) METHOD

Maximization problem of $Z(x)$ can be represented by

$$Z(x^*) = \gamma^* = \max_{x \in X} Z(x)$$

The probability that the score function $Z(x)$ evaluated at a particular state x is close to γ^* is classified as a rare-event.

This probability can be determined from an associated stochastic problem (ASP),

$$P_v(Z(x) \geq \gamma) = E_v I_{\{Z(x) \geq \gamma\}} \quad (1)$$

where P_v is the probability measure that the score is greater than some value γ close to γ^* . x is the random variable produced by the pdf $f(\cdot, v)$, E_v is the expectation operator and $I_{\{\cdot\}}$ is a set of indices where $Z(x)$ is greater than or equal to γ .

Calculating the right hand side of (1) is a non-trivial problem that can be estimated using a log-likelihood estimator with parameter v ,

$$\hat{v}^* = \arg \max_v \frac{1}{N} \sum_{i=1}^{N_s} I_{\{Z(x_i) \geq \gamma\}} \ln f(x_i, v)$$

where x_i is generated from $f(\cdot, v)$ and N_s is the number of samples where $Z(x_i) > \gamma, N_s \leq K$.

As γ becomes close to γ^* , most of the probability mass is close to x^* and is an approximate solution to $Z(x^*) = \gamma^* = \max_{x \in X} Z(x)$.

One important requirement is that as γ becomes close to γ^* that $P_v(Z(x) \geq \gamma)$ is not too small, otherwise the algorithm will result in a suboptimal solution. So, there is a tradeoff between γ being arbitrarily close to γ^* while maintaining accuracy in the estimate of v .

The CE method efficiently solves this estimation problem by adaptively updating the estimate of the optimal density $f(\cdot, v^*)$, thus creating a sequence of pairs $\{\hat{\gamma}^{(t)}, \hat{v}^{(t)}\}$ at each iteration t in an iterative procedure, which converges quickly to an arbitrarily small neighborhood of the optimal pair $\{\gamma^*, v^*\}$.

General CE Optimization Algorithm

1. Initialize parameters: Set initial parameter $\hat{v}^{(0)}$, choose a small value ρ , set population size K , smoothing constant α and set iteration counter $t=1$
2. Update $\hat{\gamma}^{(t)}$:

Given $\hat{v}^{(t-1)}$, let $\hat{\gamma}^{(t)}$ be the $(1-\rho)$ -quantile of $Z(x)$ satisfying

$$\begin{aligned} P_{v^{(t-1)}}(Z(x) \geq \gamma^{(t)}) &\geq \rho \\ P_{v^{(t-1)}}(Z(x) \leq \gamma^{(t)}) &\geq 1 - \rho \end{aligned}$$

with x sampled from $f(\cdot, \hat{v}^{(t-1)})$.

Then, the estimate of $\gamma^{(t)}$ is calculated computed as

$$\hat{\gamma}^{(t)} = Z_{(\lceil (1-\rho)K \rceil)}$$

where $\lceil \cdot \rceil$ rounds $(1-\rho)K$ towards infinity.

3. Update $\hat{v}^{(t)}$:

Given $\hat{v}^{(t-1)}$, determine $\hat{v}^{(t)}$ by solving the CE program

$$\hat{v}^{(t)} = \max_v \frac{1}{N_s} \sum_{i=1}^{N_s} I_{\{Z(x_i) \geq \hat{\gamma}^{(t)}\}} \ln f(x_i, v) \quad (3)$$

4. Optional step: (Smooth update of $\hat{v}^{(t)}$)

To decrease the probability of the CE procedure converging too quickly to a suboptimal solution, a smoothed update of $\hat{v}^{(t)}$ can be computed.

$$\hat{v}^{(t)} = \alpha \hat{v}^{(t)} \cup^{(t)} + (1-\alpha) \hat{v}^{(t-1)}$$

where $\hat{v}^{(t)}$ is the estimate of the parameter vector computed with (3), $\hat{v}^{(t-1)}$ is the parameter estimate from the previous iteration and α (for $0 < \alpha \leq 1$) is a constant smoothing coefficient. By setting $\alpha = 1$, the update will not be smoothed.

5. Set $t=t+1$ and repeat steps 2 to 4 until the stopping criteria is satisfied.

Cross Entropy Method for Continuous Optimization

For Gaussian distribution represented by the pdf,

$$f(x, \eta) = \frac{1}{\sqrt{2\pi\sigma^2}} \exp\left(-\frac{1}{2} \frac{(x-\mu)^2}{\sigma^2}\right), \quad x \in \mathbb{R}, \quad \eta = (\mu, \sigma^2)$$

The estimate of the optimal CE update parameter for any distribution is solved using,

$$\hat{v}^{(t)} = \max_v \frac{1}{N_s} \sum_{i=1}^{N_s} I_{\{Z(x_i) \geq \hat{\gamma}^{(t)}\}} \ln f(x_i, v)$$

To solve for a Gaussian distribution, first shorthand notation is defined for the indices of the score samples, which exceed γ ,

$$I_{\{Z(x) \geq \gamma\}} = I_i$$

The expansion of the term $\ln(f(x, \eta))$,

$$\ln f(x, \eta) = \ln\left(\frac{1}{\sqrt{2\pi\sigma^2}} \exp\left(-\frac{1}{2} \frac{(x-\mu)^2}{\sigma^2}\right)\right)$$

Reminder: $\ln(ab) = \ln(a) + \ln(b)$

Thus,

$$\ln f(x, \eta) = \ln\left(\frac{1}{\sqrt{2\pi\sigma^2}}\right) + \ln\left(\exp\left(-\frac{1}{2} \frac{(x-\mu)^2}{\sigma^2}\right)\right)$$

Reminder: $\ln(1/a) = -\ln(a)$ and $\ln(e^b) = b$, where

$$a = \sqrt{2\pi\sigma^2} \text{ and } b = -(x_i - \mu)^2 / (2\sigma^2),$$

$$\ln f(x, \eta) = -\ln \sqrt{2\pi\sigma^2} - \frac{1}{2} \frac{(x_i - \mu)^2}{\sigma^2}$$

Reminder: $\ln(a^b) = b \ln(a)$, where $a = 2\pi\sigma^2$ and $b = 1/2$,

$$\ln f(x, \eta) = -\frac{1}{2} \ln(2\pi\sigma^2) - \frac{1}{2} \frac{(x_i - \mu)^2}{\sigma^2}$$

Reminder: $\ln(2\pi\sigma^2)$ is $\ln(ab) = \ln(a) + \ln(b)$, where $a = 2\pi$ and $b = \sigma^2$,

$$\ln f(x, \eta) = -\left(\frac{1}{2} \ln(2\pi) + \frac{1}{2} \ln(\sigma^2) + \frac{1}{2} \frac{(x_i - \mu)^2}{\sigma^2} \right)$$

Substituting this result into

$$\hat{v}^{(t)} = \max_v \frac{1}{N_s} \sum_{i=1}^{N_s} I_{\{Z(x_i \geq \hat{v}^{(t)})\}} \ln f(x_i, v)$$

yields

$$\hat{\eta} = \max_{\eta} \frac{1}{N_s} \sum_{i=1}^{N_s} I_i \left[-\left(\frac{1}{2} \ln(2\pi) + \frac{1}{2} \ln(\sigma^2) + \frac{1}{2} \frac{(x_i - \mu)^2}{\sigma^2} \right) \right]$$

The (-) sign in the function $\ln f(x, \eta)$ changes the maximization problem to minimization problem. Thus, it is simplified to,

$$\hat{\eta} = \min_{\eta} \frac{1}{2N_s} \sum_{i=1}^{N_s} I_i \left[\left(\ln(2\pi) + \ln(\sigma^2) + \frac{(x_i - \mu)^2}{\sigma^2} \right) \right]$$

From inspection, the optimal solution of the above term dependent upon the minimization of the term,

$$\ln(\sigma^2) \sum_{i=1}^{N_s} I_i + \frac{1}{\sigma^2} \sum_{i=1}^{N_s} I_i (x_i - \mu)^2$$

By computing first derivatives and setting the results equal to zero,

$$\frac{\partial}{\partial \mu} \left(\ln(\sigma^2) \sum_{i=1}^{N_s} I_i + \frac{1}{\sigma^2} \sum_{i=1}^{N_s} I_i (x_i - \mu)^2 \right) = \frac{2}{\sigma^2} \left(\sum_{i=1}^{N_s} I_i \mu - \sum_{i=1}^{N_s} I_i x_i \right) = 0$$

$$\frac{\partial}{\partial \sigma^2} \left(\ln(\sigma^2) \sum_{i=1}^{N_s} I_i + \frac{1}{\sigma^2} \sum_{i=1}^{N_s} I_i (x_i - \mu)^2 \right) = \frac{1}{\sigma^2} \sum_{i=1}^{N_s} I_i \mu - \frac{1}{(\sigma^2)^2} \sum_{i=1}^{N_s} I_i (x_i - \mu)^2 = 0$$

Solving for μ and σ^2 results in,

$$\hat{\mu} = \frac{\sum_{i=1}^{N_s} I_i x_i}{\sum_{i=1}^{N_s} I_i} \quad \text{and,} \quad \hat{\sigma}^2 = \frac{\sum_{i=1}^{N_s} I_i (x_i - \hat{\mu})^2}{\sum_{i=1}^{N_s} I_i}$$

Cross Entropy Method for Combinatorial Optimization

By choosing a density function which is binary in nature, e.g., which is the Bernoulli distribution, $\text{Ber}(p)$ with success probability p represented by the pdf,

$$f(x; p) = p^x (1-p)^{1-x}, \quad x \in \{0, 1\}$$

where $f(x; p)$ equals p when $x=1$ and, when $x=0$ $1-p$.

The estimated CE update parameter for the Bernoulli success probability is determined by solving,

$$\hat{v}^{(t)} = \max_v \frac{1}{N_s} \sum_{i=1}^{N_s} I_{\{Z(x_i) \geq \hat{\gamma}^{(t)}\}} \ln f(x_i, v)$$

Thus, to expand the expression $\ln f(x; p)$,

$$\ln f(x_i; p) = x_i \ln(p) + (1-x_i) \ln(1-p)$$

The maximum of the CE program is determined by setting the first derivative of the above term with respect to p equal to zero,

$$\frac{\partial}{\partial p} \ln f(x_i; p) = \frac{x_i}{p} - \frac{1-x_i}{1-p} = \frac{x_i - p}{p(1-p)}$$

Thus,

$$\frac{\partial}{\partial p} \sum_{i=1}^{N_s} I_{\{Z(x_i) \geq \gamma\}} \ln f(x_i, p) = \frac{1}{p(1-p)} \sum_{i=1}^{N_s} I_{\{Z(x_i) \geq \gamma\}} (x_i - p) = 0$$

Solving for p yields the estimate of the optimal pdf parameter,

$$\hat{p} = \frac{\sum_{i=1}^{N_s} I_{\{Z(x_i) \geq \gamma\}} x_i}{\sum_{i=1}^{N_s} I_{\{Z(x_i) \geq \gamma\}}}$$

For more details about the CE method refer to Connor, J.D. (2008).

APPENDIX B

VARIOUS CONTAINER TERMINAL EQUIPMENTS



Figure App. B.1 Terminal tractors (Source: Kalmar Industries 2009)



Figure App. B.2 Forklift trucks (Source: Kalmar Industries 2009)



Figure App. B.3 Empty container handlers (Source: Kalmar Industries 2009)



Figure App. B.4 Loaded container handlers (Source: Kalmar Industries 2009)



Figure App. B.5 Log stackers (Bulk cargo) (Source: Kalmar Industries 2009)



Figure App. B.6 Reach stackers (Source: Kalmar Industries 2009)



Figure App. B.7 Straddle carriers (Source: Kalmar Industries 2009)



Figure App. B.8 Straddle carriers (Source: Kalmar Industries 2009)



Figure App. B.9 RTG cranes (Source: Kalmar Industries 2009)



Figure App. B.10 ASC – Automatic stacking crane (Source: Kalmar Industries 2009)

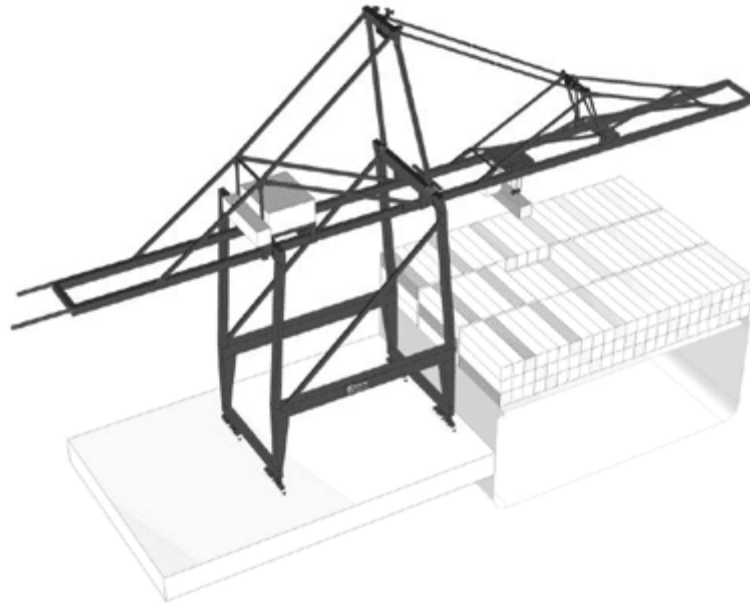

Figure App. B.11 Quay crane (Source: Kalmar Industries 2009)

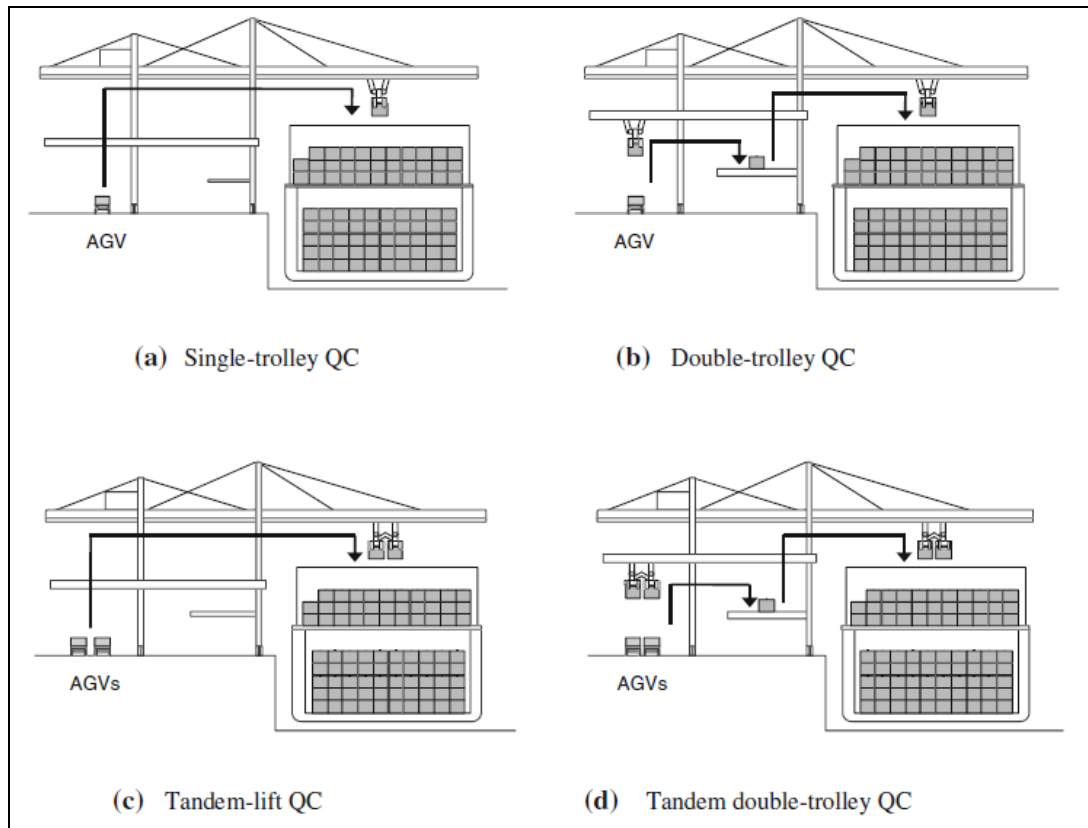

Figure App. B.12 Various types of quay cranes (Source: Bae et al., 2009)

APPENDIX C

LOGISTICS PERFORMANCE INDEX – COUNTRIES AND INDICATORS

Tables and figures data source: The World Bank – World Development Index (WDI) database (1=Low, 5=High)

Country Name	Indicator Name	2006	2009
Afghanistan	Ability to track and trace consignments	1,00	2,37
	Competence and quality of logistics services	1,25	2,09
	Ease of arranging competitively priced shipments	1,22	2,24
	Efficiency of customs clearance process	1,30	2,22
	Frequency with which shipments reach consignee within scheduled or expected time	1,38	2,61
	Quality of trade and transport-related infrastructure	1,10	1,87
	Overall	1,21	2,24
Albania	Ability to track and trace consignments	1,67	2,39
	Competence and quality of logistics services	2,00	2,39
	Ease of arranging competitively priced shipments	2,33	2,64
	Efficiency of customs clearance process	2,00	2,07
	Frequency with which shipments reach consignee within scheduled or expected time	2,13	3,01
	Quality of trade and transport-related infrastructure	2,33	2,14
	Overall	2,08	2,46
Algeria	Ability to track and trace consignments	2,27	2,26
	Competence and quality of logistics services	1,92	2,24
	Ease of arranging competitively priced shipments	2,00	2,70
	Efficiency of customs clearance process	1,60	1,97
	Frequency with which shipments reach consignee within scheduled or expected time	2,82	2,81
	Quality of trade and transport-related infrastructure	1,83	2,06
	Overall	2,06	2,36
American Samoa	Ability to track and trace consignments	-	-
	Competence and quality of logistics services	-	-
	Ease of arranging competitively priced shipments	-	-
	Efficiency of customs clearance process	-	-
	Frequency with which shipments reach consignee within scheduled or expected time	-	-
	Quality of trade and transport-related infrastructure	-	-
	Overall		
Andorra	Ability to track and trace consignments	-	-
	Competence and quality of logistics services	-	-
	Ease of arranging competitively priced shipments	-	-
	Efficiency of customs clearance process	-	-
	Frequency with which shipments reach consignee within scheduled or expected time	-	-
	Quality of trade and transport-related infrastructure	-	-
	Overall		

Country Name	Indicator Name	2006	2009
Angola	Ability to track and trace consignments	2,38	2,54
	Competence and quality of logistics services	2,50	2,02
	Ease of arranging competitively priced shipments	2,50	2,38
	Efficiency of customs clearance process	2,40	1,75
	Frequency with which shipments reach consignee within scheduled or expected time	2,83	3,01
	Quality of trade and transport-related infrastructure	2,25	1,69
	Overall	2,48	2,25
Antigua and Barbuda	Ability to track and trace consignments	-	-
	Competence and quality of logistics services	-	-
	Ease of arranging competitively priced shipments	-	-
	Efficiency of customs clearance process	-	-
	Frequency with which shipments reach consignee within scheduled or expected time	-	-
	Quality of trade and transport-related infrastructure	-	-
	Overall		
Arab World	Ability to track and trace consignments	2,63	2,61
	Competence and quality of logistics services	2,56	2,59
	Ease of arranging competitively priced shipments	2,60	2,65
	Efficiency of customs clearance process	2,44	2,46
	Frequency with which shipments reach consignee within scheduled or expected time	3,11	3,32
	Quality of trade and transport-related infrastructure	2,46	2,54
	Overall	2,63	2,70
Argentina	Ability to track and trace consignments	3,00	3,15
	Competence and quality of logistics services	3,00	3,03
	Ease of arranging competitively priced shipments	2,97	3,15
	Efficiency of customs clearance process	2,65	2,63
	Frequency with which shipments reach consignee within scheduled or expected time	3,50	3,82
	Quality of trade and transport-related infrastructure	2,81	2,75
	Overall	2,98	3,10
Armenia	Ability to track and trace consignments	2,22	2,26
	Competence and quality of logistics services	2,11	2,59
	Ease of arranging competitively priced shipments	2,00	2,43
	Efficiency of customs clearance process	2,10	2,10
	Frequency with which shipments reach consignee within scheduled or expected time	2,63	3,40
	Quality of trade and transport-related infrastructure	1,78	2,32
	Overall	2,14	2,52

Country Name	Indicator Name	2006	2009
Aruba	Ability to track and trace consignments	-	-
	Competence and quality of logistics services	-	-
	Ease of arranging competitively priced shipments	-	-
	Efficiency of customs clearance process	-	-
	Frequency with which shipments reach consignee within scheduled or expected time	-	-
	Quality of trade and transport-related infrastructure	-	-
	Overall		
Australia	Ability to track and trace consignments	3,97	3,87
	Competence and quality of logistics services	3,76	3,77
	Ease of arranging competitively priced shipments	3,72	3,78
	Efficiency of customs clearance process	3,58	3,68
	Frequency with which shipments reach consignee within scheduled or expected time	4,10	4,16
	Quality of trade and transport-related infrastructure	3,65	3,78
	Overall	3,79	3,84
Austria	Ability to track and trace consignments	3,97	3,83
	Competence and quality of logistics services	4,13	3,70
	Ease of arranging competitively priced shipments	3,97	3,78
	Efficiency of customs clearance process	3,83	3,49
	Frequency with which shipments reach consignee within scheduled or expected time	4,44	4,08
	Quality of trade and transport-related infrastructure	4,06	3,68
	Overall	4,06	3,76
Azerbaijan	Ability to track and trace consignments	2,38	2,65
	Competence and quality of logistics services	2,00	2,48
	Ease of arranging competitively priced shipments	2,50	3,05
	Efficiency of customs clearance process	2,23	2,14
	Frequency with which shipments reach consignee within scheduled or expected time	2,63	3,15
	Quality of trade and transport-related infrastructure	2,00	2,23
	Overall	2,29	2,64
Bahamas, The	Ability to track and trace consignments	-	2,81
	Competence and quality of logistics services	-	2,69
	Ease of arranging competitively priced shipments	-	2,69
	Efficiency of customs clearance process	-	2,38
	Frequency with which shipments reach consignee within scheduled or expected time	-	3,46
	Quality of trade and transport-related infrastructure	-	2,40
	Overall		2,75

Country Name	Indicator Name	2006	2009
Bahrain	Ability to track and trace consignments	3,00	3,63
	Competence and quality of logistics services	2,75	3,36
	Ease of arranging competitively priced shipments	3,33	3,05
	Efficiency of customs clearance process	3,40	3,05
	Frequency with which shipments reach consignee within scheduled or expected time	3,00	3,85
	Quality of trade and transport-related infrastructure	3,40	3,36
	Overall	3,15	3,37
Bangladesh	Ability to track and trace consignments	2,46	2,64
	Competence and quality of logistics services	2,33	2,44
	Ease of arranging competitively priced shipments	2,46	2,99
	Efficiency of customs clearance process	2,00	2,33
	Frequency with which shipments reach consignee within scheduled or expected time	3,33	3,46
	Quality of trade and transport-related infrastructure	2,29	2,49
	Overall	2,47	2,74
Barbados	Ability to track and trace consignments	-	-
	Competence and quality of logistics services	-	-
	Ease of arranging competitively priced shipments	-	-
	Efficiency of customs clearance process	-	-
	Frequency with which shipments reach consignee within scheduled or expected time	-	-
	Quality of trade and transport-related infrastructure	-	-
	Overall	-	-
Belarus	Ability to track and trace consignments	2,71	-
	Competence and quality of logistics services	2,13	-
	Ease of arranging competitively priced shipments	2,13	-
	Efficiency of customs clearance process	2,67	-
	Frequency with which shipments reach consignee within scheduled or expected time	3,00	-
	Quality of trade and transport-related infrastructure	2,63	-
	Overall	2,53	-
Belgium	Ability to track and trace consignments	3,96	4,22
	Competence and quality of logistics services	3,95	4,13
	Ease of arranging competitively priced shipments	3,65	3,31
	Efficiency of customs clearance process	3,61	3,83
	Frequency with which shipments reach consignee within scheduled or expected time	4,25	4,29
	Quality of trade and transport-related infrastructure	4,00	4,01
	Overall	3,89	3,94

Country Name	Indicator Name	2006	2009
Belize	Ability to track and trace consignments	-	-
	Competence and quality of logistics services	-	-
	Ease of arranging competitively priced shipments	-	-
	Efficiency of customs clearance process	-	-
	Frequency with which shipments reach consignee within scheduled or expected time	-	-
	Quality of trade and transport-related infrastructure	-	-
	Overall		
Benin	Ability to track and trace consignments	2,89	3,07
	Competence and quality of logistics services	2,56	2,64
	Ease of arranging competitively priced shipments	2,78	2,65
	Efficiency of customs clearance process	1,80	2,38
	Frequency with which shipments reach consignee within scheduled or expected time	2,78	3,49
	Quality of trade and transport-related infrastructure	1,89	2,48
	Overall	2,45	2,79
Bermuda	Ability to track and trace consignments	-	-
	Competence and quality of logistics services	-	-
	Ease of arranging competitively priced shipments	-	-
	Efficiency of customs clearance process	-	-
	Frequency with which shipments reach consignee within scheduled or expected time	-	-
	Quality of trade and transport-related infrastructure	-	-
	Overall		
Bhutan	Ability to track and trace consignments	2,27	2,54
	Competence and quality of logistics services	2,18	2,24
	Ease of arranging competitively priced shipments	2,06	2,44
	Efficiency of customs clearance process	1,95	2,14
	Frequency with which shipments reach consignee within scheduled or expected time	2,57	2,99
	Quality of trade and transport-related infrastructure	1,95	1,83
	Overall	2,16	2,38
Bolivia	Ability to track and trace consignments	2,38	2,38
	Competence and quality of logistics services	2,17	2,38
	Ease of arranging competitively priced shipments	2,42	2,53
	Efficiency of customs clearance process	2,00	2,26
	Frequency with which shipments reach consignee within scheduled or expected time	2,81	3,20
	Quality of trade and transport-related infrastructure	2,08	2,24
	Overall	2,31	2,51

Country Name	Indicator Name	2006	2009
Bosnia and Herzegovina	Ability to track and trace consignments	2,29	2,68
	Competence and quality of logistics services	2,37	2,30
	Ease of arranging competitively priced shipments	2,50	3,10
	Efficiency of customs clearance process	2,32	2,33
	Frequency with which shipments reach consignee within scheduled or expected time	3,00	3,18
	Quality of trade and transport-related infrastructure	2,26	2,22
	Overall	2,46	2,66
Botswana	Ability to track and trace consignments	-	2,59
	Competence and quality of logistics services	-	2,29
	Ease of arranging competitively priced shipments	-	1,91
	Efficiency of customs clearance process	-	2,09
	Frequency with which shipments reach consignee within scheduled or expected time	-	2,99
	Quality of trade and transport-related infrastructure	-	2,09
	Overall		2,32
Brazil	Ability to track and trace consignments	2,77	3,42
	Competence and quality of logistics services	2,94	3,30
	Ease of arranging competitively priced shipments	2,61	2,91
	Efficiency of customs clearance process	2,39	2,37
	Frequency with which shipments reach consignee within scheduled or expected time	3,10	4,14
	Quality of trade and transport-related infrastructure	2,75	3,10
	Overall	2,75	3,20
Brunei Darussalam	Ability to track and trace consignments	-	-
	Competence and quality of logistics services	-	-
	Ease of arranging competitively priced shipments	-	-
	Efficiency of customs clearance process	-	-
	Frequency with which shipments reach consignee within scheduled or expected time	-	-
	Quality of trade and transport-related infrastructure	-	-
	Overall		
Bulgaria	Ability to track and trace consignments	3,14	2,96
	Competence and quality of logistics services	2,86	2,85
	Ease of arranging competitively priced shipments	2,79	3,07
	Efficiency of customs clearance process	2,47	2,50
	Frequency with which shipments reach consignee within scheduled or expected time	3,56	3,18
	Quality of trade and transport-related infrastructure	2,47	2,30
	Overall	2,87	2,83

Country Name	Indicator Name	2006	2009
Burkina Faso	Ability to track and trace consignments	2,13	2,77
	Competence and quality of logistics services	2,33	2,02
	Ease of arranging competitively priced shipments	2,67	1,73
	Efficiency of customs clearance process	2,13	2,22
	Frequency with which shipments reach consignee within scheduled or expected time	2,25	2,77
	Quality of trade and transport-related infrastructure	1,89	1,89
	Overall	2,24	2,23
Burundi	Ability to track and trace consignments	2,00	-
	Competence and quality of logistics services	2,50	-
	Ease of arranging competitively priced shipments	2,50	-
	Efficiency of customs clearance process	2,20	-
	Frequency with which shipments reach consignee within scheduled or expected time	2,00	-
	Quality of trade and transport-related infrastructure	2,50	-
	Overall	2,29	
Cambodia	Ability to track and trace consignments	2,53	2,50
	Competence and quality of logistics services	2,47	2,29
	Ease of arranging competitively priced shipments	2,47	2,19
	Efficiency of customs clearance process	2,19	2,28
	Frequency with which shipments reach consignee within scheduled or expected time	3,05	2,84
	Quality of trade and transport-related infrastructure	2,30	2,12
	Overall	2,50	2,37
Cameroon	Ability to track and trace consignments	2,50	2,60
	Competence and quality of logistics services	2,25	2,53
	Ease of arranging competitively priced shipments	2,33	2,69
	Efficiency of customs clearance process	2,57	2,11
	Frequency with which shipments reach consignee within scheduled or expected time	3,29	3,16
	Quality of trade and transport-related infrastructure	2,00	2,10
	Overall	2,49	2,55
Canada	Ability to track and trace consignments	3,98	4,01
	Competence and quality of logistics services	3,85	3,99
	Ease of arranging competitively priced shipments	3,78	3,24
	Efficiency of customs clearance process	3,82	3,71
	Frequency with which shipments reach consignee within scheduled or expected time	4,19	4,41
	Quality of trade and transport-related infrastructure	3,95	4,03
	Overall	3,92	3,87

Country Name	Indicator Name	2006	2009
Cape Verde	Ability to track and trace consignments	-	-
	Competence and quality of logistics services	-	-
	Ease of arranging competitively priced shipments	-	-
	Efficiency of customs clearance process	-	-
	Frequency with which shipments reach consignee within scheduled or expected time	-	-
	Quality of trade and transport-related infrastructure	-	-
	Overall		
Cayman Islands	Ability to track and trace consignments	-	-
	Competence and quality of logistics services	-	-
	Ease of arranging competitively priced shipments	-	-
	Efficiency of customs clearance process	-	-
	Frequency with which shipments reach consignee within scheduled or expected time	-	-
	Quality of trade and transport-related infrastructure	-	-
	Overall		
Central African Republic	Ability to track and trace consignments	-	-
	Competence and quality of logistics services	-	-
	Ease of arranging competitively priced shipments	-	-
	Efficiency of customs clearance process	-	-
	Frequency with which shipments reach consignee within scheduled or expected time	-	-
	Quality of trade and transport-related infrastructure	-	-
	Overall		
Chad	Ability to track and trace consignments	1,91	2,62
	Competence and quality of logistics services	1,82	2,04
	Ease of arranging competitively priced shipments	1,83	2,75
	Efficiency of customs clearance process	2,00	2,27
	Frequency with which shipments reach consignee within scheduled or expected time	2,56	3,14
	Quality of trade and transport-related infrastructure	1,80	2,00
	Overall	1,98	2,49
Channel Islands	Ability to track and trace consignments	-	-
	Competence and quality of logistics services	-	-
	Ease of arranging competitively priced shipments	-	-
	Efficiency of customs clearance process	-	-
	Frequency with which shipments reach consignee within scheduled or expected time	-	-
	Quality of trade and transport-related infrastructure	-	-
	Overall		

Country Name	Indicator Name	2006	2009
Chile	Ability to track and trace consignments	3,17	3,33
	Competence and quality of logistics services	3,19	2,94
	Ease of arranging competitively priced shipments	3,21	2,74
	Efficiency of customs clearance process	3,32	2,93
	Frequency with which shipments reach consignee within scheduled or expected time	3,55	3,80
	Quality of trade and transport-related infrastructure	3,06	2,86
	Overall	3,25	3,09
China	Ability to track and trace consignments	3,37	3,55
	Competence and quality of logistics services	3,40	3,49
	Ease of arranging competitively priced shipments	3,31	3,31
	Efficiency of customs clearance process	2,99	3,16
	Frequency with which shipments reach consignee within scheduled or expected time	3,68	3,91
	Quality of trade and transport-related infrastructure	3,20	3,54
	Overall	3,32	3,49
Colombia	Ability to track and trace consignments	2,63	2,75
	Competence and quality of logistics services	2,44	2,75
	Ease of arranging competitively priced shipments	2,61	2,54
	Efficiency of customs clearance process	2,10	2,50
	Frequency with which shipments reach consignee within scheduled or expected time	2,94	3,52
	Quality of trade and transport-related infrastructure	2,28	2,59
	Overall	2,50	2,77
Comoros	Ability to track and trace consignments	2,50	2,79
	Competence and quality of logistics services	2,64	2,26
	Ease of arranging competitively priced shipments	2,33	2,56
	Efficiency of customs clearance process	2,30	1,96
	Frequency with which shipments reach consignee within scheduled or expected time	2,67	3,23
	Quality of trade and transport-related infrastructure	2,46	1,76
	Overall	2,48	2,45
Congo, Dem. Rep.	Ability to track and trace consignments	-	2,43
	Competence and quality of logistics services	-	2,93
	Ease of arranging competitively priced shipments	-	2,56
	Efficiency of customs clearance process	-	2,60
	Frequency with which shipments reach consignee within scheduled or expected time	-	3,20
	Quality of trade and transport-related infrastructure	-	2,27
	Overall		2,68

Country Name	Indicator Name	2006	2009
Congo, Rep.	Ability to track and trace consignments	-	2,33
	Competence and quality of logistics services	-	2,42
	Ease of arranging competitively priced shipments	-	2,33
	Efficiency of customs clearance process	-	2,02
	Frequency with which shipments reach consignee within scheduled or expected time	-	4,00
	Quality of trade and transport-related infrastructure	-	1,62
	Overall		2,48
Costa Rica	Ability to track and trace consignments	2,57	3,13
	Competence and quality of logistics services	2,43	2,80
	Ease of arranging competitively priced shipments	2,53	2,64
	Efficiency of customs clearance process	2,49	2,61
	Frequency with which shipments reach consignee within scheduled or expected time	2,89	3,71
	Quality of trade and transport-related infrastructure	2,43	2,56
	Overall	2,55	2,91
Cote d'Ivoire	Ability to track and trace consignments	2,00	2,95
	Competence and quality of logistics services	2,38	2,57
	Ease of arranging competitively priced shipments	2,13	2,44
	Efficiency of customs clearance process	2,22	2,16
	Frequency with which shipments reach consignee within scheduled or expected time	3,25	2,73
	Quality of trade and transport-related infrastructure	2,22	2,37
	Overall	2,36	2,53
Croatia	Ability to track and trace consignments	2,46	2,82
	Competence and quality of logistics services	2,83	2,53
	Ease of arranging competitively priced shipments	2,69	2,97
	Efficiency of customs clearance process	2,36	2,62
	Frequency with which shipments reach consignee within scheduled or expected time	3,45	3,22
	Quality of trade and transport-related infrastructure	2,50	2,36
	Overall	2,71	2,77
Cuba	Ability to track and trace consignments	-	2,03
	Competence and quality of logistics services	-	1,88
	Ease of arranging competitively priced shipments	-	2,32
	Efficiency of customs clearance process	-	1,79
	Frequency with which shipments reach consignee within scheduled or expected time	-	2,41
	Quality of trade and transport-related infrastructure	-	1,90
	Overall		2,07

Country Name	Indicator Name	2006	2009
Cyprus	Ability to track and trace consignments	2,92	3,51
	Competence and quality of logistics services	2,77	2,82
	Ease of arranging competitively priced shipments	2,92	3,13
	Efficiency of customs clearance process	2,77	2,92
	Frequency with which shipments reach consignee within scheduled or expected time	3,25	3,44
	Quality of trade and transport-related infrastructure	2,91	2,94
	Overall	2,92	3,13
Czech Republic	Ability to track and trace consignments	3,27	3,60
	Competence and quality of logistics services	3,00	3,27
	Ease of arranging competitively priced shipments	3,06	3,42
	Efficiency of customs clearance process	2,95	3,31
	Frequency with which shipments reach consignee within scheduled or expected time	3,56	4,16
	Quality of trade and transport-related infrastructure	3,00	3,25
	Overall	3,13	3,51
Denmark	Ability to track and trace consignments	3,76	3,94
	Competence and quality of logistics services	3,83	3,83
	Ease of arranging competitively priced shipments	3,67	3,46
	Efficiency of customs clearance process	3,97	3,58
	Frequency with which shipments reach consignee within scheduled or expected time	4,11	4,38
	Quality of trade and transport-related infrastructure	3,82	3,99
	Overall	3,86	3,85
Djibouti	Ability to track and trace consignments	1,82	2,42
	Competence and quality of logistics services	2,00	2,17
	Ease of arranging competitively priced shipments	2,00	2,50
	Efficiency of customs clearance process	1,64	2,25
	Frequency with which shipments reach consignee within scheduled or expected time	2,30	2,67
	Quality of trade and transport-related infrastructure	1,92	2,33
	Overall	1,94	2,39
Dominica	Ability to track and trace consignments	-	-
	Competence and quality of logistics services	-	-
	Ease of arranging competitively priced shipments	-	-
	Efficiency of customs clearance process	-	-
	Frequency with which shipments reach consignee within scheduled or expected time	-	-
	Quality of trade and transport-related infrastructure	-	-
	Overall	-	-

Country Name	Indicator Name	2006	2009
Dominican Republic	Ability to track and trace consignments	2,28	3,17
	Competence and quality of logistics services	2,25	2,42
	Ease of arranging competitively priced shipments	2,34	2,59
	Efficiency of customs clearance process	2,33	2,51
	Frequency with which shipments reach consignee within scheduled or expected time	2,89	3,85
	Quality of trade and transport-related infrastructure	2,18	2,34
	Overall	2,38	2,82
East Asia & Pacific (all income levels)	Ability to track and trace consignments	3,01	3,16
	Competence and quality of logistics services	3,01	3,01
	Ease of arranging competitively priced shipments	3,02	3,08
	Efficiency of customs clearance process	2,82	2,85
	Frequency with which shipments reach consignee within scheduled or expected time	3,42	3,60
	Quality of trade and transport-related infrastructure	2,88	2,94
	Overall	3,02	3,11
East Asia & Pacific (developing only)	Ability to track and trace consignments	2,53	2,74
	Competence and quality of logistics services	2,54	2,58
	Ease of arranging competitively priced shipments	2,64	2,79
	Efficiency of customs clearance process	2,41	2,41
	Frequency with which shipments reach consignee within scheduled or expected time	3,01	3,33
	Quality of trade and transport-related infrastructure	2,37	2,46
	Overall	2,58	2,73
Ecuador	Ability to track and trace consignments	2,45	2,84
	Competence and quality of logistics services	2,64	2,60
	Ease of arranging competitively priced shipments	2,64	2,86
	Efficiency of customs clearance process	2,25	2,32
	Frequency with which shipments reach consignee within scheduled or expected time	3,27	3,55
	Quality of trade and transport-related infrastructure	2,36	2,38
	Overall	2,60	2,77
Egypt, Arab Rep.	Ability to track and trace consignments	2,62	2,56
	Competence and quality of logistics services	2,38	2,87
	Ease of arranging competitively priced shipments	2,33	2,56
	Efficiency of customs clearance process	2,08	2,11
	Frequency with which shipments reach consignee within scheduled or expected time	2,85	3,31
	Quality of trade and transport-related infrastructure	2,00	2,22
	Overall	2,37	2,61

Country Name	Indicator Name	2006	2009
El Salvador	Ability to track and trace consignments	2,82	2,68
	Competence and quality of logistics services	2,53	2,66
	Ease of arranging competitively priced shipments	2,78	2,18
	Efficiency of customs clearance process	2,38	2,48
	Frequency with which shipments reach consignee within scheduled or expected time	3,06	3,63
	Quality of trade and transport-related infrastructure	2,42	2,44
	Overall	2,66	2,67
Equatorial Guinea	Ability to track and trace consignments	-	-
	Competence and quality of logistics services	-	-
	Ease of arranging competitively priced shipments	-	-
	Efficiency of customs clearance process	-	-
	Frequency with which shipments reach consignee within scheduled or expected time	-	-
	Quality of trade and transport-related infrastructure	-	-
	Overall		
Eritrea	Ability to track and trace consignments	2,50	1,55
	Competence and quality of logistics services	2,67	1,88
	Ease of arranging competitively priced shipments	2,00	1,63
	Efficiency of customs clearance process	2,14	1,50
	Frequency with which shipments reach consignee within scheduled or expected time	1,83	2,21
	Quality of trade and transport-related infrastructure	2,00	1,35
	Overall	2,19	1,70
Estonia	Ability to track and trace consignments	2,84	2,95
	Competence and quality of logistics services	3,00	3,17
	Ease of arranging competitively priced shipments	2,85	3,17
	Efficiency of customs clearance process	2,75	3,14
	Frequency with which shipments reach consignee within scheduled or expected time	3,35	3,68
	Quality of trade and transport-related infrastructure	2,91	2,75
	Overall	2,95	3,16
Ethiopia	Ability to track and trace consignments	1,83	2,89
	Competence and quality of logistics services	2,00	2,14
	Ease of arranging competitively priced shipments	2,43	2,76
	Efficiency of customs clearance process	2,14	2,13
	Frequency with which shipments reach consignee within scheduled or expected time	3,67	2,65
	Quality of trade and transport-related infrastructure	1,88	1,77
	Overall	2,33	2,41

Country Name	Indicator Name	2006	2009
Euro area	Ability to track and trace consignments	3,65	3,73
	Competence and quality of logistics services	3,59	3,53
	Ease of arranging competitively priced shipments	3,45	3,29
	Efficiency of customs clearance process	3,39	3,38
	Frequency with which shipments reach consignee within scheduled or expected time	4,01	3,99
	Quality of trade and transport-related infrastructure	3,59	3,57
	Overall	3,61	3,57
Europe & Central Asia (all income levels)	Ability to track and trace consignments	3,08	3,27
	Competence and quality of logistics services	3,04	3,10
	Ease of arranging competitively priced shipments	3,02	3,13
	Efficiency of customs clearance process	2,89	2,92
	Frequency with which shipments reach consignee within scheduled or expected time	3,51	3,69
	Quality of trade and transport-related infrastructure	2,97	3,03
	Overall	3,08	3,19
Europe & Central Asia (developing only)	Ability to track and trace consignments	2,40	2,68
	Competence and quality of logistics services	2,36	2,55
	Ease of arranging competitively priced shipments	2,46	2,89
	Efficiency of customs clearance process	2,26	2,29
	Frequency with which shipments reach consignee within scheduled or expected time	2,86	3,25
	Quality of trade and transport-related infrastructure	2,24	2,36
	Overall	2,43	2,68
European Union	Ability to track and trace consignments	3,49	3,61
	Competence and quality of logistics services	3,43	3,42
	Ease of arranging competitively priced shipments	3,36	3,30
	Efficiency of customs clearance process	3,24	3,27
	Frequency with which shipments reach consignee within scheduled or expected time	3,88	3,96
	Quality of trade and transport-related infrastructure	3,37	3,38
	Overall	3,46	3,49
Faeroe Islands	Ability to track and trace consignments	-	-
	Competence and quality of logistics services	-	-
	Ease of arranging competitively priced shipments	-	-
	Efficiency of customs clearance process	-	-
	Frequency with which shipments reach consignee within scheduled or expected time	-	-
	Quality of trade and transport-related infrastructure	-	-
	Overall		

Country Name	Indicator Name	2006	2009
Fiji	Ability to track and trace consignments	-	1,96
	Competence and quality of logistics services	-	2,11
	Ease of arranging competitively priced shipments	-	2,48
	Efficiency of customs clearance process	-	1,95
	Frequency with which shipments reach consignee within scheduled or expected time	-	2,82
	Quality of trade and transport-related infrastructure	-	1,98
	Overall		2,24
Finland	Ability to track and trace consignments	4,17	4,09
	Competence and quality of logistics services	3,85	3,92
	Ease of arranging competitively priced shipments	3,30	3,41
	Efficiency of customs clearance process	3,68	3,86
	Frequency with which shipments reach consignee within scheduled or expected time	4,18	4,08
	Quality of trade and transport-related infrastructure	3,81	4,08
	Overall	3,82	3,89
France	Ability to track and trace consignments	3,87	4,01
	Competence and quality of logistics services	3,76	3,87
	Ease of arranging competitively priced shipments	3,63	3,30
	Efficiency of customs clearance process	3,51	3,63
	Frequency with which shipments reach consignee within scheduled or expected time	4,02	4,37
	Quality of trade and transport-related infrastructure	3,82	4,00
	Overall	3,76	3,84
French Polynesia	Ability to track and trace consignments	-	-
	Competence and quality of logistics services	-	-
	Ease of arranging competitively priced shipments	-	-
	Efficiency of customs clearance process	-	-
	Frequency with which shipments reach consignee within scheduled or expected time	-	-
	Quality of trade and transport-related infrastructure	-	-
	Overall		
Gabon	Ability to track and trace consignments	2,00	2,67
	Competence and quality of logistics services	2,00	2,31
	Ease of arranging competitively priced shipments	1,67	2,29
	Efficiency of customs clearance process	2,25	2,23
	Frequency with which shipments reach consignee within scheduled or expected time	2,33	2,87
	Quality of trade and transport-related infrastructure	2,40	2,09
	Overall	2,10	2,41

Country Name	Indicator Name	2006	2009
Gambia, The	Ability to track and trace consignments	2,33	2,27
	Competence and quality of logistics services	3,00	2,37
	Ease of arranging competitively priced shipments	2,67	2,54
	Efficiency of customs clearance process	2,25	2,38
	Frequency with which shipments reach consignee within scheduled or expected time	2,50	3,15
	Quality of trade and transport-related infrastructure	2,33	2,17
	Overall	2,52	2,49
Georgia	Ability to track and trace consignments	-	2,67
	Competence and quality of logistics services	-	2,57
	Ease of arranging competitively priced shipments	-	2,73
	Efficiency of customs clearance process	-	2,37
	Frequency with which shipments reach consignee within scheduled or expected time	-	3,08
	Quality of trade and transport-related infrastructure	-	2,17
	Overall		2,61
Germany	Ability to track and trace consignments	4,12	4,18
	Competence and quality of logistics services	4,21	4,14
	Ease of arranging competitively priced shipments	3,91	3,66
	Efficiency of customs clearance process	3,88	4,00
	Frequency with which shipments reach consignee within scheduled or expected time	4,33	4,48
	Quality of trade and transport-related infrastructure	4,19	4,34
	Overall	4,10	4,11
Ghana	Ability to track and trace consignments	2,25	2,51
	Competence and quality of logistics services	1,75	2,42
	Ease of arranging competitively priced shipments	2,25	2,38
	Efficiency of customs clearance process	2,00	2,35
	Frequency with which shipments reach consignee within scheduled or expected time	2,50	2,67
	Quality of trade and transport-related infrastructure	2,25	2,52
	Overall	2,16	2,47
Gibraltar	Ability to track and trace consignments	-	-
	Competence and quality of logistics services	-	-
	Ease of arranging competitively priced shipments	-	-
	Efficiency of customs clearance process	-	-
	Frequency with which shipments reach consignee within scheduled or expected time	-	-
	Quality of trade and transport-related infrastructure	-	-
	Overall		

Country Name	Indicator Name	2006	2009
Greece	Ability to track and trace consignments	3,53	3,31
	Competence and quality of logistics services	3,33	2,69
	Ease of arranging competitively priced shipments	3,11	2,85
	Efficiency of customs clearance process	3,06	2,48
	Frequency with which shipments reach consignee within scheduled or expected time	4,13	3,49
	Quality of trade and transport-related infrastructure	3,05	2,94
	Overall	3,36	2,96
Greenland	Ability to track and trace consignments	-	-
	Competence and quality of logistics services	-	-
	Ease of arranging competitively priced shipments	-	-
	Efficiency of customs clearance process	-	-
	Frequency with which shipments reach consignee within scheduled or expected time	-	-
	Quality of trade and transport-related infrastructure	-	-
	Overall		
Grenada	Ability to track and trace consignments	-	-
	Competence and quality of logistics services	-	-
	Ease of arranging competitively priced shipments	-	-
	Efficiency of customs clearance process	-	-
	Frequency with which shipments reach consignee within scheduled or expected time	-	-
	Quality of trade and transport-related infrastructure	-	-
	Overall		
Guam	Ability to track and trace consignments	-	-
	Competence and quality of logistics services	-	-
	Ease of arranging competitively priced shipments	-	-
	Efficiency of customs clearance process	-	-
	Frequency with which shipments reach consignee within scheduled or expected time	-	-
	Quality of trade and transport-related infrastructure	-	-
	Overall		
Guatemala	Ability to track and trace consignments	2,43	2,71
	Competence and quality of logistics services	2,50	2,74
	Ease of arranging competitively priced shipments	2,62	2,16
	Efficiency of customs clearance process	2,27	2,33
	Frequency with which shipments reach consignee within scheduled or expected time	3,23	3,52
	Quality of trade and transport-related infrastructure	2,13	2,37
	Overall	2,53	2,63

Country Name	Indicator Name	2006	2009
Guinea	Ability to track and trace consignments	2,83	2,89
	Competence and quality of logistics services	2,67	2,68
	Ease of arranging competitively priced shipments	2,50	2,43
	Efficiency of customs clearance process	2,50	2,34
	Frequency with which shipments reach consignee within scheduled or expected time	3,50	3,10
	Quality of trade and transport-related infrastructure	2,33	2,10
	Overall	2,71	2,60
Guinea-Bissau	Ability to track and trace consignments	2,22	1,71
	Competence and quality of logistics services	2,00	1,56
	Ease of arranging competitively priced shipments	2,22	2,75
	Efficiency of customs clearance process	2,14	1,89
	Frequency with which shipments reach consignee within scheduled or expected time	2,86	2,91
	Quality of trade and transport-related infrastructure	2,25	1,56
	Overall	2,28	2,10
Guyana	Ability to track and trace consignments	2,35	2,28
	Competence and quality of logistics services	1,95	2,25
	Ease of arranging competitively priced shipments	1,80	2,31
	Efficiency of customs clearance process	1,95	2,02
	Frequency with which shipments reach consignee within scheduled or expected time	2,50	2,70
	Quality of trade and transport-related infrastructure	1,78	1,99
	Overall	2,05	2,27
Haiti	Ability to track and trace consignments	2,16	2,43
	Competence and quality of logistics services	2,11	2,46
	Ease of arranging competitively priced shipments	2,20	3,17
	Efficiency of customs clearance process	2,08	2,12
	Frequency with which shipments reach consignee within scheduled or expected time	2,60	3,02
	Quality of trade and transport-related infrastructure	2,14	2,17
	Overall	2,21	2,59
Heavily indebted poor countries (HIPC)	Ability to track and trace consignments	2,25	2,43
	Competence and quality of logistics services	2,29	2,26
	Ease of arranging competitively priced shipments	2,29	2,51
	Efficiency of customs clearance process	2,15	2,18
	Frequency with which shipments reach consignee within scheduled or expected time	2,70	2,96
	Quality of trade and transport-related infrastructure	2,03	2,03
	Overall	2,28	2,41

Country Name	Indicator Name	2006	2009
High income	Ability to track and trace consignments	3,57	3,64
	Competence and quality of logistics services	3,51	3,48
	Ease of arranging competitively priced shipments	3,41	3,28
	Efficiency of customs clearance process	3,31	3,35
	Frequency with which shipments reach consignee within scheduled or expected time	3,96	3,99
	Quality of trade and transport-related infrastructure	3,49	3,53
	Overall	3,54	3,54
High income: nonOECD	Ability to track and trace consignments	3,23	3,29
	Competence and quality of logistics services	3,17	3,14
	Ease of arranging competitively priced shipments	3,18	3,12
	Efficiency of customs clearance process	2,95	3,04
	Frequency with which shipments reach consignee within scheduled or expected time	3,75	3,70
	Quality of trade and transport-related infrastructure	3,17	3,17
	Overall	3,24	3,24
High income: OECD	Ability to track and trace consignments	3,75	3,85
	Competence and quality of logistics services	3,70	3,69
	Ease of arranging competitively priced shipments	3,54	3,37
	Efficiency of customs clearance process	3,51	3,53
	Frequency with which shipments reach consignee within scheduled or expected time	4,08	4,16
	Quality of trade and transport-related infrastructure	3,68	3,75
	Overall	3,70	3,72
Honduras	Ability to track and trace consignments	2,41	2,83
	Competence and quality of logistics services	2,41	2,57
	Ease of arranging competitively priced shipments	2,48	2,67
	Efficiency of customs clearance process	2,48	2,39
	Frequency with which shipments reach consignee within scheduled or expected time	2,88	3,83
	Quality of trade and transport-related infrastructure	2,32	2,31
	Overall	2,50	2,78
Hong Kong SAR, China	Ability to track and trace consignments	4,06	3,94
	Competence and quality of logistics services	3,99	3,83
	Ease of arranging competitively priced shipments	3,78	3,67
	Efficiency of customs clearance process	3,84	3,83
	Frequency with which shipments reach consignee within scheduled or expected time	4,33	4,04
	Quality of trade and transport-related infrastructure	4,06	4,00
	Overall	4,00	3,88

Country Name	Indicator Name	2006	2009
Hungary	Ability to track and trace consignments	3,00	2,87
	Competence and quality of logistics services	3,07	2,87
	Ease of arranging competitively priced shipments	3,07	2,78
	Efficiency of customs clearance process	3,00	2,83
	Frequency with which shipments reach consignee within scheduled or expected time	3,69	3,52
	Quality of trade and transport-related infrastructure	3,12	3,08
	Overall	3,15	2,99
Iceland	Ability to track and trace consignments	-	3,14
	Competence and quality of logistics services	-	3,14
	Ease of arranging competitively priced shipments	-	3,10
	Efficiency of customs clearance process	-	3,22
	Frequency with which shipments reach consignee within scheduled or expected time	-	3,27
	Quality of trade and transport-related infrastructure	-	3,33
	Overall		3,20
India	Ability to track and trace consignments	3,03	3,14
	Competence and quality of logistics services	3,27	3,16
	Ease of arranging competitively priced shipments	3,08	3,13
	Efficiency of customs clearance process	2,69	2,70
	Frequency with which shipments reach consignee within scheduled or expected time	3,47	3,61
	Quality of trade and transport-related infrastructure	2,90	2,91
	Overall	3,07	3,12
Indonesia	Ability to track and trace consignments	3,30	2,77
	Competence and quality of logistics services	2,90	2,47
	Ease of arranging competitively priced shipments	3,05	2,82
	Efficiency of customs clearance process	2,73	2,43
	Frequency with which shipments reach consignee within scheduled or expected time	3,28	3,46
	Quality of trade and transport-related infrastructure	2,83	2,54
	Overall	3,01	2,76
Iran, Islamic Rep.	Ability to track and trace consignments	2,00	2,50
	Competence and quality of logistics services	2,69	2,65
	Ease of arranging competitively priced shipments	2,59	2,44
	Efficiency of customs clearance process	2,50	2,22
	Frequency with which shipments reach consignee within scheduled or expected time	2,80	3,26
	Quality of trade and transport-related infrastructure	2,44	2,36
	Overall	2,51	2,57

Country Name	Indicator Name	2006	2009
Iraq	Ability to track and trace consignments	-	1,96
	Competence and quality of logistics services	-	2,10
	Ease of arranging competitively priced shipments	-	2,20
	Efficiency of customs clearance process	-	2,07
	Frequency with which shipments reach consignee within scheduled or expected time	-	2,49
	Quality of trade and transport-related infrastructure	-	1,73
	Overall		2,11
Ireland	Ability to track and trace consignments	3,96	4,02
	Competence and quality of logistics services	3,93	3,82
	Ease of arranging competitively priced shipments	3,76	3,70
	Efficiency of customs clearance process	3,82	3,60
	Frequency with which shipments reach consignee within scheduled or expected time	4,32	4,47
	Quality of trade and transport-related infrastructure	3,72	3,76
	Overall	3,91	3,89
Isle of Man	Ability to track and trace consignments	-	-
	Competence and quality of logistics services	-	-
	Ease of arranging competitively priced shipments	-	-
	Efficiency of customs clearance process	-	-
	Frequency with which shipments reach consignee within scheduled or expected time	-	-
	Quality of trade and transport-related infrastructure	-	-
	Overall		
Israel	Ability to track and trace consignments	3,46	3,39
	Competence and quality of logistics services	3,23	3,50
	Ease of arranging competitively priced shipments	3,27	3,17
	Efficiency of customs clearance process	2,73	3,12
	Frequency with which shipments reach consignee within scheduled or expected time	3,58	3,77
	Quality of trade and transport-related infrastructure	3,00	3,60
	Overall	3,21	3,41
Italy	Ability to track and trace consignments	3,66	3,83
	Competence and quality of logistics services	3,63	3,74
	Ease of arranging competitively priced shipments	3,57	3,21
	Efficiency of customs clearance process	3,19	3,38
	Frequency with which shipments reach consignee within scheduled or expected time	3,93	4,08
	Quality of trade and transport-related infrastructure	3,52	3,72
	Overall	3,58	3,64

Country Name	Indicator Name	2006	2009
Jamaica	Ability to track and trace consignments	2,24	3,07
	Competence and quality of logistics services	2,07	2,32
	Ease of arranging competitively priced shipments	2,13	2,82
	Efficiency of customs clearance process	2,35	2,00
	Frequency with which shipments reach consignee within scheduled or expected time	2,65	2,82
	Quality of trade and transport-related infrastructure	2,03	2,07
	Overall	2,25	2,53
Japan	Ability to track and trace consignments	4,08	4,13
	Competence and quality of logistics services	4,12	4,00
	Ease of arranging competitively priced shipments	3,77	3,55
	Efficiency of customs clearance process	3,79	3,79
	Frequency with which shipments reach consignee within scheduled or expected time	4,34	4,26
	Quality of trade and transport-related infrastructure	4,11	4,19
	Overall	4,02	3,97
Jordan	Ability to track and trace consignments	2,85	2,33
	Competence and quality of logistics services	3,00	2,49
	Ease of arranging competitively priced shipments	3,08	3,11
	Efficiency of customs clearance process	2,62	2,31
	Frequency with which shipments reach consignee within scheduled or expected time	3,17	3,39
	Quality of trade and transport-related infrastructure	2,62	2,69
	Overall	2,89	2,74
Kazakhstan	Ability to track and trace consignments	2,19	2,70
	Competence and quality of logistics services	2,05	2,60
	Ease of arranging competitively priced shipments	2,10	3,29
	Efficiency of customs clearance process	1,91	2,38
	Frequency with which shipments reach consignee within scheduled or expected time	2,65	3,25
	Quality of trade and transport-related infrastructure	1,86	2,66
	Overall	2,12	2,83
Kenya	Ability to track and trace consignments	2,62	2,89
	Competence and quality of logistics services	2,31	2,28
	Ease of arranging competitively priced shipments	2,79	2,84
	Efficiency of customs clearance process	2,33	2,23
	Frequency with which shipments reach consignee within scheduled or expected time	2,92	3,06
	Quality of trade and transport-related infrastructure	2,15	2,14
	Overall	2,52	2,59

Country Name	Indicator Name	2006	2009
Kiribati	Ability to track and trace consignments	-	-
	Competence and quality of logistics services	-	-
	Ease of arranging competitively priced shipments	-	-
	Efficiency of customs clearance process	-	-
	Frequency with which shipments reach consignee within scheduled or expected time	-	-
	Quality of trade and transport-related infrastructure	-	-
	Overall		
Korea, Dem. Rep.	Ability to track and trace consignments	-	-
	Competence and quality of logistics services	-	-
	Ease of arranging competitively priced shipments	-	-
	Efficiency of customs clearance process	-	-
	Frequency with which shipments reach consignee within scheduled or expected time	-	-
	Quality of trade and transport-related infrastructure	-	-
	Overall		
Korea, Rep.	Ability to track and trace consignments	3,56	3,83
	Competence and quality of logistics services	3,63	3,64
	Ease of arranging competitively priced shipments	3,44	3,47
	Efficiency of customs clearance process	3,22	3,33
	Frequency with which shipments reach consignee within scheduled or expected time	3,86	3,97
	Quality of trade and transport-related infrastructure	3,44	3,62
	Overall	3,52	3,64
Kosovo	Ability to track and trace consignments	-	-
	Competence and quality of logistics services	-	-
	Ease of arranging competitively priced shipments	-	-
	Efficiency of customs clearance process	-	-
	Frequency with which shipments reach consignee within scheduled or expected time	-	-
	Quality of trade and transport-related infrastructure	-	-
	Overall		
Kuwait	Ability to track and trace consignments	3,33	3,44
	Competence and quality of logistics services	3,00	3,11
	Ease of arranging competitively priced shipments	2,60	3,12
	Efficiency of customs clearance process	2,50	3,03
	Frequency with which shipments reach consignee within scheduled or expected time	3,75	3,70
	Quality of trade and transport-related infrastructure	2,83	3,33
	Overall	2,99	3,28

Country Name	Indicator Name	2006	2009
Kyrgyz Republic	Ability to track and trace consignments	2,38	2,33
	Competence and quality of logistics services	2,35	2,37
	Ease of arranging competitively priced shipments	2,35	3,18
	Efficiency of customs clearance process	2,20	2,44
	Frequency with which shipments reach consignee within scheduled or expected time	2,76	3,10
	Quality of trade and transport-related infrastructure	2,06	2,09
	Overall	2,35	2,62
Lao PDR	Ability to track and trace consignments	1,89	2,45
	Competence and quality of logistics services	2,29	2,14
	Ease of arranging competitively priced shipments	2,40	2,70
	Efficiency of customs clearance process	2,08	2,17
	Frequency with which shipments reach consignee within scheduled or expected time	2,83	3,23
	Quality of trade and transport-related infrastructure	2,00	1,95
	Overall	2,25	2,46
Latin America & Caribbean (all income levels)	Ability to track and trace consignments	2,58	2,84
	Competence and quality of logistics services	2,52	2,62
	Ease of arranging competitively priced shipments	2,55	2,70
	Efficiency of customs clearance process	2,38	2,38
	Frequency with which shipments reach consignee within scheduled or expected time	3,02	3,42
	Quality of trade and transport-related infrastructure	2,38	2,45
	Overall	2,57	2,74
Latin America & Caribbean (developing only)	Ability to track and trace consignments	2,58	2,84
	Competence and quality of logistics services	2,52	2,62
	Ease of arranging competitively priced shipments	2,55	2,70
	Efficiency of customs clearance process	2,38	2,38
	Frequency with which shipments reach consignee within scheduled or expected time	3,02	3,41
	Quality of trade and transport-related infrastructure	2,38	2,45
	Overall	2,57	2,74
Latvia	Ability to track and trace consignments	3,06	3,55
	Competence and quality of logistics services	2,94	2,96
	Ease of arranging competitively priced shipments	3,31	3,38
	Efficiency of customs clearance process	2,53	2,94
	Frequency with which shipments reach consignee within scheduled or expected time	3,69	3,72
	Quality of trade and transport-related infrastructure	2,56	2,88
	Overall	3,02	3,25

Country Name	Indicator Name	2006	2009
Least developed countries: UN classification	Ability to track and trace consignments	2,19	2,41
	Competence and quality of logistics services	2,27	2,21
	Ease of arranging competitively priced shipments	2,27	2,47
	Efficiency of customs clearance process	2,10	2,16
	Frequency with which shipments reach consignee within scheduled or expected time	2,67	2,94
	Quality of trade and transport-related infrastructure	2,01	2,01
	Overall	2,25	2,38
Lebanon	Ability to track and trace consignments	2,33	3,16
	Competence and quality of logistics services	2,40	3,73
	Ease of arranging competitively priced shipments	2,50	2,87
	Efficiency of customs clearance process	2,17	3,27
	Frequency with which shipments reach consignee within scheduled or expected time	2,67	3,97
	Quality of trade and transport-related infrastructure	2,14	3,05
	Overall	2,37	3,34
Lesotho	Ability to track and trace consignments	1,83	-
	Competence and quality of logistics services	2,20	-
	Ease of arranging competitively priced shipments	2,50	-
	Efficiency of customs clearance process	2,40	-
	Frequency with which shipments reach consignee within scheduled or expected time	2,83	-
	Quality of trade and transport-related infrastructure	2,00	-
	Overall	2,30	-
Liberia	Ability to track and trace consignments	2,00	2,38
	Competence and quality of logistics services	2,00	2,16
	Ease of arranging competitively priced shipments	2,83	2,33
	Efficiency of customs clearance process	2,40	2,28
	Frequency with which shipments reach consignee within scheduled or expected time	2,43	3,08
	Quality of trade and transport-related infrastructure	2,14	2,00
	Overall	2,31	2,38
Libya	Ability to track and trace consignments	-	2,08
	Competence and quality of logistics services	-	2,28
	Ease of arranging competitively priced shipments	-	2,28
	Efficiency of customs clearance process	-	2,15
	Frequency with which shipments reach consignee within scheduled or expected time	-	2,98
	Quality of trade and transport-related infrastructure	-	2,18
	Overall	-	2,33

Country Name	Indicator Name	2006	2009
Liechtenstein	Ability to track and trace consignments	-	-
	Competence and quality of logistics services	-	-
	Ease of arranging competitively priced shipments	-	-
	Efficiency of customs clearance process	-	-
	Frequency with which shipments reach consignee within scheduled or expected time	-	-
	Quality of trade and transport-related infrastructure	-	-
	Overall		
Lithuania	Ability to track and trace consignments	2,60	3,27
	Competence and quality of logistics services	2,70	2,85
	Ease of arranging competitively priced shipments	3,00	3,19
	Efficiency of customs clearance process	2,64	2,79
	Frequency with which shipments reach consignee within scheduled or expected time	3,40	3,92
	Quality of trade and transport-related infrastructure	2,30	2,72
	Overall	2,78	3,13
Low & middle income	Ability to track and trace consignments	2,40	2,62
	Competence and quality of logistics services	2,39	2,46
	Ease of arranging competitively priced shipments	2,45	2,67
	Efficiency of customs clearance process	2,26	2,29
	Frequency with which shipments reach consignee within scheduled or expected time	2,86	3,17
	Quality of trade and transport-related infrastructure	2,23	2,27
	Overall	2,43	2,59
Low income	Ability to track and trace consignments	2,19	2,40
	Competence and quality of logistics services	2,22	2,21
	Ease of arranging competitively priced shipments	2,26	2,51
	Efficiency of customs clearance process	2,08	2,16
	Frequency with which shipments reach consignee within scheduled or expected time	2,65	2,92
	Quality of trade and transport-related infrastructure	2,01	2,01
	Overall	2,23	2,38
Lower middle income	Ability to track and trace consignments	2,48	2,64
	Competence and quality of logistics services	2,45	2,50
	Ease of arranging competitively priced shipments	2,50	2,67
	Efficiency of customs clearance process	2,31	2,27
	Frequency with which shipments reach consignee within scheduled or expected time	2,94	3,29
	Quality of trade and transport-related infrastructure	2,24	2,31
	Overall	2,49	2,62

Country Name	Indicator Name	2006	2009
Luxembourg	Ability to track and trace consignments	3,56	3,92
	Competence and quality of logistics services	3,22	3,67
	Ease of arranging competitively priced shipments	3,00	3,67
	Efficiency of customs clearance process	3,67	4,04
	Frequency with which shipments reach consignee within scheduled or expected time	4,00	4,58
	Quality of trade and transport-related infrastructure	3,86	4,06
	Overall	3,54	3,98
Macao SAR, China	Ability to track and trace consignments	-	-
	Competence and quality of logistics services	-	-
	Ease of arranging competitively priced shipments	-	-
	Efficiency of customs clearance process	-	-
	Frequency with which shipments reach consignee within scheduled or expected time	-	-
	Quality of trade and transport-related infrastructure	-	-
	Overall		
Macedonia, FYR	Ability to track and trace consignments	2,50	2,82
	Competence and quality of logistics services	2,33	2,76
	Ease of arranging competitively priced shipments	2,67	2,83
	Efficiency of customs clearance process	2,00	2,55
	Frequency with which shipments reach consignee within scheduled or expected time	2,83	3,10
	Quality of trade and transport-related infrastructure	2,29	2,55
	Overall	2,43	2,77
Madagascar	Ability to track and trace consignments	2,19	2,51
	Competence and quality of logistics services	2,00	2,40
	Ease of arranging competitively priced shipments	2,25	3,06
	Efficiency of customs clearance process	2,24	2,35
	Frequency with which shipments reach consignee within scheduled or expected time	2,67	2,90
	Quality of trade and transport-related infrastructure	2,13	2,63
	Overall	2,24	2,66
Malawi	Ability to track and trace consignments	2,00	-
	Competence and quality of logistics services	2,56	-
	Ease of arranging competitively priced shipments	2,56	-
	Efficiency of customs clearance process	2,25	-
	Frequency with which shipments reach consignee within scheduled or expected time	3,00	-
	Quality of trade and transport-related infrastructure	2,13	-
	Overall	2,42	

Country Name	Indicator Name	2006	2009
Malaysia	Ability to track and trace consignments	3,51	3,32
	Competence and quality of logistics services	3,40	3,34
	Ease of arranging competitively priced shipments	3,36	3,50
	Efficiency of customs clearance process	3,36	3,11
	Frequency with which shipments reach consignee within scheduled or expected time	3,95	3,86
	Quality of trade and transport-related infrastructure	3,33	3,50
	Overall	3,48	3,44
Maldives	Ability to track and trace consignments	-	2,42
	Competence and quality of logistics services	-	2,29
	Ease of arranging competitively priced shipments	-	2,42
	Efficiency of customs clearance process	-	2,25
	Frequency with which shipments reach consignee within scheduled or expected time	-	2,83
	Quality of trade and transport-related infrastructure	-	2,16
	Overall		2,40
Mali	Ability to track and trace consignments	2,38	2,31
	Competence and quality of logistics services	2,21	2,13
	Ease of arranging competitively priced shipments	2,23	2,17
	Efficiency of customs clearance process	2,17	2,08
	Frequency with which shipments reach consignee within scheduled or expected time	2,88	2,90
	Quality of trade and transport-related infrastructure	1,90	2,00
	Overall	2,29	2,27
Malta	Ability to track and trace consignments	-	2,56
	Competence and quality of logistics services	-	2,89
	Ease of arranging competitively priced shipments	-	2,91
	Efficiency of customs clearance process	-	2,65
	Frequency with which shipments reach consignee within scheduled or expected time	-	3,02
	Quality of trade and transport-related infrastructure	-	2,89
	Overall		2,82
Marshall Islands	Ability to track and trace consignments	-	-
	Competence and quality of logistics services	-	-
	Ease of arranging competitively priced shipments	-	-
	Efficiency of customs clearance process	-	-
	Frequency with which shipments reach consignee within scheduled or expected time	-	-
	Quality of trade and transport-related infrastructure	-	-
	Overall		

Country Name	Indicator Name	2006	2009
Mauritania	Ability to track and trace consignments	2,80	-
	Competence and quality of logistics services	2,70	-
	Ease of arranging competitively priced shipments	2,60	-
	Efficiency of customs clearance process	2,40	-
	Frequency with which shipments reach consignee within scheduled or expected time	3,10	-
	Quality of trade and transport-related infrastructure	2,20	-
	Overall	2,63	
Mauritius	Ability to track and trace consignments	2,25	2,57
	Competence and quality of logistics services	1,75	2,43
	Ease of arranging competitively priced shipments	2,20	3,24
	Efficiency of customs clearance process	2,00	2,71
	Frequency with which shipments reach consignee within scheduled or expected time	2,33	2,91
	Quality of trade and transport-related infrastructure	2,29	2,29
	Overall	2,13	2,72
Mayotte	Ability to track and trace consignments	-	-
	Competence and quality of logistics services	-	-
	Ease of arranging competitively priced shipments	-	-
	Efficiency of customs clearance process	-	-
	Frequency with which shipments reach consignee within scheduled or expected time	-	-
	Quality of trade and transport-related infrastructure	-	-
	Overall		
Mexico	Ability to track and trace consignments	2,96	3,28
	Competence and quality of logistics services	2,80	3,04
	Ease of arranging competitively priced shipments	2,91	2,83
	Efficiency of customs clearance process	2,50	2,55
	Frequency with which shipments reach consignee within scheduled or expected time	3,40	3,66
	Quality of trade and transport-related infrastructure	2,68	2,95
	Overall	2,87	3,05
Micronesia, Fed. Sts.	Ability to track and trace consignments	-	-
	Competence and quality of logistics services	-	-
	Ease of arranging competitively priced shipments	-	-
	Efficiency of customs clearance process	-	-
	Frequency with which shipments reach consignee within scheduled or expected time	-	-
	Quality of trade and transport-related infrastructure	-	-
	Overall		

Country Name	Indicator Name	2006	2009
Middle East & North Africa (all income levels)	Ability to track and trace consignments	2,67	2,74
	Competence and quality of logistics services	2,60	2,76
	Ease of arranging competitively priced shipments	2,69	2,78
	Efficiency of customs clearance process	2,47	2,60
	Frequency with which shipments reach consignee within scheduled or expected time	3,15	3,45
	Quality of trade and transport-related infrastructure	2,56	2,74
	Overall	2,69	2,85
Middle East & North Africa (developing only)	Ability to track and trace consignments	2,30	2,46
	Competence and quality of logistics services	2,30	2,53
	Ease of arranging competitively priced shipments	2,43	2,65
	Efficiency of customs clearance process	2,20	2,33
	Frequency with which shipments reach consignee within scheduled or expected time	2,77	3,22
	Quality of trade and transport-related infrastructure	2,21	2,36
	Overall	2,37	2,60
Middle income	Ability to track and trace consignments	2,52	2,72
	Competence and quality of logistics services	2,48	2,57
	Ease of arranging competitively priced shipments	2,55	2,74
	Efficiency of customs clearance process	2,36	2,34
	Frequency with which shipments reach consignee within scheduled or expected time	2,97	3,29
	Quality of trade and transport-related infrastructure	2,34	2,39
	Overall	2,53	2,69
Moldova	Ability to track and trace consignments	2,50	3,00
	Competence and quality of logistics services	2,21	2,17
	Ease of arranging competitively priced shipments	2,36	2,83
	Efficiency of customs clearance process	2,14	2,11
	Frequency with which shipments reach consignee within scheduled or expected time	2,73	3,17
	Quality of trade and transport-related infrastructure	1,94	2,05
	Overall	2,31	2,57
Monaco	Ability to track and trace consignments	-	-
	Competence and quality of logistics services	-	-
	Ease of arranging competitively priced shipments	-	-
	Efficiency of customs clearance process	-	-
	Frequency with which shipments reach consignee within scheduled or expected time	-	-
	Quality of trade and transport-related infrastructure	-	-
	Overall	-	-

Country Name	Indicator Name	2006	2009
Mongolia	Ability to track and trace consignments	2,00	2,42
	Competence and quality of logistics services	1,80	2,24
	Ease of arranging competitively priced shipments	2,50	2,46
	Efficiency of customs clearance process	2,00	1,81
	Frequency with which shipments reach consignee within scheduled or expected time	2,25	2,55
	Quality of trade and transport-related infrastructure	1,92	1,94
	Overall	2,08	2,25
Montenegro	Ability to track and trace consignments	-	2,44
	Competence and quality of logistics services	-	2,32
	Ease of arranging competitively priced shipments	-	2,54
	Efficiency of customs clearance process	-	2,17
	Frequency with which shipments reach consignee within scheduled or expected time	-	2,65
	Quality of trade and transport-related infrastructure	-	2,45
	Overall		2,43
Morocco	Ability to track and trace consignments	2,00	-
	Competence and quality of logistics services	2,13	-
	Ease of arranging competitively priced shipments	2,75	-
	Efficiency of customs clearance process	2,20	-
	Frequency with which shipments reach consignee within scheduled or expected time	2,86	-
	Quality of trade and transport-related infrastructure	2,33	-
	Overall	2,38	
Mozambique	Ability to track and trace consignments	2,00	2,28
	Competence and quality of logistics services	2,36	2,20
	Ease of arranging competitively priced shipments	2,25	2,77
	Efficiency of customs clearance process	2,23	1,95
	Frequency with which shipments reach consignee within scheduled or expected time	2,83	2,40
	Quality of trade and transport-related infrastructure	2,08	2,04
	Overall	2,29	2,29
Myanmar	Ability to track and trace consignments	1,57	2,36
	Competence and quality of logistics services	2,00	2,01
	Ease of arranging competitively priced shipments	1,73	2,37
	Efficiency of customs clearance process	2,07	1,94
	Frequency with which shipments reach consignee within scheduled or expected time	2,08	3,29
	Quality of trade and transport-related infrastructure	1,69	1,92
	Overall	1,86	2,33

Country Name	Indicator Name	2006	2009
Namibia	Ability to track and trace consignments	1,83	2,04
	Competence and quality of logistics services	1,83	2,04
	Ease of arranging competitively priced shipments	2,14	2,20
	Efficiency of customs clearance process	2,14	1,68
	Frequency with which shipments reach consignee within scheduled or expected time	3,00	2,38
	Quality of trade and transport-related infrastructure	2,00	1,71
	Overall	2,16	2,02
Nepal	Ability to track and trace consignments	2,33	2,26
	Competence and quality of logistics services	2,08	2,07
	Ease of arranging competitively priced shipments	2,09	2,21
	Efficiency of customs clearance process	1,83	2,07
	Frequency with which shipments reach consignee within scheduled or expected time	2,75	2,74
	Quality of trade and transport-related infrastructure	1,77	1,80
	Overall	2,14	2,20
Netherlands	Ability to track and trace consignments	4,14	4,12
	Competence and quality of logistics services	4,25	4,15
	Ease of arranging competitively priced shipments	4,05	3,61
	Efficiency of customs clearance process	3,99	3,98
	Frequency with which shipments reach consignee within scheduled or expected time	4,38	4,41
	Quality of trade and transport-related infrastructure	4,29	4,25
	Overall	4,18	4,07
Netherlands Antilles	Ability to track and trace consignments	-	-
	Competence and quality of logistics services	-	-
	Ease of arranging competitively priced shipments	-	-
	Efficiency of customs clearance process	-	-
	Frequency with which shipments reach consignee within scheduled or expected time	-	-
	Quality of trade and transport-related infrastructure	-	-
	Overall		
New Caledonia	Ability to track and trace consignments	-	-
	Competence and quality of logistics services	-	-
	Ease of arranging competitively priced shipments	-	-
	Efficiency of customs clearance process	-	-
	Frequency with which shipments reach consignee within scheduled or expected time	-	-
	Quality of trade and transport-related infrastructure	-	-
	Overall		

Country Name	Indicator Name	2006	2009
New Zealand	Ability to track and trace consignments	3,68	3,67
	Competence and quality of logistics services	3,82	3,54
	Ease of arranging competitively priced shipments	3,77	3,36
	Efficiency of customs clearance process	3,57	3,64
	Frequency with which shipments reach consignee within scheduled or expected time	4,05	4,17
	Quality of trade and transport-related infrastructure	3,61	3,54
	Overall	3,75	3,65
Nicaragua	Ability to track and trace consignments	2,19	2,51
	Competence and quality of logistics services	2,41	2,31
	Ease of arranging competitively priced shipments	2,18	2,63
	Efficiency of customs clearance process	2,14	2,24
	Frequency with which shipments reach consignee within scheduled or expected time	2,50	3,21
	Quality of trade and transport-related infrastructure	1,86	2,23
	Overall	2,21	2,54
Niger	Ability to track and trace consignments	2,00	2,45
	Competence and quality of logistics services	2,00	2,42
	Ease of arranging competitively priced shipments	1,80	2,66
	Efficiency of customs clearance process	1,67	2,06
	Frequency with which shipments reach consignee within scheduled or expected time	3,00	3,28
	Quality of trade and transport-related infrastructure	1,40	2,28
	Overall	1,97	2,54
Nigeria	Ability to track and trace consignments	2,36	2,45
	Competence and quality of logistics services	2,38	2,45
	Ease of arranging competitively priced shipments	2,49	2,84
	Efficiency of customs clearance process	2,23	2,17
	Frequency with which shipments reach consignee within scheduled or expected time	2,69	3,10
	Quality of trade and transport-related infrastructure	2,23	2,43
	Overall	2,40	2,59
North America	Ability to track and trace consignments	4,00	4,09
	Competence and quality of logistics services	3,85	3,96
	Ease of arranging competitively priced shipments	3,68	3,23
	Efficiency of customs clearance process	3,67	3,70
	Frequency with which shipments reach consignee within scheduled or expected time	4,15	4,30
	Quality of trade and transport-related infrastructure	4,01	4,09
	Overall	3,88	3,87

Country Name	Indicator Name	2006	2009
Northern Mariana Islands	Ability to track and trace consignments	-	-
	Competence and quality of logistics services	-	-
	Ease of arranging competitively priced shipments	-	-
	Efficiency of customs clearance process	-	-
	Frequency with which shipments reach consignee within scheduled or expected time	-	-
	Quality of trade and transport-related infrastructure	-	-
	Overall		
Norway	Ability to track and trace consignments	3,67	4,10
	Competence and quality of logistics services	3,78	3,85
	Ease of arranging competitively priced shipments	3,62	3,35
	Efficiency of customs clearance process	3,76	3,86
	Frequency with which shipments reach consignee within scheduled or expected time	4,24	4,35
	Quality of trade and transport-related infrastructure	3,82	4,22
	Overall	3,81	3,93
OECD members	Ability to track and trace consignments	3,69	3,79
	Competence and quality of logistics services	3,64	3,63
	Ease of arranging competitively priced shipments	3,49	3,33
	Efficiency of customs clearance process	3,45	3,46
	Frequency with which shipments reach consignee within scheduled or expected time	4,02	4,12
	Quality of trade and transport-related infrastructure	3,60	3,67
	Overall	3,64	3,66
Oman	Ability to track and trace consignments	2,80	2,04
	Competence and quality of logistics services	2,67	2,37
	Ease of arranging competitively priced shipments	2,57	2,31
	Efficiency of customs clearance process	2,71	3,38
	Frequency with which shipments reach consignee within scheduled or expected time	4,00	3,94
	Quality of trade and transport-related infrastructure	2,86	3,06
	Overall	2,92	2,84
Pakistan	Ability to track and trace consignments	2,57	2,64
	Competence and quality of logistics services	2,71	2,28
	Ease of arranging competitively priced shipments	2,72	2,91
	Efficiency of customs clearance process	2,41	2,05
	Frequency with which shipments reach consignee within scheduled or expected time	2,93	3,08
	Quality of trade and transport-related infrastructure	2,37	2,08
	Overall	2,62	2,53

Country Name	Indicator Name	2006	2009
Palau	Ability to track and trace consignments	-	-
	Competence and quality of logistics services	-	-
	Ease of arranging competitively priced shipments	-	-
	Efficiency of customs clearance process	-	-
	Frequency with which shipments reach consignee within scheduled or expected time	-	-
	Quality of trade and transport-related infrastructure	-	-
	Overall		
Panama	Ability to track and trace consignments	2,93	3,26
	Competence and quality of logistics services	2,73	2,83
	Ease of arranging competitively priced shipments	2,80	2,87
	Efficiency of customs clearance process	2,68	2,76
	Frequency with which shipments reach consignee within scheduled or expected time	3,43	3,76
	Quality of trade and transport-related infrastructure	2,79	2,63
	Overall	2,89	3,02
Papua New Guinea	Ability to track and trace consignments	2,29	2,43
	Competence and quality of logistics services	2,29	2,20
	Ease of arranging competitively priced shipments	2,57	2,55
	Efficiency of customs clearance process	2,00	2,02
	Frequency with which shipments reach consignee within scheduled or expected time	3,14	3,24
	Quality of trade and transport-related infrastructure	2,00	1,91
	Overall	2,38	2,41
Paraguay	Ability to track and trace consignments	2,67	2,72
	Competence and quality of logistics services	2,63	2,59
	Ease of arranging competitively priced shipments	2,29	2,87
	Efficiency of customs clearance process	2,20	2,37
	Frequency with which shipments reach consignee within scheduled or expected time	3,23	3,46
	Quality of trade and transport-related infrastructure	2,47	2,44
	Overall	2,57	2,75
Peru	Ability to track and trace consignments	2,70	2,89
	Competence and quality of logistics services	2,73	2,61
	Ease of arranging competitively priced shipments	2,91	2,75
	Efficiency of customs clearance process	2,68	2,50
	Frequency with which shipments reach consignee within scheduled or expected time	3,00	3,38
	Quality of trade and transport-related infrastructure	2,57	2,66
	Overall	2,77	2,80

Country Name	Indicator Name	2006	2009
Philippines	Ability to track and trace consignments	2,65	3,29
	Competence and quality of logistics services	2,65	2,95
	Ease of arranging competitively priced shipments	2,77	3,40
	Efficiency of customs clearance process	2,64	2,67
	Frequency with which shipments reach consignee within scheduled or expected time	3,14	3,83
	Quality of trade and transport-related infrastructure	2,26	2,57
	Overall	2,69	3,14
Poland	Ability to track and trace consignments	3,12	3,45
	Competence and quality of logistics services	3,04	3,26
	Ease of arranging competitively priced shipments	2,92	3,22
	Efficiency of customs clearance process	2,88	3,12
	Frequency with which shipments reach consignee within scheduled or expected time	3,59	4,52
	Quality of trade and transport-related infrastructure	2,69	2,98
	Overall	3,04	3,44
Portugal	Ability to track and trace consignments	3,44	3,38
	Competence and quality of logistics services	3,19	3,31
	Ease of arranging competitively priced shipments	3,23	3,02
	Efficiency of customs clearance process	3,24	3,31
	Frequency with which shipments reach consignee within scheduled or expected time	4,06	3,84
	Quality of trade and transport-related infrastructure	3,16	3,17
	Overall	3,38	3,34
Puerto Rico	Ability to track and trace consignments	-	-
	Competence and quality of logistics services	-	-
	Ease of arranging competitively priced shipments	-	-
	Efficiency of customs clearance process	-	-
	Frequency with which shipments reach consignee within scheduled or expected time	-	-
	Quality of trade and transport-related infrastructure	-	-
	Overall		
Qatar	Ability to track and trace consignments	3,17	3,09
	Competence and quality of logistics services	3,00	2,57
	Ease of arranging competitively priced shipments	3,00	2,92
	Efficiency of customs clearance process	2,44	2,25
	Frequency with which shipments reach consignee within scheduled or expected time	3,67	4,09
	Quality of trade and transport-related infrastructure	2,63	2,75
	Overall	2,98	2,95

Country Name	Indicator Name	2006	2009
Romania	Ability to track and trace consignments	2,86	2,90
	Competence and quality of logistics services	2,86	2,68
	Ease of arranging competitively priced shipments	3,20	3,24
	Efficiency of customs clearance process	2,60	2,36
	Frequency with which shipments reach consignee within scheduled or expected time	3,18	3,45
	Quality of trade and transport-related infrastructure	2,73	2,25
	Overall	2,91	2,84
Russian Federation	Ability to track and trace consignments	2,17	2,60
	Competence and quality of logistics services	2,46	2,51
	Ease of arranging competitively priced shipments	2,48	2,72
	Efficiency of customs clearance process	1,94	2,15
	Frequency with which shipments reach consignee within scheduled or expected time	2,94	3,23
	Quality of trade and transport-related infrastructure	2,23	2,38
	Overall	2,37	2,61
Rwanda	Ability to track and trace consignments	1,60	1,99
	Competence and quality of logistics services	1,67	1,85
	Ease of arranging competitively priced shipments	1,67	2,88
	Efficiency of customs clearance process	1,80	1,63
	Frequency with which shipments reach consignee within scheduled or expected time	2,38	2,05
	Quality of trade and transport-related infrastructure	1,53	1,63
	Overall	1,77	2,04
Samoa	Ability to track and trace consignments	-	-
	Competence and quality of logistics services	-	-
	Ease of arranging competitively priced shipments	-	-
	Efficiency of customs clearance process	-	-
	Frequency with which shipments reach consignee within scheduled or expected time	-	-
	Quality of trade and transport-related infrastructure	-	-
	Overall	-	-
San Marino	Ability to track and trace consignments	-	-
	Competence and quality of logistics services	-	-
	Ease of arranging competitively priced shipments	-	-
	Efficiency of customs clearance process	-	-
	Frequency with which shipments reach consignee within scheduled or expected time	-	-
	Quality of trade and transport-related infrastructure	-	-
	Overall	-	-

Country Name	Indicator Name	2006	2009
Sao Tome and Principe	Ability to track and trace consignments	3,00	-
	Competence and quality of logistics services	3,00	-
	Ease of arranging competitively priced shipments	3,40	-
	Efficiency of customs clearance process	2,50	-
	Frequency with which shipments reach consignee within scheduled or expected time	3,00	-
	Quality of trade and transport-related infrastructure	2,20	-
	Overall	2,86	
Saudi Arabia	Ability to track and trace consignments	3,02	3,32
	Competence and quality of logistics services	2,88	3,33
	Ease of arranging competitively priced shipments	2,93	2,80
	Efficiency of customs clearance process	2,72	2,91
	Frequency with which shipments reach consignee within scheduled or expected time	3,65	3,78
	Quality of trade and transport-related infrastructure	2,95	3,27
	Overall	3,02	3,22
Senegal	Ability to track and trace consignments	2,30	3,08
	Competence and quality of logistics services	2,73	2,73
	Ease of arranging competitively priced shipments	2,09	2,75
	Efficiency of customs clearance process	2,38	2,45
	Frequency with which shipments reach consignee within scheduled or expected time	2,63	3,52
	Quality of trade and transport-related infrastructure	2,09	2,64
	Overall	2,37	2,86
Serbia	Ability to track and trace consignments	2,07	2,67
	Competence and quality of logistics services	2,29	2,55
	Ease of arranging competitively priced shipments	2,25	3,41
	Efficiency of customs clearance process	2,33	2,19
	Frequency with which shipments reach consignee within scheduled or expected time	2,54	2,80
	Quality of trade and transport-related infrastructure	2,18	2,30
	Overall	2,28	2,69
Seychelles	Ability to track and trace consignments	-	-
	Competence and quality of logistics services	-	-
	Ease of arranging competitively priced shipments	-	-
	Efficiency of customs clearance process	-	-
	Frequency with which shipments reach consignee within scheduled or expected time	-	-
	Quality of trade and transport-related infrastructure	-	-
	Overall		

Country Name	Indicator Name	2006	2009
Sierra Leone	Ability to track and trace consignments	2,00	1,73
	Competence and quality of logistics services	1,91	1,53
	Ease of arranging competitively priced shipments	1,82	2,33
	Efficiency of customs clearance process	1,58	2,17
	Frequency with which shipments reach consignee within scheduled or expected time	2,64	2,33
	Quality of trade and transport-related infrastructure	1,83	1,61
	Overall	1,95	1,97
Singapore	Ability to track and trace consignments	4,25	4,15
	Competence and quality of logistics services	4,21	4,12
	Ease of arranging competitively priced shipments	4,04	3,86
	Efficiency of customs clearance process	3,90	4,02
	Frequency with which shipments reach consignee within scheduled or expected time	4,53	4,23
	Quality of trade and transport-related infrastructure	4,27	4,22
	Overall	4,19	4,09
Slovak Republic	Ability to track and trace consignments	2,87	3,54
	Competence and quality of logistics services	3,00	3,15
	Ease of arranging competitively priced shipments	3,09	3,05
	Efficiency of customs clearance process	2,61	2,79
	Frequency with which shipments reach consignee within scheduled or expected time	3,26	3,92
	Quality of trade and transport-related infrastructure	2,68	3,00
	Overall	2,92	3,24
Slovenia	Ability to track and trace consignments	2,91	3,16
	Competence and quality of logistics services	3,09	2,90
	Ease of arranging competitively priced shipments	3,14	2,84
	Efficiency of customs clearance process	2,79	2,59
	Frequency with which shipments reach consignee within scheduled or expected time	3,73	3,10
	Quality of trade and transport-related infrastructure	3,22	2,65
	Overall	3,14	2,87
Solomon Islands	Ability to track and trace consignments	2,00	2,03
	Competence and quality of logistics services	2,10	2,27
	Ease of arranging competitively priced shipments	2,36	2,18
	Efficiency of customs clearance process	1,73	2,08
	Frequency with which shipments reach consignee within scheduled or expected time	2,30	3,05
	Quality of trade and transport-related infrastructure	2,00	2,23
	Overall	2,08	2,31

Country Name	Indicator Name	2006	2009
Somalia	Ability to track and trace consignments	1,75	1,17
	Competence and quality of logistics services	2,25	1,33
	Ease of arranging competitively priced shipments	1,88	1,33
	Efficiency of customs clearance process	2,43	1,33
	Frequency with which shipments reach consignee within scheduled or expected time	3,00	1,38
	Quality of trade and transport-related infrastructure	1,63	1,50
	Overall	2,16	1,34
South Africa	Ability to track and trace consignments	3,71	3,73
	Competence and quality of logistics services	3,54	3,59
	Ease of arranging competitively priced shipments	3,56	3,26
	Efficiency of customs clearance process	3,22	3,22
	Frequency with which shipments reach consignee within scheduled or expected time	3,78	3,57
	Quality of trade and transport-related infrastructure	3,42	3,42
	Overall	3,53	3,46
South Asia	Ability to track and trace consignments	2,32	2,53
	Competence and quality of logistics services	2,32	2,33
	Ease of arranging competitively priced shipments	2,28	2,60
	Efficiency of customs clearance process	2,06	2,22
	Frequency with which shipments reach consignee within scheduled or expected time	2,73	3,04
	Quality of trade and transport-related infrastructure	2,07	2,13
	Overall	2,30	2,49
Spain	Ability to track and trace consignments	3,63	3,96
	Competence and quality of logistics services	3,55	3,62
	Ease of arranging competitively priced shipments	3,45	3,11
	Efficiency of customs clearance process	3,17	3,47
	Frequency with which shipments reach consignee within scheduled or expected time	3,86	4,12
	Quality of trade and transport-related infrastructure	3,51	3,58
	Overall	3,52	3,63
Sri Lanka	Ability to track and trace consignments	2,58	2,23
	Competence and quality of logistics services	2,45	2,09
	Ease of arranging competitively priced shipments	2,31	2,48
	Efficiency of customs clearance process	2,25	1,96
	Frequency with which shipments reach consignee within scheduled or expected time	2,69	2,98
	Quality of trade and transport-related infrastructure	2,13	1,88
	Overall	2,40	2,29

Country Name	Indicator Name	2006	2009
St. Kitts and Nevis	Ability to track and trace consignments	-	-
	Competence and quality of logistics services	-	-
	Ease of arranging competitively priced shipments	-	-
	Efficiency of customs clearance process	-	-
	Frequency with which shipments reach consignee within scheduled or expected time	-	-
	Quality of trade and transport-related infrastructure	-	-
	Overall		
St. Lucia	Ability to track and trace consignments	-	-
	Competence and quality of logistics services	-	-
	Ease of arranging competitively priced shipments	-	-
	Efficiency of customs clearance process	-	-
	Frequency with which shipments reach consignee within scheduled or expected time	-	-
	Quality of trade and transport-related infrastructure	-	-
	Overall		
St. Vincent and the Grenadines	Ability to track and trace consignments	-	-
	Competence and quality of logistics services	-	-
	Ease of arranging competitively priced shipments	-	-
	Efficiency of customs clearance process	-	-
	Frequency with which shipments reach consignee within scheduled or expected time	-	-
	Quality of trade and transport-related infrastructure	-	-
	Overall		
Sub-Saharan Africa (all income levels)	Ability to track and trace consignments	2,31	2,49
	Competence and quality of logistics services	2,33	2,28
	Ease of arranging competitively priced shipments	2,36	2,51
	Efficiency of customs clearance process	2,21	2,18
	Frequency with which shipments reach consignee within scheduled or expected time	2,77	2,94
	Quality of trade and transport-related infrastructure	2,11	2,05
	Overall	2,35	2,42
Sub-Saharan Africa (developing only)	Ability to track and trace consignments	2,31	2,49
	Competence and quality of logistics services	2,33	2,28
	Ease of arranging competitively priced shipments	2,36	2,51
	Efficiency of customs clearance process	2,21	2,18
	Frequency with which shipments reach consignee within scheduled or expected time	2,77	2,94
	Quality of trade and transport-related infrastructure	2,11	2,05
	Overall	2,35	2,42

Country Name	Indicator Name	2006	2009
Sudan	Ability to track and trace consignments	2,92	2,02
	Competence and quality of logistics services	2,83	2,15
	Ease of arranging competitively priced shipments	2,67	2,11
	Efficiency of customs clearance process	2,36	2,02
	Frequency with which shipments reach consignee within scheduled or expected time	3,17	3,09
	Quality of trade and transport-related infrastructure	2,36	1,78
	Overall	2,71	2,21
Suriname	Ability to track and trace consignments	-	-
	Competence and quality of logistics services	-	-
	Ease of arranging competitively priced shipments	-	-
	Efficiency of customs clearance process	-	-
	Frequency with which shipments reach consignee within scheduled or expected time	-	-
	Quality of trade and transport-related infrastructure	-	-
	Overall		
Swaziland	Ability to track and trace consignments	-	-
	Competence and quality of logistics services	-	-
	Ease of arranging competitively priced shipments	-	-
	Efficiency of customs clearance process	-	-
	Frequency with which shipments reach consignee within scheduled or expected time	-	-
	Quality of trade and transport-related infrastructure	-	-
	Overall		
Sweden	Ability to track and trace consignments	4,15	4,22
	Competence and quality of logistics services	4,06	4,22
	Ease of arranging competitively priced shipments	3,90	3,83
	Efficiency of customs clearance process	3,85	3,88
	Frequency with which shipments reach consignee within scheduled or expected time	4,43	4,32
	Quality of trade and transport-related infrastructure	4,11	4,03
	Overall	4,08	4,08
Switzerland	Ability to track and trace consignments	4,04	4,27
	Competence and quality of logistics services	4,00	4,32
	Ease of arranging competitively priced shipments	3,67	3,32
	Efficiency of customs clearance process	3,85	3,73
	Frequency with which shipments reach consignee within scheduled or expected time	4,48	4,20
	Quality of trade and transport-related infrastructure	4,13	4,17
	Overall	4,02	3,97

Country Name	Indicator Name	2006	2009
Syrian Arab Republic	Ability to track and trace consignments	2,00	2,63
	Competence and quality of logistics services	1,80	2,59
	Ease of arranging competitively priced shipments	2,00	2,87
	Efficiency of customs clearance process	2,17	2,37
	Frequency with which shipments reach consignee within scheduled or expected time	2,67	3,45
	Quality of trade and transport-related infrastructure	1,91	2,45
	Overall	2,09	2,74
Tajikistan	Ability to track and trace consignments	1,67	2,25
	Competence and quality of logistics services	1,90	2,25
	Ease of arranging competitively priced shipments	2,00	2,42
	Efficiency of customs clearance process	1,91	1,90
	Frequency with which shipments reach consignee within scheduled or expected time	2,11	3,16
	Quality of trade and transport-related infrastructure	2,00	2,00
	Overall	1,93	2,35
Tanzania	Ability to track and trace consignments	2,17	2,56
	Competence and quality of logistics services	1,92	2,38
	Ease of arranging competitively priced shipments	2,08	2,78
	Efficiency of customs clearance process	2,07	2,42
	Frequency with which shipments reach consignee within scheduled or expected time	2,27	3,33
	Quality of trade and transport-related infrastructure	2,00	2,00
	Overall	2,08	2,60
Thailand	Ability to track and trace consignments	3,25	3,41
	Competence and quality of logistics services	3,31	3,16
	Ease of arranging competitively priced shipments	3,24	3,27
	Efficiency of customs clearance process	3,03	3,02
	Frequency with which shipments reach consignee within scheduled or expected time	3,91	3,73
	Quality of trade and transport-related infrastructure	3,16	3,16
	Overall	3,31	3,29
Timor-Leste	Ability to track and trace consignments	1,67	-
	Competence and quality of logistics services	1,60	-
	Ease of arranging competitively priced shipments	1,50	-
	Efficiency of customs clearance process	1,63	-
	Frequency with which shipments reach consignee within scheduled or expected time	2,25	-
	Quality of trade and transport-related infrastructure	1,67	-
	Overall	1,71	-

Country Name	Indicator Name	2006	2009
Togo	Ability to track and trace consignments	2,20	3,42
	Competence and quality of logistics services	2,40	2,45
	Ease of arranging competitively priced shipments	2,40	2,42
	Efficiency of customs clearance process	2,10	2,40
	Frequency with which shipments reach consignee within scheduled or expected time	2,11	3,02
	Quality of trade and transport-related infrastructure	2,25	1,82
	Overall	2,25	2,60
Tonga	Ability to track and trace consignments	-	-
	Competence and quality of logistics services	-	-
	Ease of arranging competitively priced shipments	-	-
	Efficiency of customs clearance process	-	-
	Frequency with which shipments reach consignee within scheduled or expected time	-	-
	Quality of trade and transport-related infrastructure	-	-
	Overall		
Trinidad and Tobago	Ability to track and trace consignments	-	-
	Competence and quality of logistics services	-	-
	Ease of arranging competitively priced shipments	-	-
	Efficiency of customs clearance process	-	-
	Frequency with which shipments reach consignee within scheduled or expected time	-	-
	Quality of trade and transport-related infrastructure	-	-
	Overall		
Tunisia	Ability to track and trace consignments	2,83	2,56
	Competence and quality of logistics services	2,43	2,36
	Ease of arranging competitively priced shipments	2,86	3,36
	Efficiency of customs clearance process	2,83	2,43
	Frequency with which shipments reach consignee within scheduled or expected time	2,80	3,57
	Quality of trade and transport-related infrastructure	2,83	2,56
	Overall	2,76	2,84
Turkey	Ability to track and trace consignments	3,27	3,09
	Competence and quality of logistics services	3,29	3,23
	Ease of arranging competitively priced shipments	3,07	3,15
	Efficiency of customs clearance process	3,00	2,82
	Frequency with which shipments reach consignee within scheduled or expected time	3,38	3,94
	Quality of trade and transport-related infrastructure	2,94	3,08
	Overall	3,15	3,22

Country Name	Indicator Name	2006	2009
Turkmenistan	Ability to track and trace consignments	-	2,38
	Competence and quality of logistics services	-	2,34
	Ease of arranging competitively priced shipments	-	2,31
	Efficiency of customs clearance process	-	2,14
	Frequency with which shipments reach consignee within scheduled or expected time	-	3,51
	Quality of trade and transport-related infrastructure	-	2,24
	Overall		2,49
Turks and Caicos Islands	Ability to track and trace consignments	-	-
	Competence and quality of logistics services	-	-
	Ease of arranging competitively priced shipments	-	-
	Efficiency of customs clearance process	-	-
	Frequency with which shipments reach consignee within scheduled or expected time	-	-
	Quality of trade and transport-related infrastructure	-	-
	Overall		
Tuvalu	Ability to track and trace consignments	-	-
	Competence and quality of logistics services	-	-
	Ease of arranging competitively priced shipments	-	-
	Efficiency of customs clearance process	-	-
	Frequency with which shipments reach consignee within scheduled or expected time	-	-
	Quality of trade and transport-related infrastructure	-	-
	Overall		
Uganda	Ability to track and trace consignments	2,33	2,45
	Competence and quality of logistics services	2,55	2,59
	Ease of arranging competitively priced shipments	2,42	3,02
	Efficiency of customs clearance process	2,21	2,84
	Frequency with which shipments reach consignee within scheduled or expected time	3,29	3,52
	Quality of trade and transport-related infrastructure	2,17	2,35
	Overall	2,49	2,82
Ukraine	Ability to track and trace consignments	2,53	2,49
	Competence and quality of logistics services	2,41	2,59
	Ease of arranging competitively priced shipments	2,53	2,79
	Efficiency of customs clearance process	2,22	2,02
	Frequency with which shipments reach consignee within scheduled or expected time	3,31	3,06
	Quality of trade and transport-related infrastructure	2,35	2,44
	Overall	2,55	2,57

Country Name	Indicator Name	2006	2009
United Arab Emirates	Ability to track and trace consignments	3,61	3,58
	Competence and quality of logistics services	3,67	3,53
	Ease of arranging competitively priced shipments	3,68	3,48
	Efficiency of customs clearance process	3,52	3,49
	Frequency with which shipments reach consignee within scheduled or expected time	4,12	3,94
	Quality of trade and transport-related infrastructure	3,80	3,81
	Overall	3,73	3,63
United Kingdom	Ability to track and trace consignments	4,10	4,13
	Competence and quality of logistics services	4,02	3,92
	Ease of arranging competitively priced shipments	3,85	3,66
	Efficiency of customs clearance process	3,74	3,74
	Frequency with which shipments reach consignee within scheduled or expected time	4,25	4,37
	Quality of trade and transport-related infrastructure	4,05	3,95
	Overall	3,99	3,95
United States	Ability to track and trace consignments	4,01	4,17
	Competence and quality of logistics services	3,85	3,92
	Ease of arranging competitively priced shipments	3,58	3,21
	Efficiency of customs clearance process	3,52	3,68
	Frequency with which shipments reach consignee within scheduled or expected time	4,11	4,19
	Quality of trade and transport-related infrastructure	4,07	4,15
	Overall	3,84	3,86
Upper middle income	Ability to track and trace consignments	2,57	2,81
	Competence and quality of logistics services	2,52	2,65
	Ease of arranging competitively priced shipments	2,60	2,82
	Efficiency of customs clearance process	2,42	2,42
	Frequency with which shipments reach consignee within scheduled or expected time	3,01	3,29
	Quality of trade and transport-related infrastructure	2,45	2,48
	Overall	2,59	2,75
Uruguay	Ability to track and trace consignments	2,57	2,78
	Competence and quality of logistics services	2,45	2,59
	Ease of arranging competitively priced shipments	2,40	2,77
	Efficiency of customs clearance process	2,29	2,71
	Frequency with which shipments reach consignee within scheduled or expected time	3,00	3,06
	Quality of trade and transport-related infrastructure	2,38	2,58
	Overall	2,51	2,75

Country Name	Indicator Name	2006	2009
Uzbekistan	Ability to track and trace consignments	2,08	2,96
	Competence and quality of logistics services	2,15	2,50
	Ease of arranging competitively priced shipments	2,07	2,79
	Efficiency of customs clearance process	1,94	2,20
	Frequency with which shipments reach consignee within scheduled or expected time	2,73	3,72
	Quality of trade and transport-related infrastructure	2,00	2,54
	Overall	2,16	2,79
Vanuatu	Ability to track and trace consignments	-	-
	Competence and quality of logistics services	-	-
	Ease of arranging competitively priced shipments	-	-
	Efficiency of customs clearance process	-	-
	Frequency with which shipments reach consignee within scheduled or expected time	-	-
	Quality of trade and transport-related infrastructure	-	-
	Overall		
Venezuela, RB	Ability to track and trace consignments	2,54	2,84
	Competence and quality of logistics services	2,59	2,53
	Ease of arranging competitively priced shipments	2,69	3,05
	Efficiency of customs clearance process	2,37	2,06
	Frequency with which shipments reach consignee within scheduled or expected time	3,03	3,05
	Quality of trade and transport-related infrastructure	2,51	2,44
	Overall	2,62	2,68
Vietnam	Ability to track and trace consignments	2,90	3,10
	Competence and quality of logistics services	2,80	2,89
	Ease of arranging competitively priced shipments	3,00	3,04
	Efficiency of customs clearance process	2,89	2,68
	Frequency with which shipments reach consignee within scheduled or expected time	3,22	3,44
	Quality of trade and transport-related infrastructure	2,50	2,56
	Overall	2,89	2,96
Virgin Islands (U.S.)	Ability to track and trace consignments	-	-
	Competence and quality of logistics services	-	-
	Ease of arranging competitively priced shipments	-	-
	Efficiency of customs clearance process	-	-
	Frequency with which shipments reach consignee within scheduled or expected time	-	-
	Quality of trade and transport-related infrastructure	-	-
	Overall		

Country Name	Indicator Name	2006	2009
West Bank and Gaza	Ability to track and trace consignments	-	-
	Competence and quality of logistics services	-	-
	Ease of arranging competitively priced shipments	-	-
	Efficiency of customs clearance process	-	-
	Frequency with which shipments reach consignee within scheduled or expected time	-	-
	Quality of trade and transport-related infrastructure	-	-
	Overall		
World	Ability to track and trace consignments	2,73	2,92
	Competence and quality of logistics services	2,71	2,76
	Ease of arranging competitively priced shipments	2,72	2,85
	Efficiency of customs clearance process	2,56	2,59
	Frequency with which shipments reach consignee within scheduled or expected time	3,17	3,41
	Quality of trade and transport-related infrastructure	2,58	2,64
	Overall	2,74	2,87
Yemen, Rep.	Ability to track and trace consignments	2,30	2,63
	Competence and quality of logistics services	2,22	2,35
	Ease of arranging competitively priced shipments	2,20	2,24
	Efficiency of customs clearance process	2,18	2,46
	Frequency with which shipments reach consignee within scheduled or expected time	2,78	3,48
	Quality of trade and transport-related infrastructure	2,08	2,35
	Overall	2,29	2,58
Zambia	Ability to track and trace consignments	2,80	2,35
	Competence and quality of logistics services	2,44	2,01
	Ease of arranging competitively priced shipments	2,40	2,41
	Efficiency of customs clearance process	2,08	2,17
	Frequency with which shipments reach consignee within scheduled or expected time	2,50	2,85
	Quality of trade and transport-related infrastructure	2,00	1,83
	Overall	2,37	2,28
Zimbabwe	Ability to track and trace consignments	2,64	-
	Competence and quality of logistics services	2,21	-
	Ease of arranging competitively priced shipments	2,27	-
	Efficiency of customs clearance process	1,92	-
	Frequency with which shipments reach consignee within scheduled or expected time	2,85	-
	Quality of trade and transport-related infrastructure	1,87	-
	Overall	2,29	

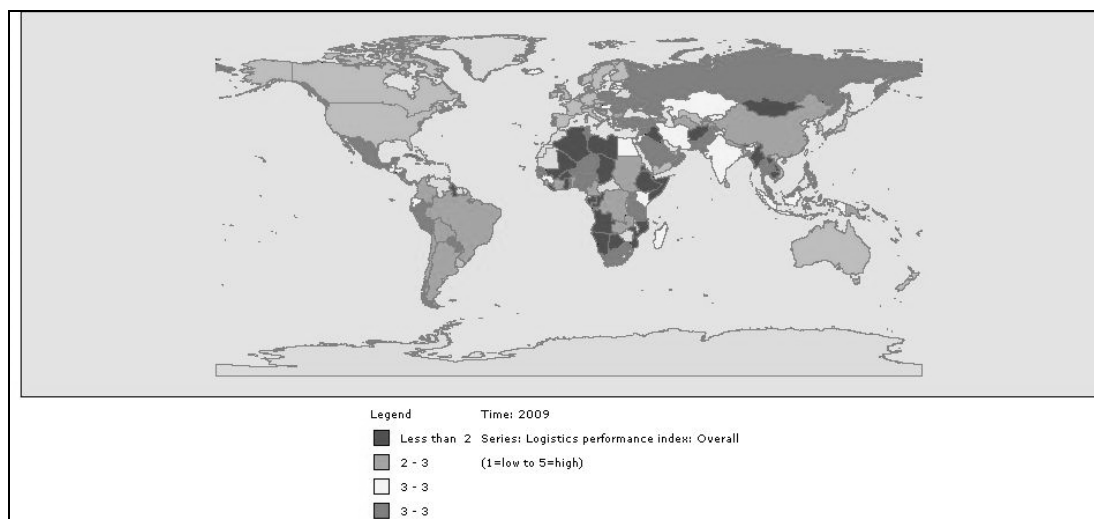

Figure App.C. 1 – World Map data of logistics performance index in year 2009. (Source: The World Bank)

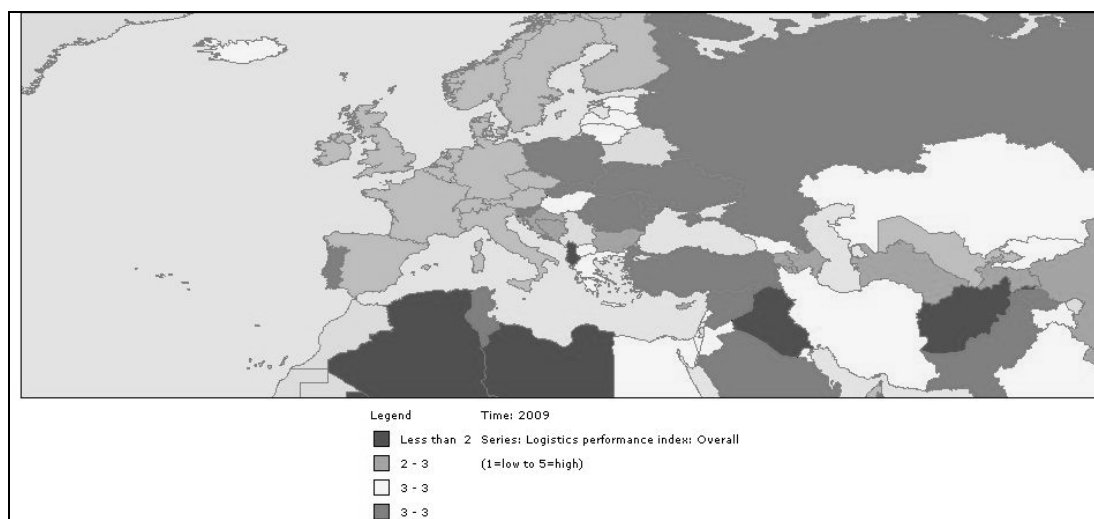

Figure App.C. 2 – Euro area map data of logistics performance index in year 2009. (Source: The World Bank)